



INSTRUCTION MANUAL

LIMITED WARRANTY

We promise to repair or replace any chair that is found to be defective in material or workmanship within one year from the date of original purchase so long as you, the original purchaser, still owns it. This is your sole and exclusive remedy. This warranty is subject to the provisions below.

EXCLUSIONS

This warranty does not apply and no other warranty applies to:

- Normal wear and tear, which are to be expected over the course of ownership.
- Misuse, abuse, or excessive use of the product.
- Modifications or attachments to the product that are not approved by us.
- Products that were not installed, used, or maintained in accordance with product instructions and warnings.
- Products used for rental purposes or unauthorized retail activities.

Seating Usage: Normal use for seating is identified as the equivalent of a single shift, forty-(40) hour workweek. To the extent that a seating product is used in a manner exceeding this, the applicable warranty period will be reduced in a pro-rata manner.

RETURN POLICY

We adopt a 30-day return policy which means that all products purchased on this website may be returned to us within the timeframe. You need to contact us within 30 days after the product(s) came into your possession and the product(s) must be returned to us without any undue delays.

Returned products must be returned in the same condition as they were sent and they must be sent in their original packaging.

If the product is not faulty, (i.e. if you changed your mind or if you are unhappy with the product for some other reason), the cost of shipping will fall on you. And it is your responsibility that the package arrives safely to us so we recommend that you use a courier service where it is possible to track the shipment.

If the product is faulty when you receive it, please contact us and we will help you out.

We reserve the right to give a partial refund in cases when the product(s) is not in an unused condition, is damaged or has missing parts, not due to our error.

HOW RETURNS WORK

To request a return, please fill out the contact form on our website and attach a copy of your invoice as proof of purchase and the reason for your return in the message.

Then we will provide the return address for the product as soon as possible.

Once the returned product has been received by us and inspections have been completed, a specific disposition will be provided to you.

In addition, if the return is approved, the refund amount will be automatically credited to your original payment method.

LIMITED WARRANTY

WARNING

 Please read the instructions carefully and follow the assembly steps.

To ensure proper assembly, please follow all steps and use all parts provided. Not following this warning may result in serious injury to you or others.

To prevent misalignments, keep the screws loose and do not tighten them until they are all in their correct positions.

Avoid overtightening or forcing the screws, as this could cause them to break, strip, or damage the threads of the holes.

Using the wrong size of screws for a particular part could cause damage to the screw or the part.

Please lubricate all moving parts regularly and tighten all bolts and screws every 6 months, or as needed.

PRODUCT FEATURES

Pneumatic Seat Height Adjustment



Pulling the lever upwards enables height adjustment of the seat, then the seat can be locked at a fixed height by releasing the lever.

Rock Tension Adjustment



Simply adjust the knob counterclockwise to tighten the tension of rocking. Or loosen the tension by turning the knob clockwise whenever needed.

Seat Back Locking Mechanism



Simply press the lever down to lock the seat in an upright position.

SAFETY INFORMATION

WEIGHT CAPACITY FOR SEATING: 300LBS



Sit in the center of the chair with your back against the backrest



Do not sit at the front edge of the chair



Do not stand on the chair



Do not use the chair with more than one person



Do not push the chair around when a person is sitting in it



Do not push down on the backrest when a person is reclined



Do not place all your weight on the backrest only

ASSEMBLY PARTS AND TOOL

BEFORE YOU GET STARTED, A FEW POINTERS:



Having a friend to help makes assembly extra-easy



Mind the important safety information

1



Back Cushion *1

2

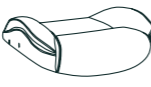

Seat Cushion *1

3



Arms *2

4

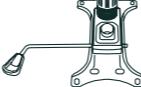

Seat Plate *1

5



Gas Lift *1

6

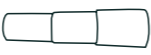

Gas Lift Cover *1

7



Star Base *1

8



Casters *5

9



Bolts M6*20mm *2

10



Bolts M6*25mm *2

11



Bolts M8*25mm *8

12



Plastic Caps *8

13



Wrench *1

PLEASE MAKE SURE ALL THE PARTS ARE INCLUDED.

MISSING PARTS? support@colamyhome.com

ASSEMBLY INSTRUCTIONS

Step 1

Turn the Star Base(7) upside down, then press the Casters(8) into the holes at the end of each base leg, insert the Gas Lift(5) into the center hole of the Star Base, the Gas Lift Cover(6) should be placed over the Gas Lift(5).

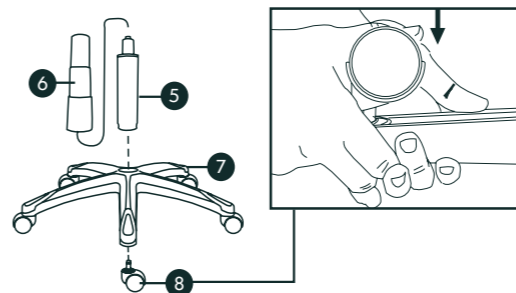

Step 2

Align the Seat Plate(4) over the pre-drilled holes underneath the Seat Cushion(2), make sure that the front of the Seat Plate is facing the front of the Seat Cushion. Attach the Seat Plate to the Seat Cushion using TWO Bolts M6*25mm(10) at the front and TWO Bolts M6*20mm(9) at the back, tighten all the bolts with the Wrench(13), being careful not to miss-thread the bolts or damage the seat.

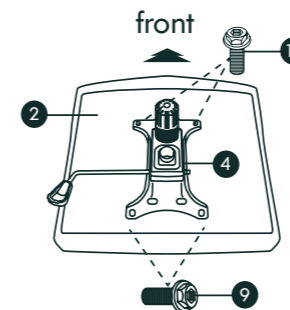

Step 3

Turn the Seat Cushion(2) upright and align the center hole of the Seat Plate(4) over the Gas Lift(5), then push the Seat Cushion(2) down onto the Gas Lift firmly until the connection is secure.

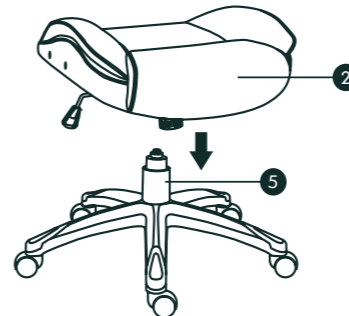

Step 4

Attach the Arms(3) to the Seat Cushion(2) with FOUR Bolts M8*25mm(11) by using the Wrench(13).

Note 1: Arms are labeled with an "L" (left) or "R" (right) to show which sides they should be placed on.

Note 2: Do not tighten all the bolts to 100%, make sure it has space to adjust in the next steps.

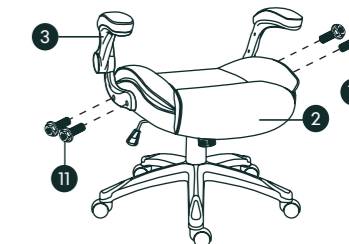
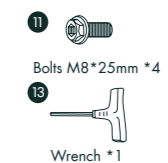

Step 5

Lay the Back Cushion on the seat of the chair with the top of the cushion toward the front. Attach the Back Cushion(1) to the Arms by inserting TWO Bolts M8*25mm(11) in the LOWER holes with the Wrench(13).

Note: Arms are labeled with an "L" (left) or "R" (right) to show which sides they should be placed on.

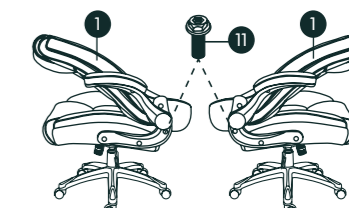

Step 6

Rotate the back of the chair up, then secure it with the TOP TWO Bolts M8*25mm(11) with the Wrench(13). Adjust the balance on each side of the chair, and fully tighten all the bolts at this step.

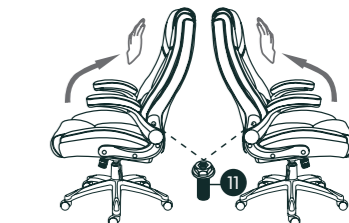

Step 7

Press the Plastic Caps(12) into the Arms holes to cover the bolts.

