

# INSTALLATION INSTRUCTION

## Mini In-Ground

1011/ 1021/ 1031/ 1041/ 1051/ 1061/ 2011/ 2012/ 2021/ 2022/ 2031  
2041/ 2051/ 2052/ 2061/ 2071/ 2081/ 2091/ 2101/ 2111/ 2121/ 2131

WAC  
LANDSCAPE LIGHTING

### SAFETY INSTRUCTION

IMPORTANT: NEVER attempt any work without shutting off the electricity.

- Read all instructions before installing.
- System is intended for installation by a qualified electrician in accordance with the National Electrical Code and local regulations.
- Place the wall switch in the "OFF" position.
- Go to the main fuse box, or circuit breaker. Unscrew the fuse(s) or switch "OFF" the circuit breaker switch(es) that control the power to the space that you are working on.

### CAUTION:

All parts must be used as indicated in these instructions. Do not substitute any parts, leave parts out, or use any parts that are worn out or broken. Failure to follow this instruction could invalidate the ETL/cETL listing of this fixture.

### AVERTISSEMENT

#### IMPORTANT : COUPEZ L'ÉLECTRICITÉ AVANT TOUTE MANIPULATION.

- Lisez toutes les instructions avant d'installer.
- Système est destiné à être installé par un électricien qualifié en conformité avec le code national de l'électricité et les règlements locaux.
- Placez l'interrupteur mural en position d'arrêt (« OFF »).
- Accédez au panneau central de disjoncteurs ou de fusibles de votre demeure et placez l'interrupteur principal en position d'arrêt (« OFF »).

### MISE EN GARDE

Toutes les pièces doivent être utilisées tel qu'il est indiqué dans ces instructions. Ne remplacez pas les pièces, n'en laissez pas de côté et ne les utilisez pas si elles sont usées ou brisées. Le non-respect de ces instructions peut annuler l'homologation ETL/cETL du luminaire.

### THIS INSTRUCTIONS APPLY TO THE MODELS BELOW:

*\*Note: Transformer is required to power the fixture. (sold separately)*



1011



1021



1031



1041



1051



1061



2011

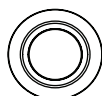

2021/2031

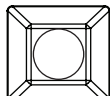

2051



2041



2061



2071

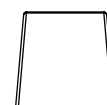

2081



2091

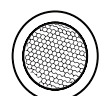

2012

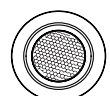

2022

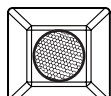

2052



2101



2111

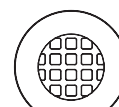

2121



2131

Fixture Accessory (included in box)



Outdoor Rated Wire Nut  
Model: **9020-WNT-BK**  
Qty: 2pcs

waclighting.com  
Phone (800) 526.2588  
Fax (800) 526.2585

Headquarters/Eastern Distribution Center  
44 Harbor Park Drive  
Port Washington, NY 11050

Central Distribution Center  
1600 Distribution Ct  
Lithia Springs, GA 30122

Western Distribution Center  
1750 Archibald Avenue  
Ontario, CA 91761

# INSTALLATION INSTRUCTION

## Mini In-Ground

1011/ 1021/ 1031/ 1041/ 1051/ 1061/ 2011/ 2012/ 2021/ 2022/ 2031  
2041/ 2051/ 2052/ 2061/ 2071/ 2081/ 2091/ 2101/ 2111/ 2121/ 2131

WAC  
LANDSCAPE LIGHTING

### SOFTSCAPE INSTALLATION

*\*Note: Transformer is required to power the fixture. (sold separately)*

1. Turn the main power off.
2. Dig a hole at the point of application. Make sure the hole measures roughly  $\text{ØA}^*$  in diameter and 4 inches in depth. (**Fig.1**)
3. Place a layer of pea gravel at the base of the hole to help with drainage.
4. Connect the fixture wires to landscape wires coming from the transformer using the outdoor rated direct burial wire nuts provided
5. Place the fixture in the hole and repack the soil to hold it in place. Make sure the trim is flush with the ground.

**Fig.1**

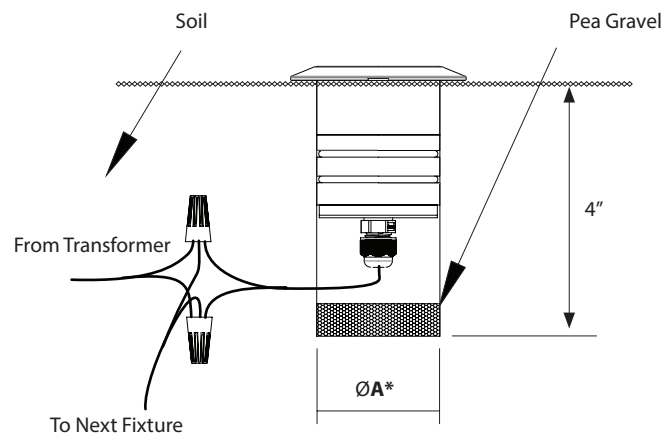

For model # 1011/1021/1031/1041/1051/1061:  $\text{A}^* = \text{Ø}1 \text{ in.}$

For model # 2011/2012/2021/2022/2041/2051/  
2052/2061/2071/2081/2091/2101/  
2111/2121/2131:  $\text{A}^* = \text{Ø}2 \text{ in.}$

### HARDSCAPE INSTALLATION

*\*Note: Transformer is required to power the fixture. (sold separately)*

1. Turn the main power off.
2. Prepare a hole large enough ( $\text{B}^*$  diameter) to fit a schedule 80 pipe (not included). (**Fig.2**)
3. Install the pipe into the hole
4. Connect the fixture wires to low voltage wires coming from the transformer using the outdoor rated direct burial wire nuts provided.
5. Smear some plumbers' silicone (not included) on the O-rings of the fixtures to help keep moisture out.
6. Insert the fixture into the pipe, making sure the trim is flush with the mounting surface.

**Fig.2**

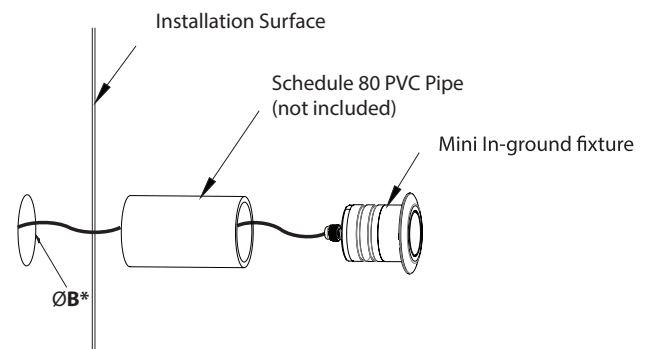

For model # 1021/1031/1041/1051/1061:  $\text{B}^* = \text{Ø}1.315 \text{ in.}$

For model # 2021/2022/2041/2051/ 2052/  
2061/2071/2081/2091/2101/  
2111/2121/2131:  $\text{B}^* = \text{Ø}2.375 \text{ in.}$

waclighting.com  
Phone (800) 526.2588  
Fax (800) 526.2585

Headquarters/Eastern Distribution Center  
44 Harbor Park Drive  
Port Washington, NY 11050

Central Distribution Center  
1600 Distribution Ct  
Lithia Springs, GA 30122

Western Distribution Center  
1750 Archibald Avenue  
Ontario, CA 91761

# INSTALLATION INSTRUCTION

## Mini In-Ground

1011/ 1021/ 1031/ 1041/ 1051/ 1061/ 2011/ 2012/ 2021/ 2022/ 2031  
2041/ 2051/ 2052/ 2061/ 2071/ 2081/ 2091/ 2101/ 2111/ 2121/ 2131

WAC  
LANDSCAPE LIGHTING

### OUTDOOR WALL INSTALLATION

*\*Note: Transformer is required to power the fixture. (sold separately)  
UL listed for outdoor use only*

1. Turn the main power off.
2. Attach the spring clip using the provided clip screws.
3. Cut a hole at the installation location. (**Fig.3**)
4. Connect the fixture wires to low voltage wires coming from the transformer using the outdoor rated direct burial wire nuts provided.
5. Smear some plumbers' silicone (not included) on the O-rings of the fixtures to help keep moisture out.
6. Insert the fixture into the hole, making sure the trim is flush with the mounting surface

**Fig.3**

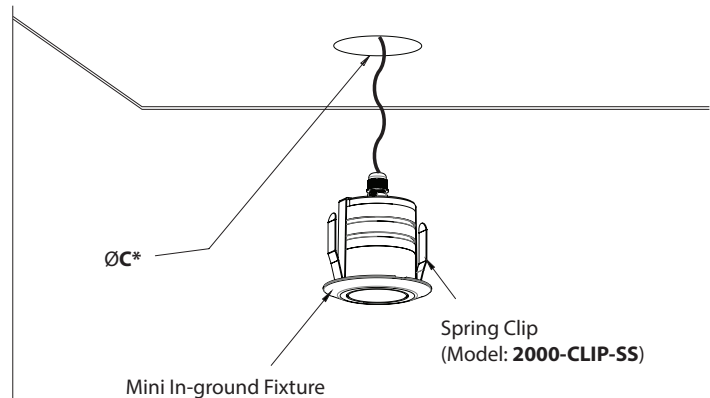

For model # 1021/1031/1041/1051/1061: C\* = Ø1.375 in.

For model # 2021/2022/2041/2051/2052  
2061/2071/2091/2101/2111/  
2121/2131: C\* = Ø2.25 in.

### FOUNTAIN INSTALLATION

*\*Note: Transformer is required to power the fixture. (sold separately)*

1. Turn the main power off.
2. Mount the fixture onto the assembled fountain canopy using the provided screws.
3. Checking the required drill size for your flush mount plastic anchors for No. 6 screws, use a hammer drill with a masonry bit to drill out two holes at the screw locations. The depth of the hole should be slightly longer than the length of the plastic anchor.
4. Place the flush mount plastic anchor (not included) in the hole, using the back of a screwdriver to gently hammer it in.
5. Replace the fixture and rotate the fountain canopy until it is in the desired position. Make sure to line up the slots with the anchors.
6. Screw the No. 6 screws into the plastic anchors, securing the fixture.
7. Connect the fixtures wires to landscape wires connected to your transformer using the provided outdoor rated wire nuts.
8. Loosen the thumbscrew and rotate the fixture so that it is facing the desired direction. Refasten the thumbscrew to secure.

**Fig.4**

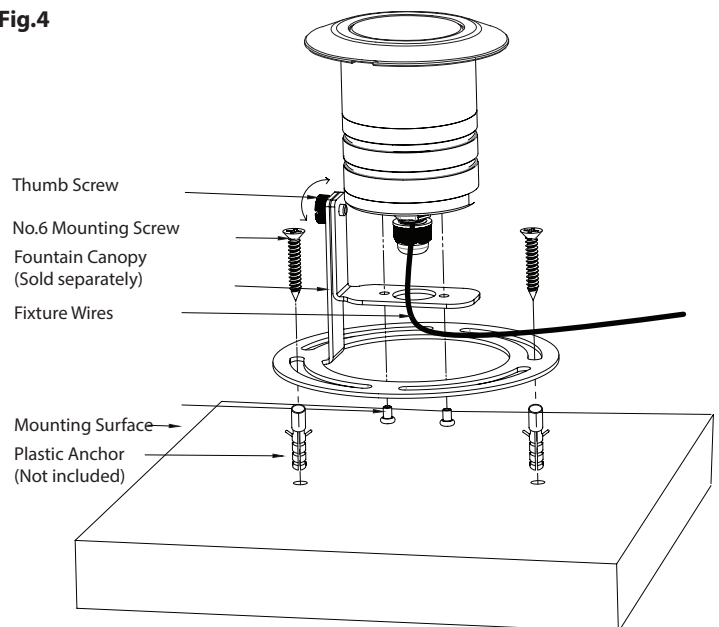

*Note: Only for model # 2031*

wacighting.com  
Phone (800) 526.2588  
Fax (800) 526.2585

Headquarters/Eastern Distribution Center  
44 Harbor Park Drive  
Port Washington, NY 11050

Central Distribution Center  
1600 Distribution Ct  
Lithia Springs, GA 30122

Western Distribution Center  
1750 Archibald Avenue  
Ontario, CA 91761

# INSTALLATION INSTRUCTION

## Mini In-Ground

1011/ 1021/ 1031/ 1041/ 1051/ 1061/ 2011/ 2012/ 2021/ 2022/ 2031  
2041/ 2051/ 2052/ 2061/ 2071/ 2081/ 2091/ 2101/ 2111/ 2121/ 2131

WAC  
LANDSCAPE LIGHTING

### CONCRETE POUR INSTALLATION

*\*Note: Transformer is required to power the fixture. (sold separately)*

1. Turn the main power off.
2. Install wiring and conduit (use 1/2" NPT) at desired position, plug all un-used holes. Refer to applicable wiring diagram. **(Fig.5)**
3. Secure 4" weatherproof junction box to the ground, preferably over a layer of sand or pea gravel for drainage.
4. Cut Schedule 80 PVC Pipe in excess length for planned concrete thickness. (An 18" long pipe is supplied with concrete pour kit)  
*\*Make sure the cut end is put into the concrete pour kit*
5. Insert the PVC pipe into the mounting flange and lock it with screws
6. Secure concrete pour kit onto the 4" junction box.
7. Pour desired amount of concrete, making sure **NO CONCRETE ENTERS THE BOX. (Fig.6)**
8. After the concrete has cured, cut off excess PVC pipe protruding from the ground. **(Fig.7)**
9. Connect fixture wires to box wires using the outdoor rated direct burial wire nuts. **(Fig.8)**
10. Smear plumbers' silicone (not included) to O-rings.
11. Insert LED Fixture into flange with a twisting motion. Make sure the trim is flush with the top of the poured concrete.
12. To remove fixture, use a small flat head screwdriver and pry it from the flange. **(Fig.9)**

**Fig.5**

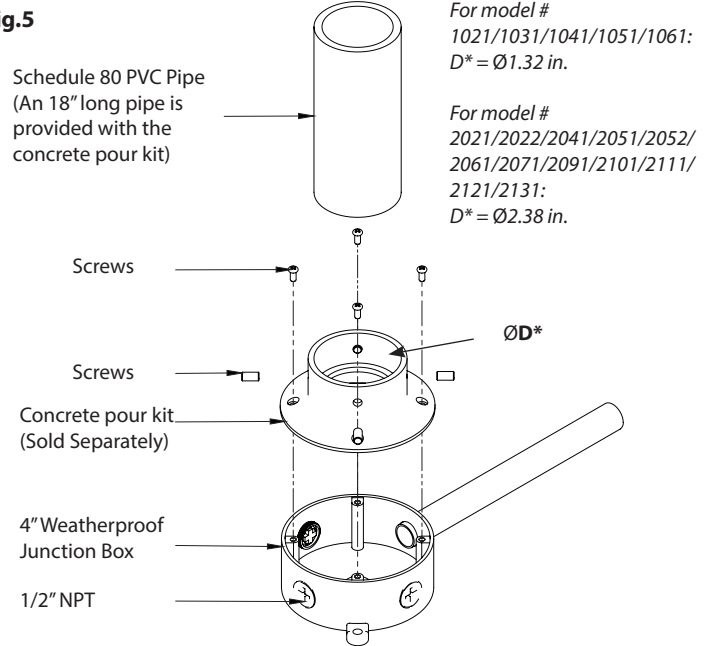

**Fig.6**

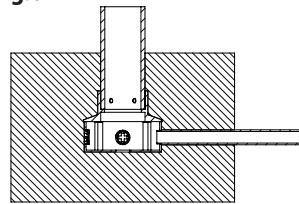

**Fig.7**

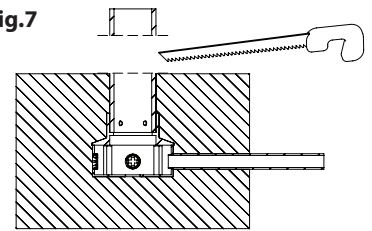

**Fig.8**

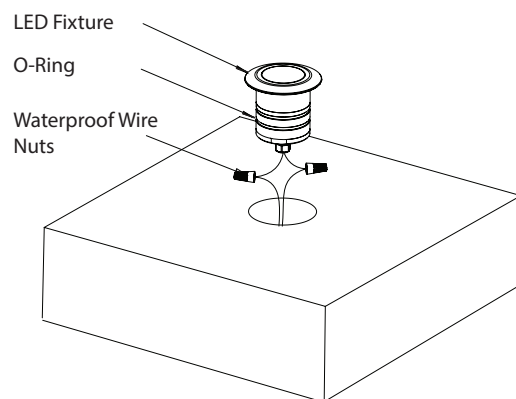

**Fig.9**

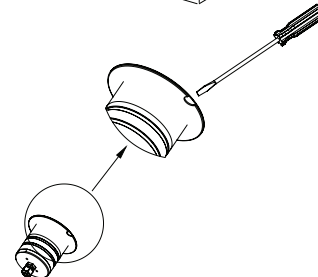

waclighting.com  
Phone (800) 526.2588  
Fax (800) 526.2585

Headquarters/Eastern Distribution Center  
44 Harbor Park Drive  
Port Washington, NY 11050

Central Distribution Center  
1600 Distribution Ct  
Lithia Springs, GA 30122

Western Distribution Center  
1750 Archibald Avenue  
Ontario, CA 91761