

# INSTRUCTION SHEET

## THE GUEST ROOM BED 5/0

---

Thank you for purchasing this quality product. Be sure to check all packing material carefully for small parts that may have come loose inside the carton during shipment.

**Caution:** (1) These parts are cumbersome and heavy. This product can best be assembled with the assistance of one or more persons in order to prevent personal injury and to insure parts are not damaged during the assembly process. If dirty, clean finished parts with mild dishwashing liquid and water solution applied on damp cloth. Cloth should not be excessively wet. Polish finish with soft cloth and an industry recognized furniture polish.

(2) To prevent damage to your floor or carpet, please check the bottom of each piece of furniture for stain residue and rough surfaces and also check for staples or nails left after removing the packaging material. The manufacturer will not be held responsible if preventative steps are not taken prior to installation.

(3) Unpack and dispose of all packing material but be careful not to throw away any assembly parts or hardware. Read the instruction sheet and parts list carefully. Remove all staples and screws used for packaging carefully using pliers and or screwdrivers to prevent injury and scratching or damaging flooring.

(4) During normal use everyday, screws, bolts, nuts and wooden plugs may loosen up. They should be periodically inspected and re-tightened to prevent damage to the furniture and (or) personal property or cause injury. Always check to be sure all hardware on this list and the above mentioned components is attached to the furniture properly and kept tightened at all times.

### **PARTS LIST:**

#	Description	Qty.	#	Description	Qty.
<b>A</b>	Headboard	1 pc	<b>E</b>	Cross Bar	3 pcs
<b>B</b>	Footboard	1 pc	<b>F</b>	Support leg	6 pcs
<b>C</b>	Left Side Rail	2 pcs	<b>G</b>	Hardware Pack	1 bag
<b>D</b>	Right Side Rail	2 pcs			

**Assembly Procedure:** (Please follow the sketches below.)

**Step 1:** Unpack, inspect, and read assembly instruction carefully. Lay out the parts and hardware. Make sure the quantity of each is correct.

**Step 2:** Attach adjustable levelers (10) to support legs (F). And then attach the support legs (F) to the cross bars (E) with short bolts (1).

**Step 3:** Attach the left side rails (C) and right side rails (D) to the headboard (A) and footboard (B) with long bolts (2), lock washers (4) and flat washers (5), please don't tighten the bolts for this step.

**Step 4:** Attach the left side rails (C) and right side rails (D) to the cross bars (E) with the flat head countersink bolts (9) and nuts (3), please don't tighten the bolts for this step.

Please tighten all the bolts.











**Step 5:** Please adjust the levelers (10) under the support legs (F) if necessary before laying down the mattress.

**Assembly is now complete.**

# INSTRUCTION SHEET

## THE GUEST ROOM BED 5/0

### Hardware Pack (G)

1	Short Flat Head Bolt		1/4*5/8"	12PCS
2	Long Flat Head Bolt		5/16*1"	8PCS
3	Nut		1/4	12PCS
4	Lock washer		5/16	8PCS
5	Flat washer			8PCS
6	Allen Wrench		5/16	1PC
7	Allen Wrench		1/4	1PC
8	Open Wrench		1/4	1PC
9	Flat Head Countersink Bolt		1/4*3/4"	12PCS
10	Adjustable leveler		1/4*1-3/8"	6PCS

## Step2

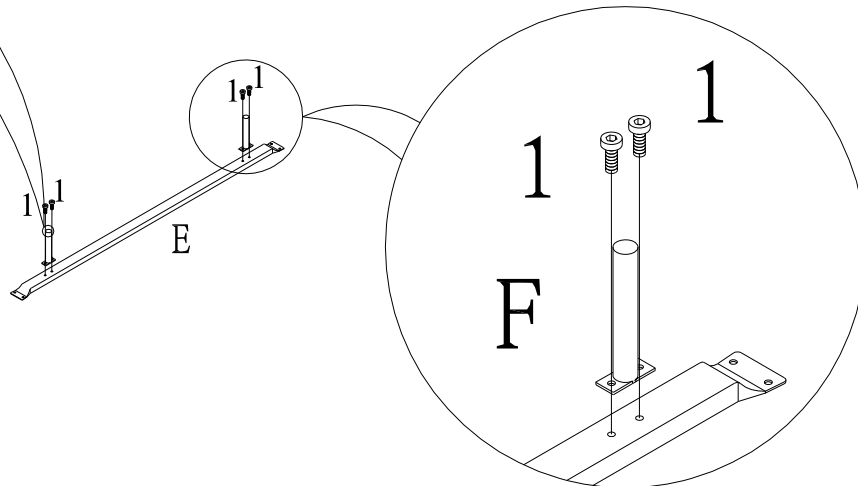
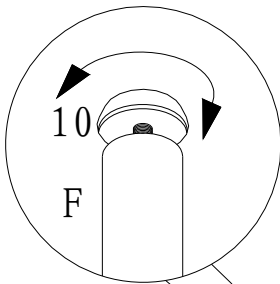

## Step3

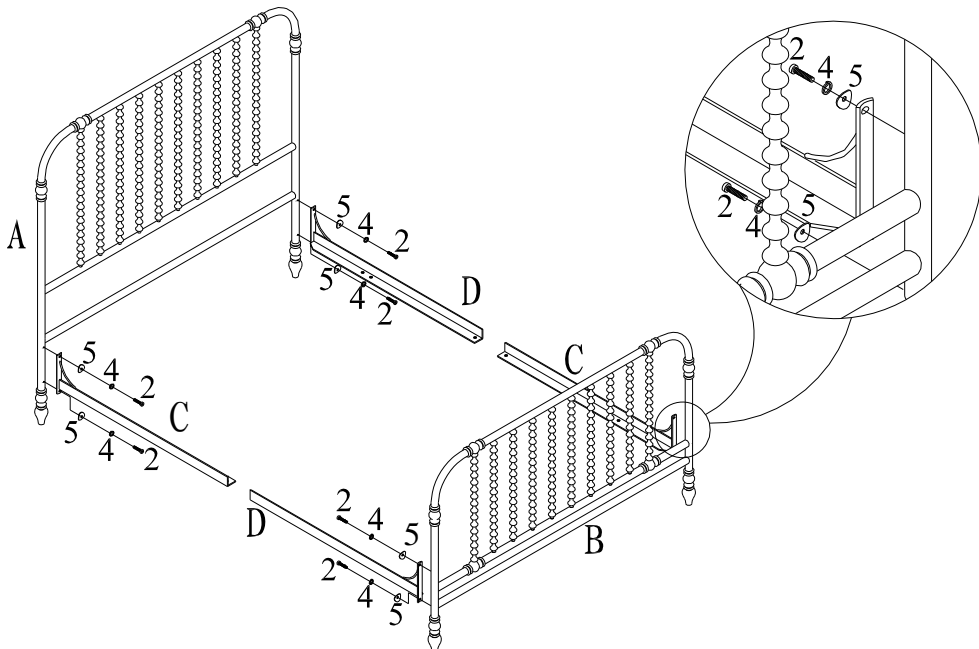

# INSTRUCTION SHEET

## THE GUEST ROOM BED 5/0

### Step4

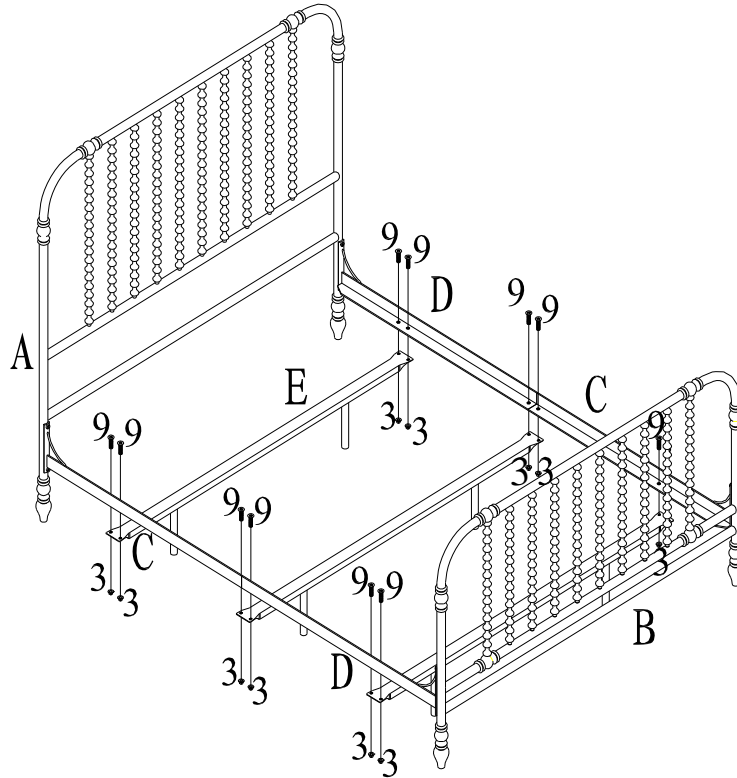

### Step5

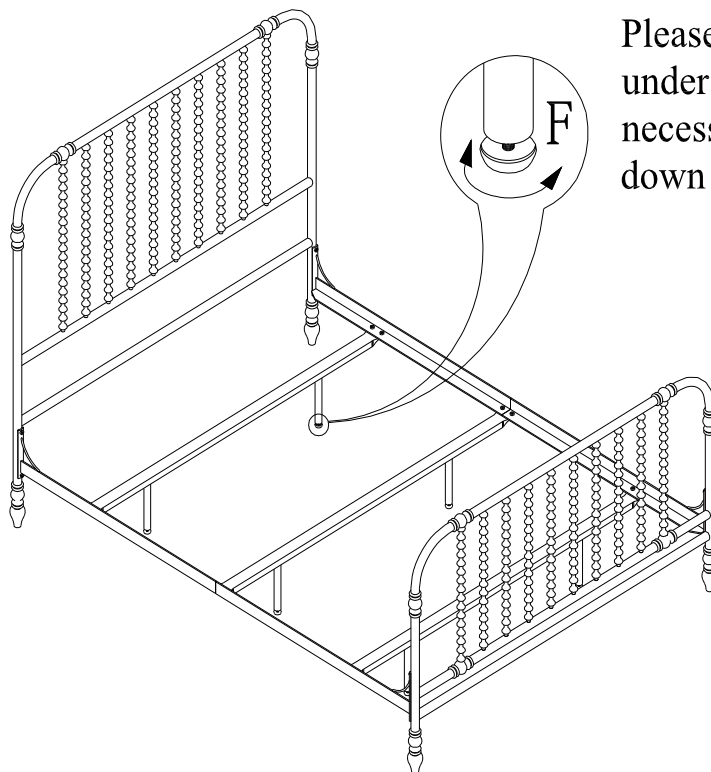

Please adjust the levelers under the cross bar legs if necessary before laying down the mattress.