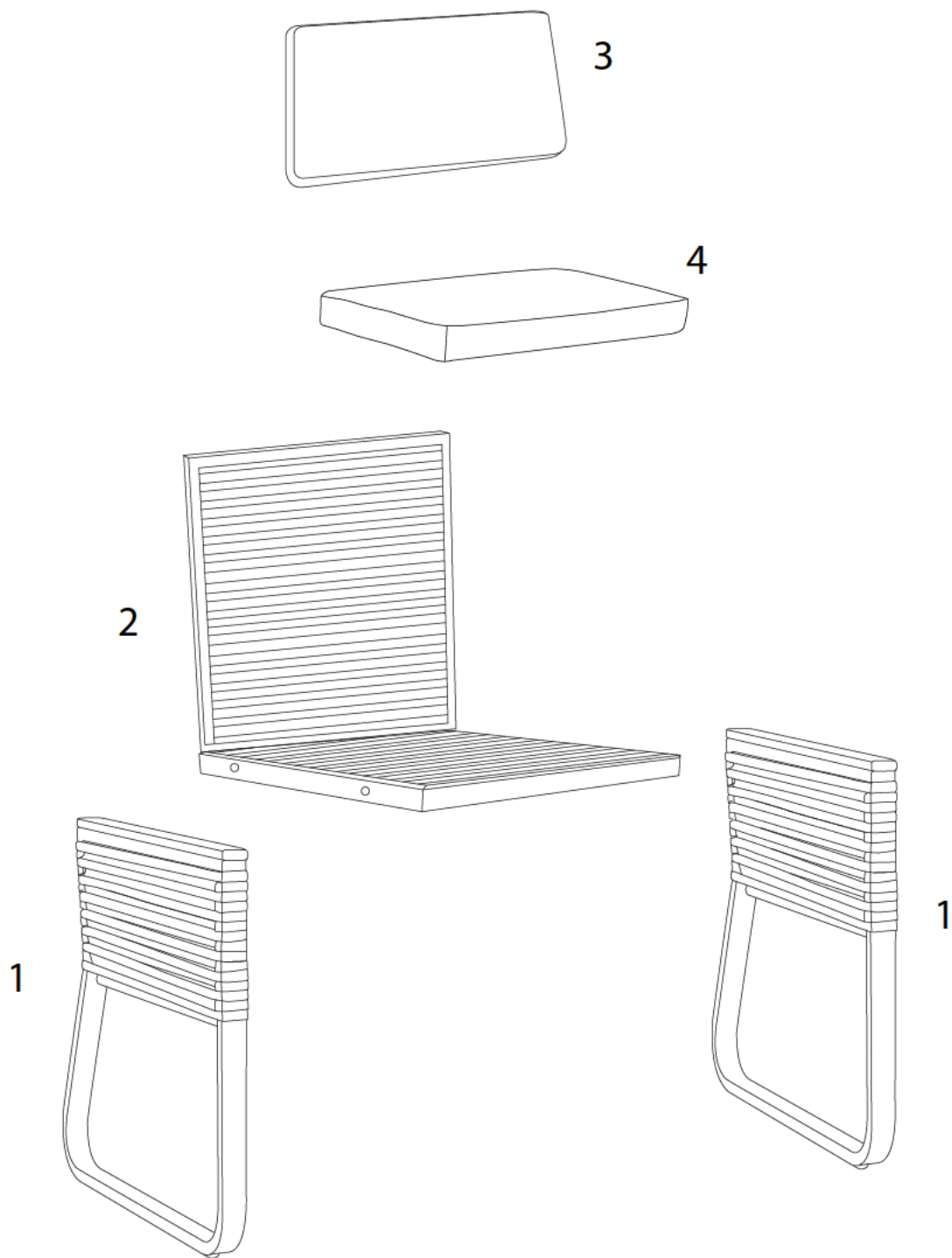

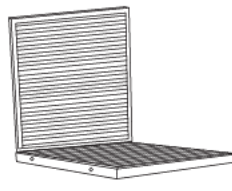



Diagram illustrating assembly instructions and safety warnings:

- Warning 1:** A warning triangle with an exclamation mark is positioned above a box containing an L-shaped corner bracket and a crossed-out power drill, indicating that a power drill should not be used for this step.
- Warning 2:** A second warning triangle with an exclamation mark is positioned above a box containing a rectangular block being placed on a textured surface and a crossed-out block being placed on a smooth surface, indicating that the block should be placed on the textured surface.
- Time:** A clock icon is shown next to the text "40'", indicating an estimated assembly time of 40 minutes.
- Person:** A stick figure icon is shown next to the number "1", indicating that one person is required for assembly.



1	2	3	4
			
x 2	x 1	x 1	x 1

A

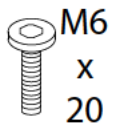

x 2

B

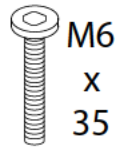

x 4

C

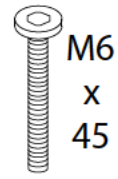

x 2

D

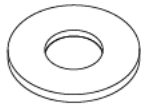

x 8

E

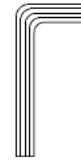

x 1

1

1



x 2

2



x 1

B

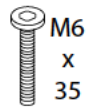

x 4

D

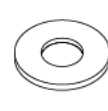

x 4

E

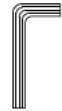

x 1

2

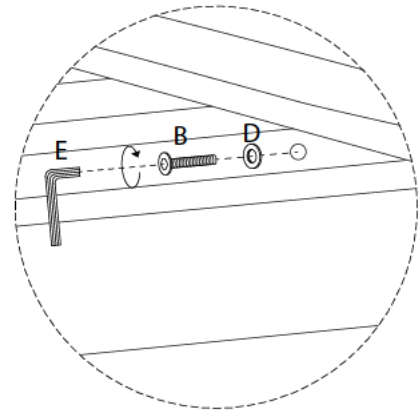
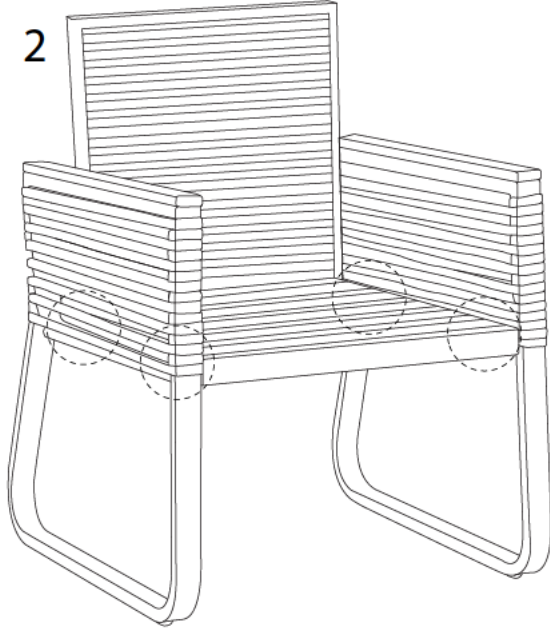

2

A

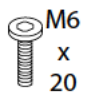

x 2

D

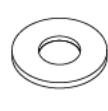

x 2

E

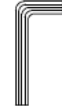

x 1

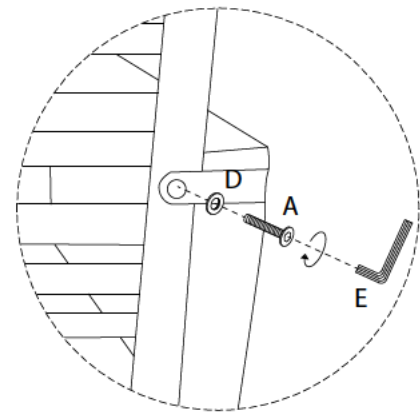
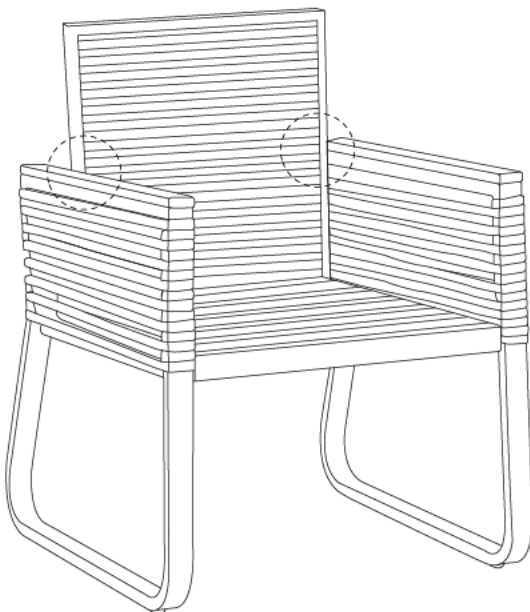

3

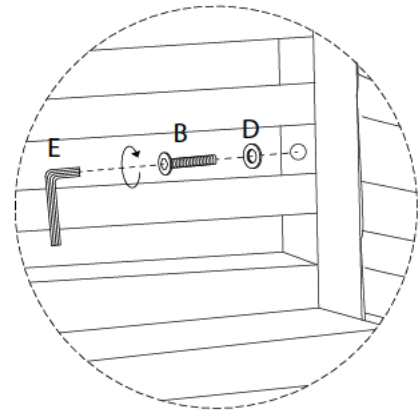
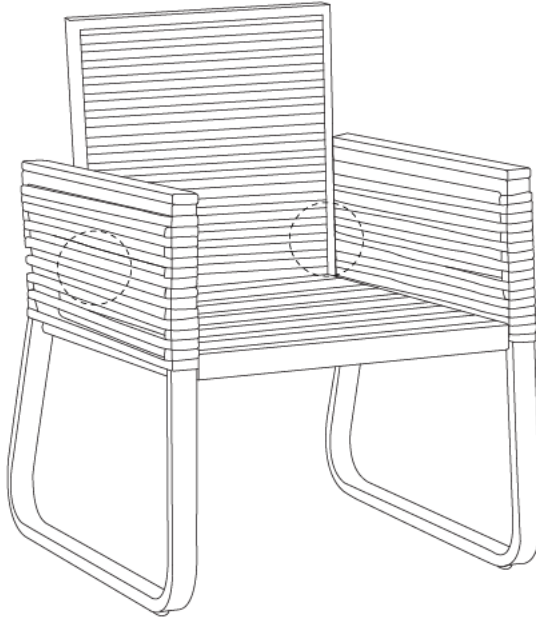
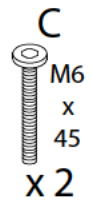

4

