

# Assembly Instructions

Caution :You must read this before you proceed

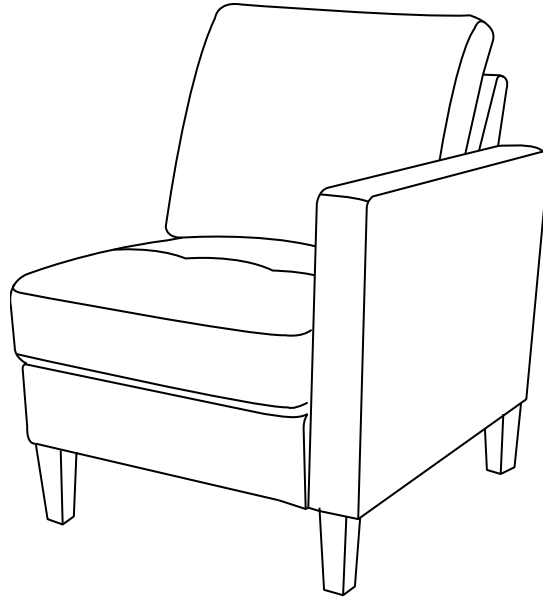



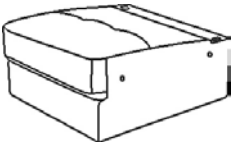
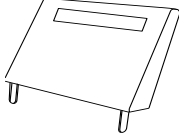
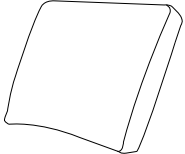
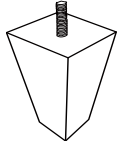
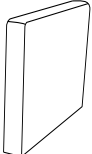

## Right Arm Sofa



### Parts List

Label	Picture	Description	QTY
A		Chair Seat	1
B		Backrest	1
C		Back Cushion	1
D		Leg	4
E		Right Arm	1

# Hardware

Label	Picture	Description	QTY
①		Washer Rings	7
②		Allen key	1
③		Bolt M8*50mm	3
④		Bolt M8*20mm	2
⑤		Spring Washer	4
⑥		Flat Washer	4
⑦		Connecting Piece	1

## Assembly Preparation

Before Beginning Assembly:

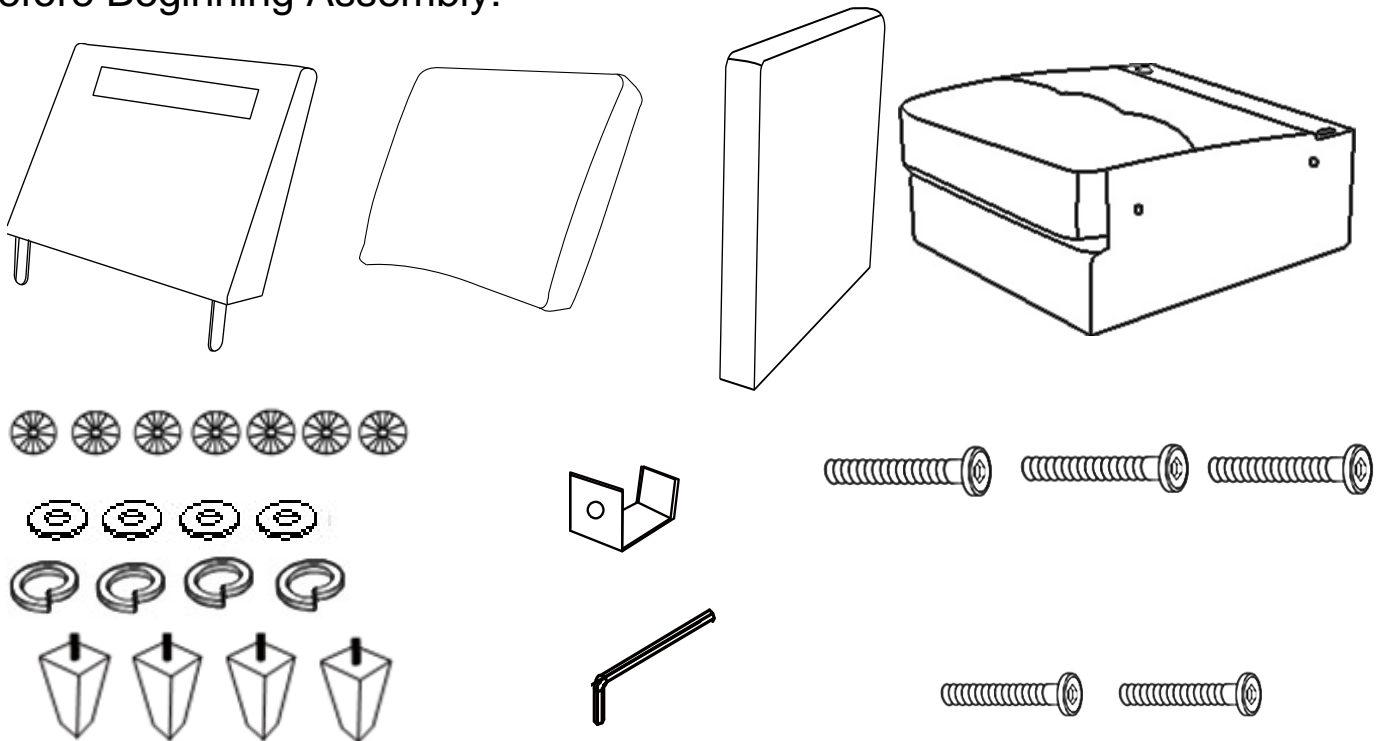

- Read instructions, cover to cover-



- Have 2 adults on hand for assembly-



- Do not assemble on flooring or carpet-



- Assemble on a clean non-marring surface (packing foam)-



- Save all packaging until finished-

# Assembly Steps

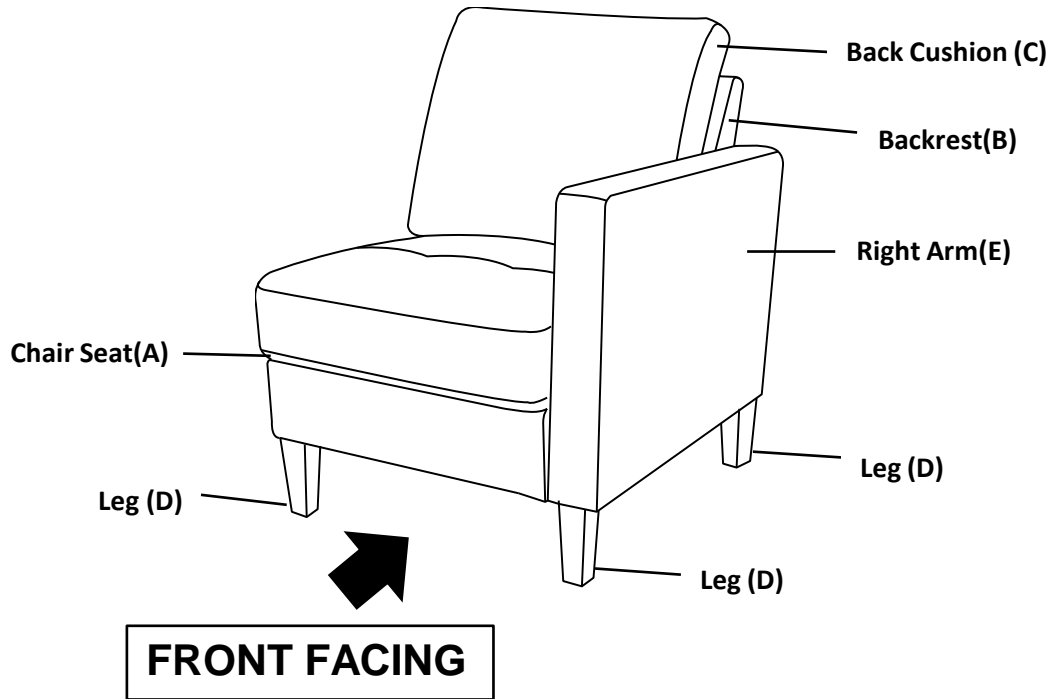

This Arm Sofa has multiple parts and may require up to some 30 minutes to assemble. To give you an overview of the Arm Sofa parts, the above picture is to help you put the various parts into perspective. Please read through the instructions below to familiarise yourself with the parts and steps before assembly.

## Step 1

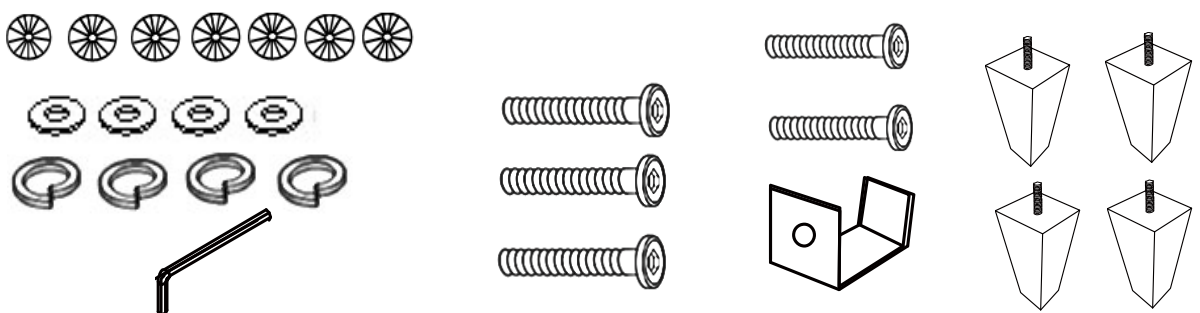
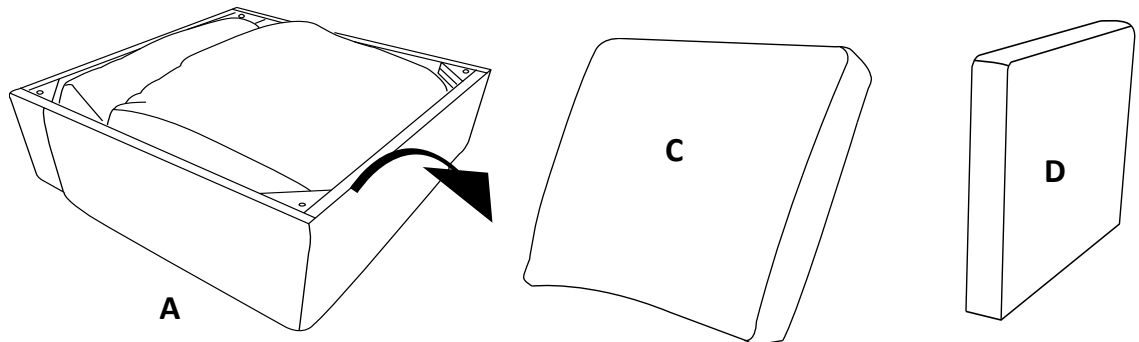

Position the arm sofa on its back, as shown.  
Unzip to open pouch and remove the 4 wooden legs and Back Cushion , close the pouch.

## Step 2

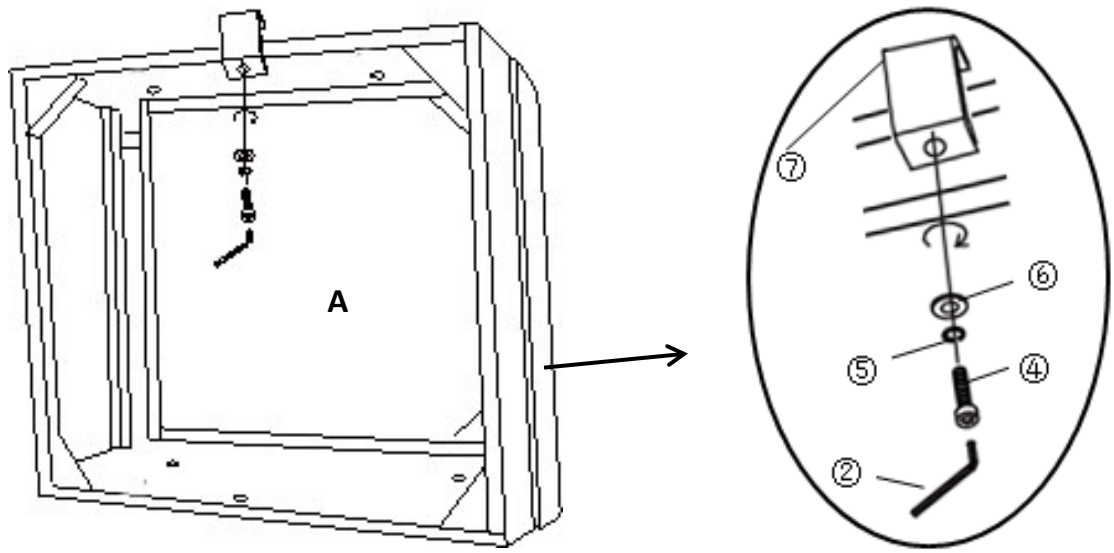

Stand the Chair Seat(A) up as show in the left Picture.  
Attach the Connecting Piece(⑦) to Chair Seat(A) using Bolts(④), Spring Washers(⑤), and Flat Washer (⑥) with Allen Key(②) as shown in the right picture.

## Step 3

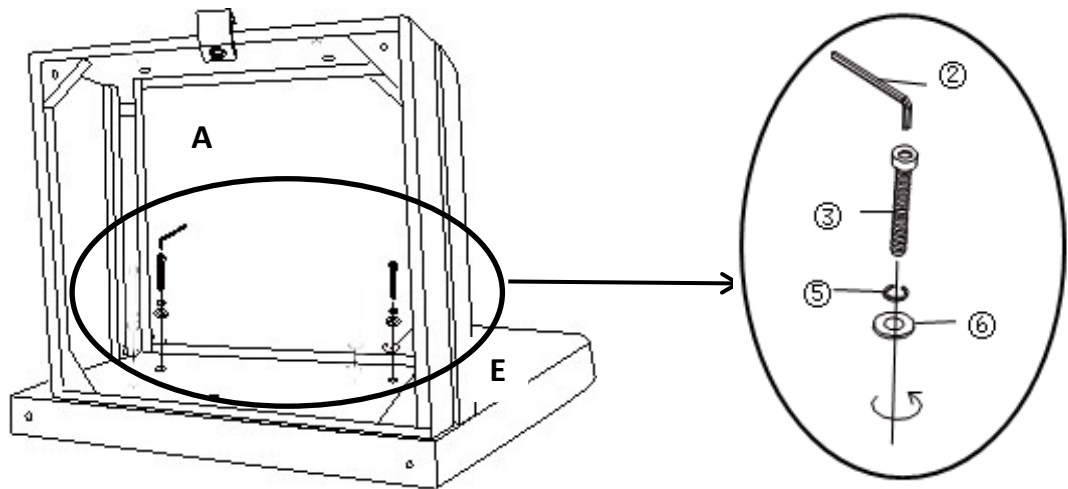

Attach the Right Arm (E) to Chair Seat(A) on the other side by using Bolts(③), Spring Washers(⑤), and Flat Washer (⑥) with Allen Key(②) as shown in the picture.

## Step 4

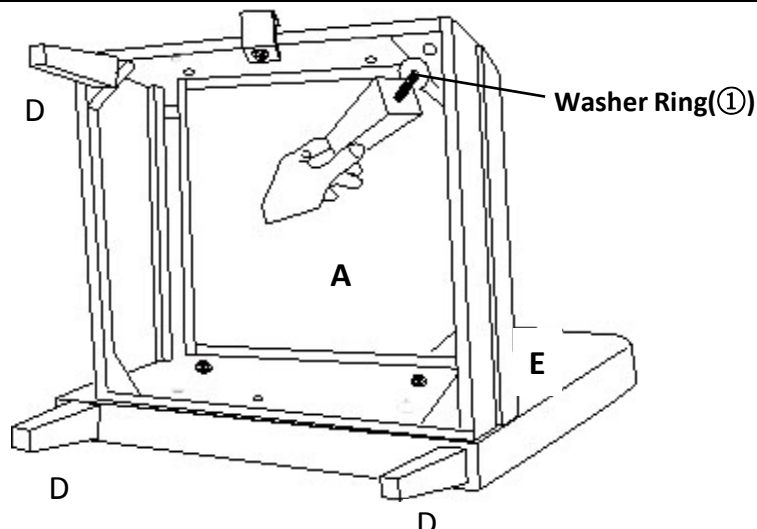

Install the Legs(D) into the bottom of the Seat(A) by placing a Washer Ring(①) onto the threaded stem of the Legs.  
And then insert the threaded stem into the threaded mounting position at each Corner of the Bottom of the Seat(A).  
Tighten by turning the Legs clockwise.  
Note: The use of Washer Rings(①) are OPTIONAL and are especially useful to help alleviate slight wobbles. Some Legs may need more than one Washer Ring whilst some Legs may not need any.  
Position arm sofa right side up and test for stability on a Level Surface.  
Add or remove Washer Rings(①) where needed to achieve stability.

### Step 5

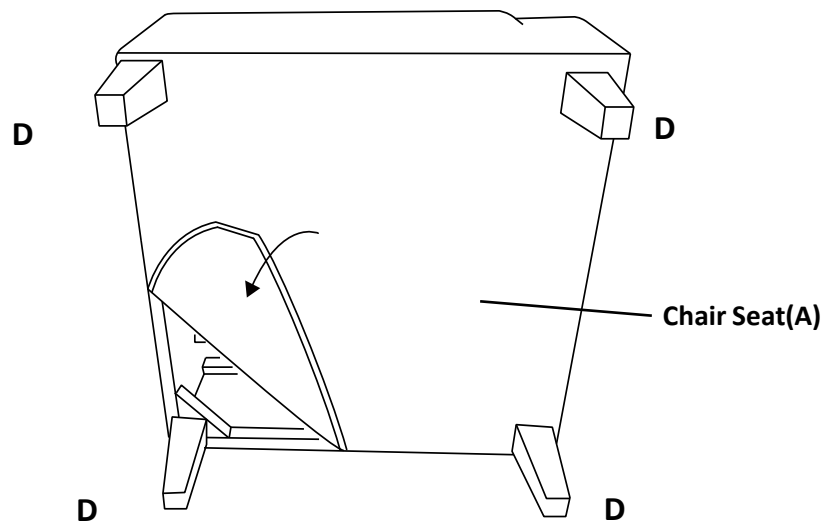

Cover the bottom of the Chair Seat(A) with the non-woven fabric.  
Smooth down the Magic Tape on all four sides of the Seat by hand.

### Step 6

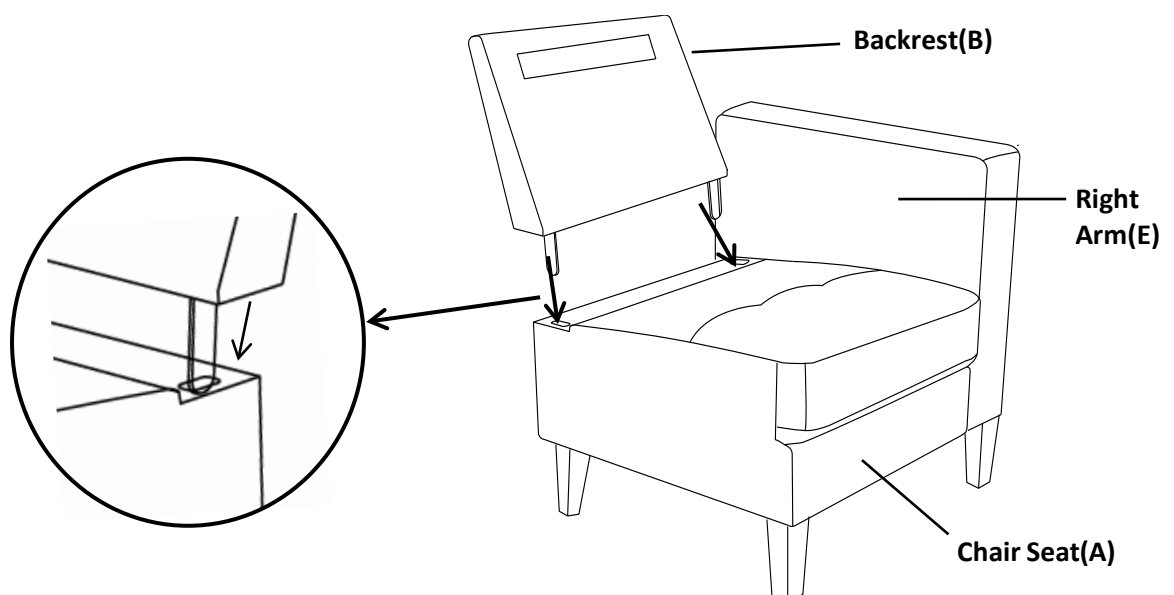

Position arm sofa right side up.  
Align the mounting positions on the Chair Seat(A) .  
Insert the Backrest (B) into the Chair Seat (A) as shown in above picture.

### Step 7

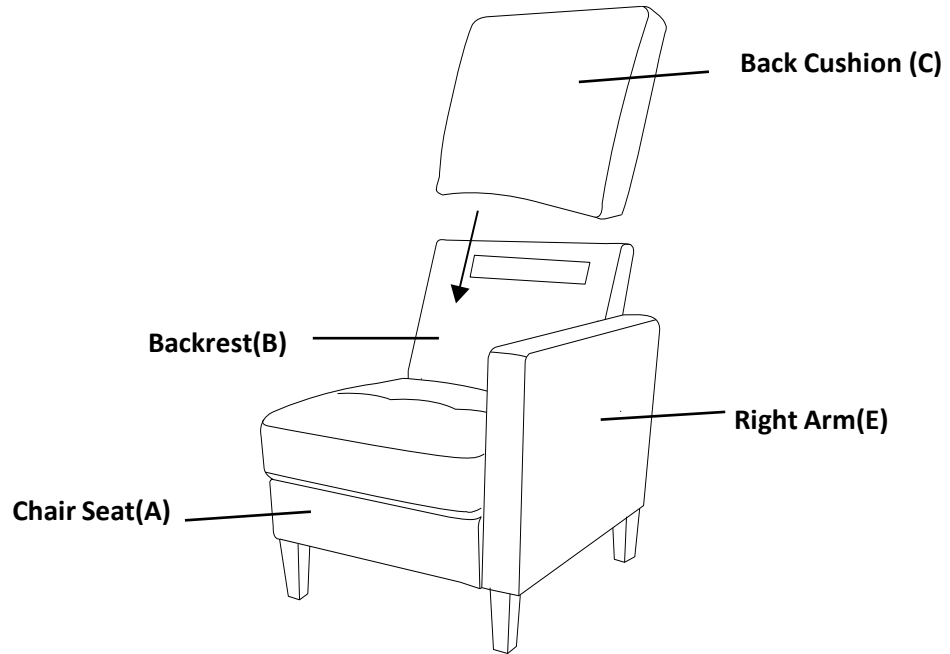

Put the Back Cushion(C) on the Right Arm Sofa.

### Step 8

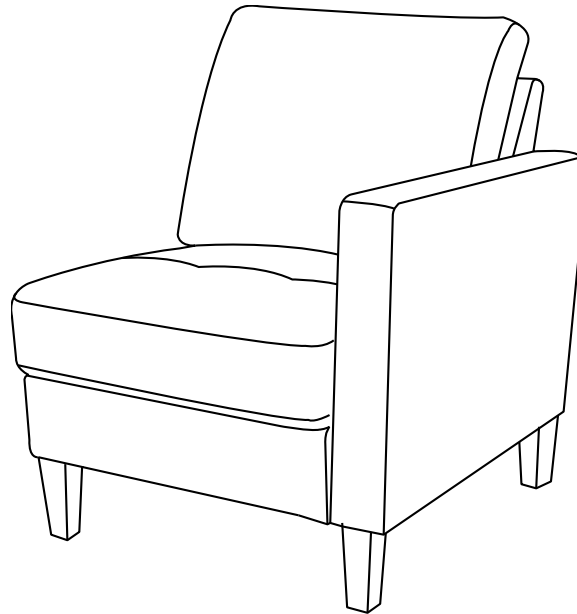

Your Right Arm Sofa is ready for use.  
Your Right Arm Sofa can only be used on a flat, level surface.

**If you already purchased 2 or more than 2 products, Please read on**

## Step 1

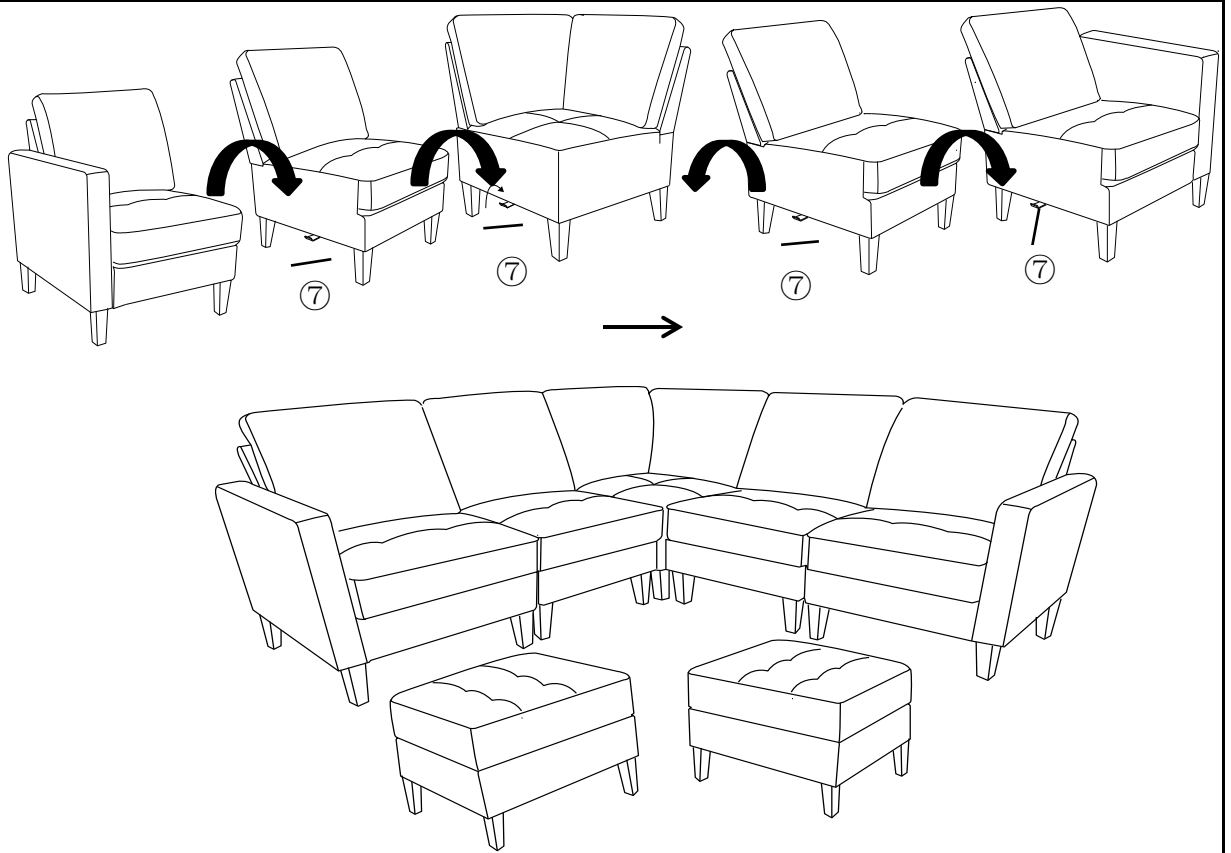

Connecting the two sofas by using the pre-fixed Connecting Piece (7) as shown in the picture.

## Step 2

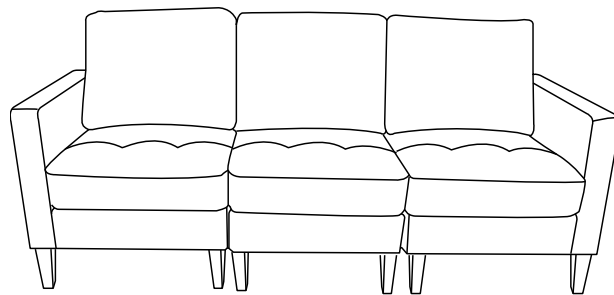

Step 2.1

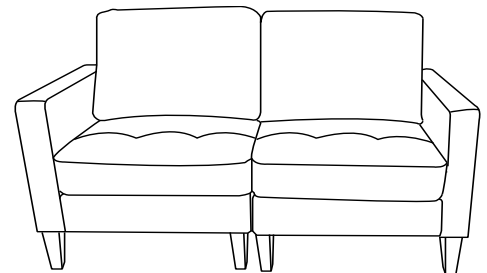

Step 2.2

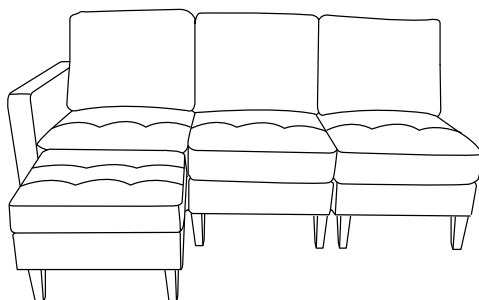



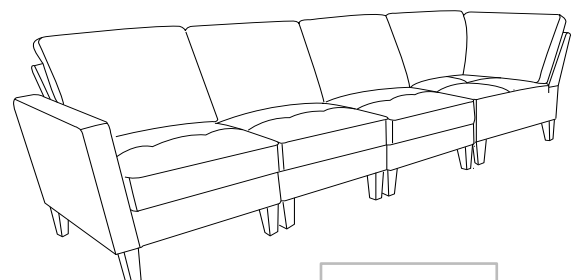

















Step 2.3



Step 2.4

Note: This is optional step in case we want to connect all sofas in a set together and to match the environment of your home.

## Care & Maintenance

-   ● Do not put hot items directly on furniture surface
  -   ● Do not clean furniture with harsh cleansers or polish.
  -   ● Do not place furniture under direct sunlight.
  -   ● Do not place furniture near heating or cooling vents.
  -   ● Do not write on furniture without a padded barrier to protect the surface.
  -   ● Do not place furniture outside . For indoor use only .
  -   ● Not for commercial use. For residential use only .
  -   ● Stains may be removed with mild soap solution and damp cloth.
  -   ● Children should not climb or jump on the furniture.
- 
-   ● Dust and pick-up spills using a clean, non-colored, lint-free cloth .

### Questions & Answers about Proposition 65

#### • What is Proposition 65?

Proposition 65 requires businesses to provide warnings to Californians about significant exposures to chemicals that cause cancer, birth defects or other reproductive harm. These chemicals can be in the products that Californians purchase, in their homes or workplaces, or that are released into the environment. By requiring that this information be provided, Proposition 65 enables Californians to make informed decisions about their exposures to these chemicals.

Proposition 65 also prohibits California businesses from knowingly discharging significant amounts of listed chemicals into sources of drinking water.

Proposition 65 requires California to publish a list of chemicals known to cause cancer, birth defects or other reproductive harm. This list, which must be updated at least once a year, has grown to include approximately 900 chemicals since it was first published in 1987.

#### • What types of chemicals are on the Proposition 65 list?

The list contains a wide range of naturally occurring and synthetic chemicals that include additives or ingredients in pesticides, common household products, food, drugs, dyes, or solvents. Listed chemicals may also be used in manufacturing and construction, or they may be byproducts of chemical processes, such as motor vehicle exhaust.

#### • What does a warning mean?

If a warning is placed on a product label or posted or distributed at a workplace, a business, or in rental housing, the business issuing the warning is aware or believes that it is exposing individuals to one or more listed chemicals.

By law, a warning must be given for listed chemicals unless the exposure is low enough to pose no significant risk of cancer or is significantly below levels observed to cause birth defects or other reproductive harm.

#### • Where can I get more information on Proposition 65?

If you have specific questions on the administration or implementation of Proposition 65, you can contact OEHHA's Proposition 65 program at [P65.Questions@oehha.ca.gov](mailto:P65.Questions@oehha.ca.gov), or by phone at (916) 445-6900.