

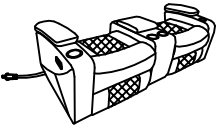

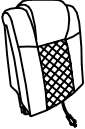

ASSEMBLY INSTRUCTION



Power Double Reclining Love Seat with Center Console

NOTE: Do not use power tools for assembly. Power tools increase the risk of over tightening which lead to splitting or cracking the wood.

COMPONENT LIST

NO.	DRAWING	QTY	DESCRIPTION
A		1PC	SEAT WITH WIRE
B		1PC	RSF BACK REST
C		1PC	LSF BACK REST
D		1PC	CONSOLE BACK REST
E		2PC	STAR KNOB BOLT

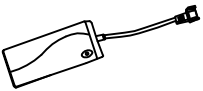
HARDWARE LIST

NO.	DRAWING	QTY	DESCRIPTION
1		1PC	ADAPTOR
2		1PC	PLUG WITH WIRE
3		1PC	Y-CABLE

Step#1

Align the female brackets at the back onto the male brackets at the seat, insert back rest to the seat then push to the end and make sure it is fixed in position securely. Assemble the console backrest to the seat and then, fasten star knob bolt through the hole behind middle of the sofa. Connecting the wire from back rest to seat for power headrest.

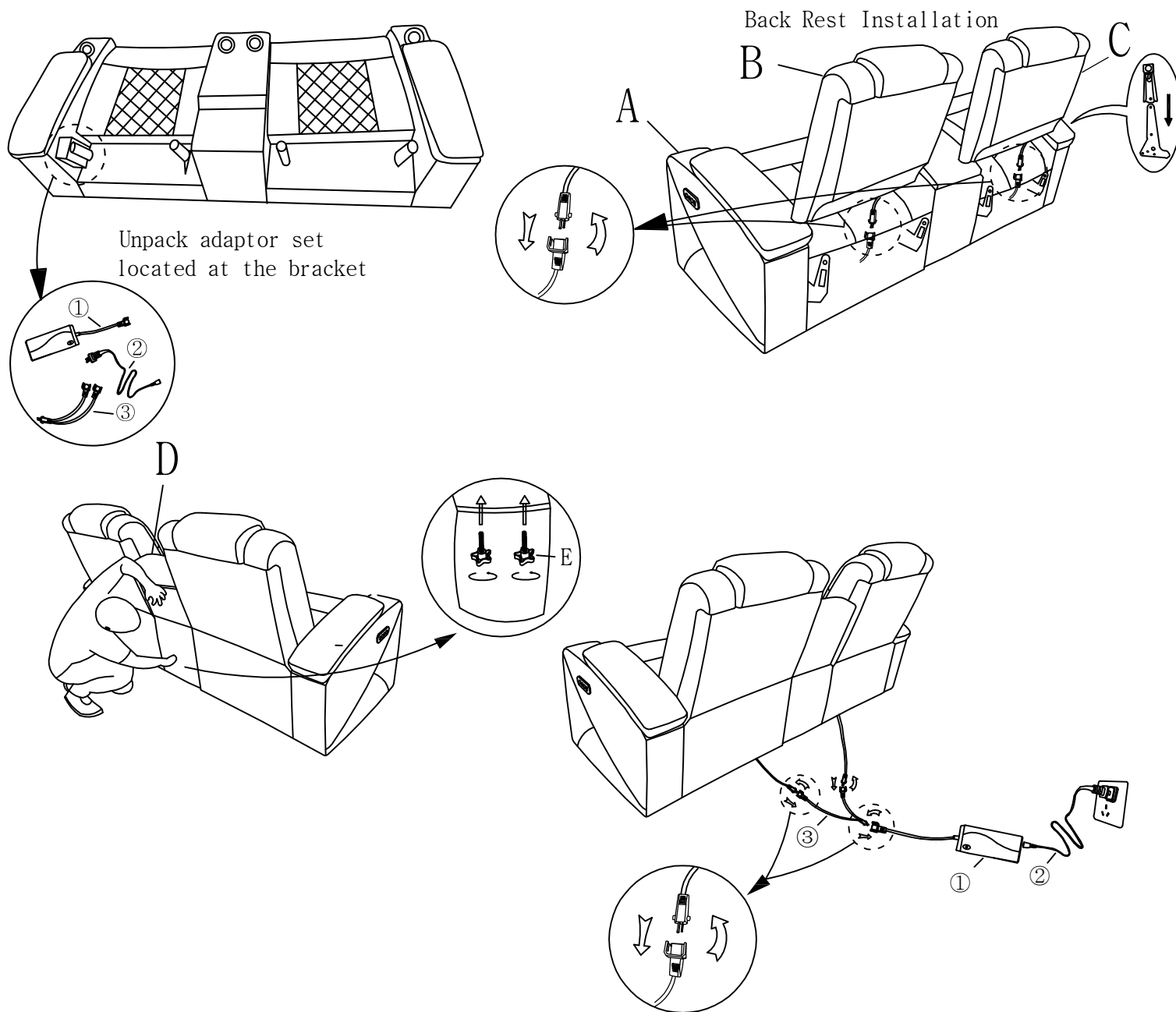

Step#2

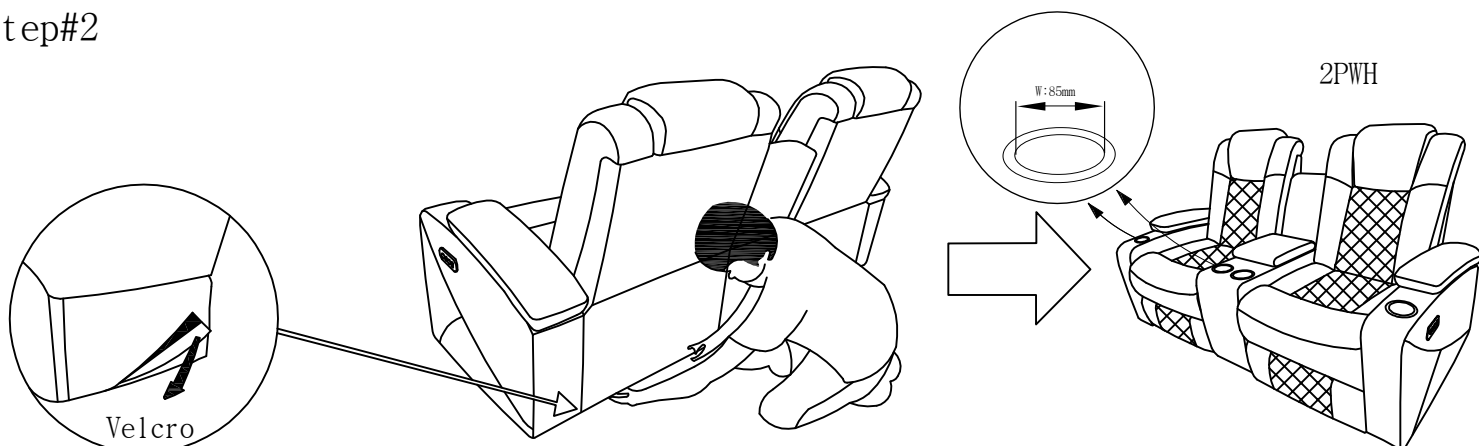

2PWH

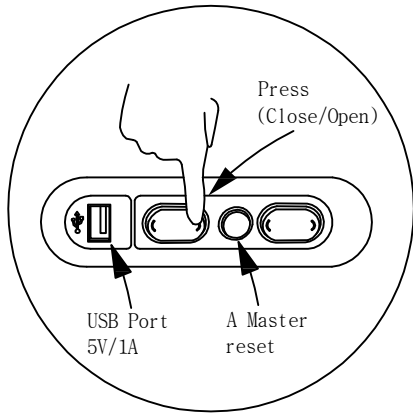

Headrest

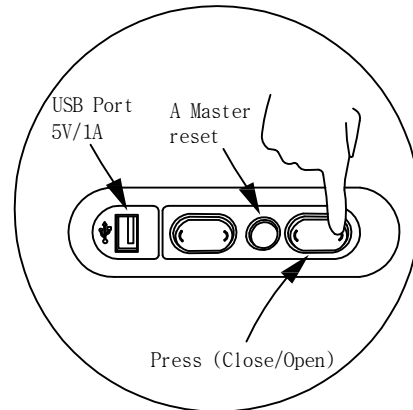

Chair

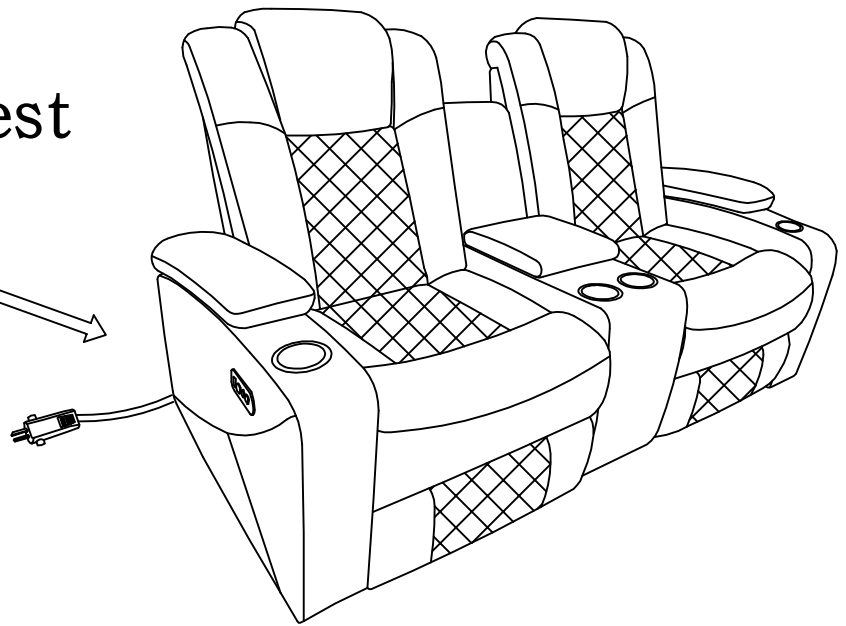

Control Switch

CARE INSTRUCTION FOR LEATHER GEL

In order to maintain the original appearance of your leather gel furniture, please follow below simple care procedure:

- Avoid exposing furniture directly to sunlight or heating and air conditioning outlets. Exposure to sunlight or heating and air conditioning outlets will fade/damage leather gel.
- Wipe gently with a damp soft cloth to remove dust dirt and any grime build up.

WARNING

- Disconnect the electrical plug from the wall outlets before cleaning, moving, servicing or when not in use for an extended period of time.
- Plug directly into a wall outlet. Do not use an extension cord or adaptor.
- Check the condition of the power transformers, electrical cords, plugs and connectors monthly. Keep the power adaptor and electrical cords away from heat sources. Never operate the unit with a damaged power adaptor, electrical cord, plug or connector.
- Before moving the product, please disconnect the electrical plug from the wall outlet and secure the mechanism to prevent unexpected opening or movement. Never move the product by the mechanism, legrest, handle, or reclining back.
- Do not attempt to disassemble or service the adaptor or motor. No serviceable parts are inside.
- Do not allow electrical cord to be pinched between moving parts or between the frame and the floor. Do not place cord under carpet or in location where it could become worn.
- Unplug the power cord immediately if you detect strange odors or fumes coming from the chair.



PLEASE KEEP ASSEMBLY INSTRUCTION FOR FUTURE REFERENCE

ASSEMBLY INSTRUCTION



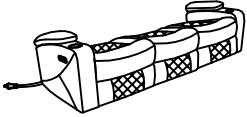

Power Double Reclining Sofa with Center Drop-Down Cup Holders

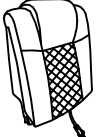
NOTE: Do not use power tools for assembly. Power tools increase the risk of over tightening which lead to splitting or cracking the wood.

COMPONENT LIST

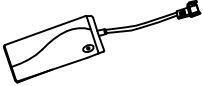
NO.	DRAWING	QTY	DESCRIPTION
A		1PC	SEAT WITH WIRE
B		1PC	LSF BACK REST
C		1PC	MIDDLE BACK REST
D		1PC	RSF BACK REST

HARDWARE LIST

NO.	DRAWING	QTY	DESCRIPTION
1		1PC	ADAPTOR
2		1PC	PLUG WITH WIRE
3		1PC	Y-CABLE
4		1PC	PLUG WITH WIRE FOR LED LIGHT

Step#1

Back Rest Installation

Align the female brackets at the back onto the male brackets at the seat, insert back rest to the seat then push to the end and make sure it is fixed in position securely. Connecting the wire from back rest to seat for power headrest.

Unpack adaptor set located at the bracket

Back Rest Installation

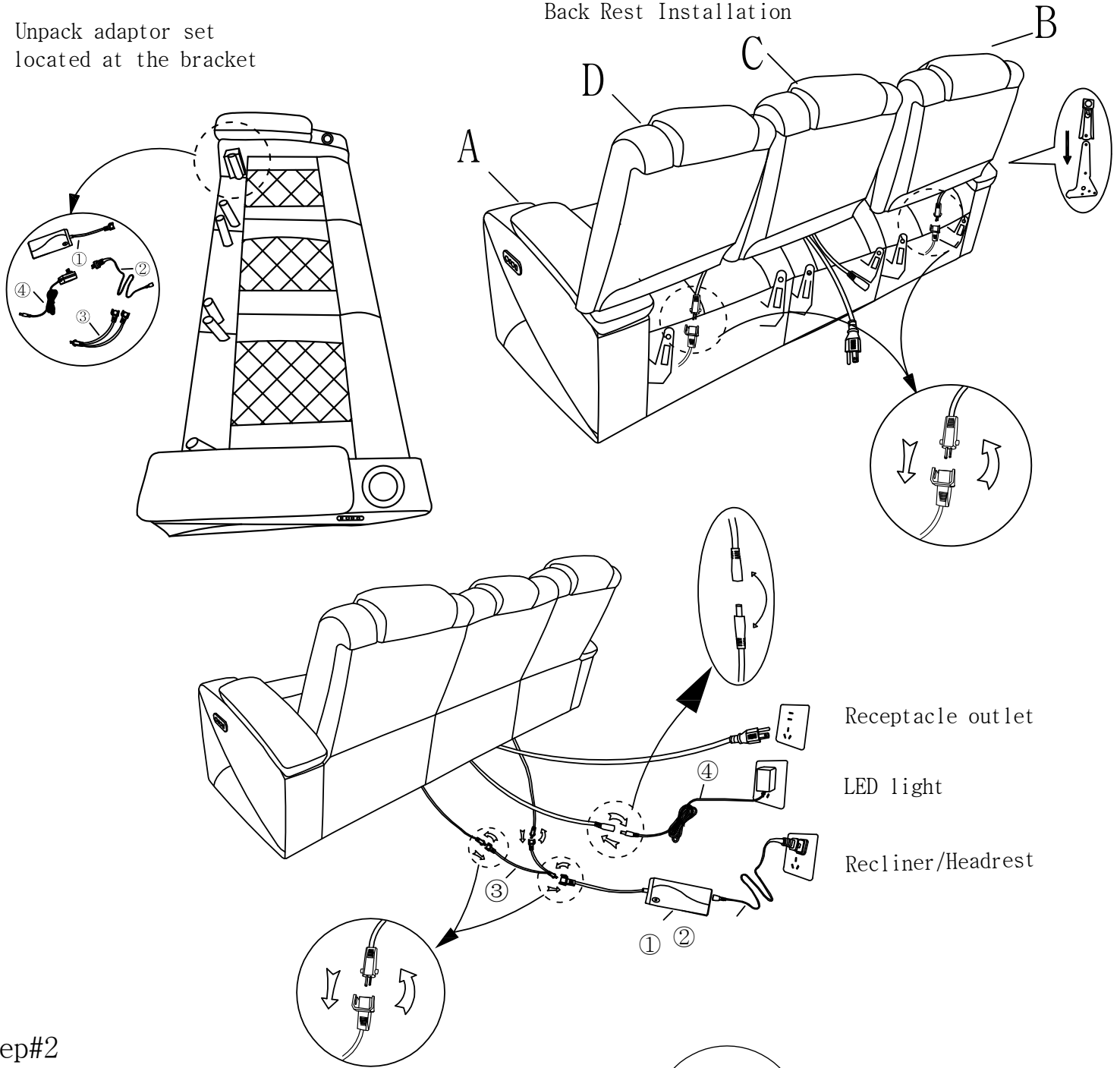

Step#2

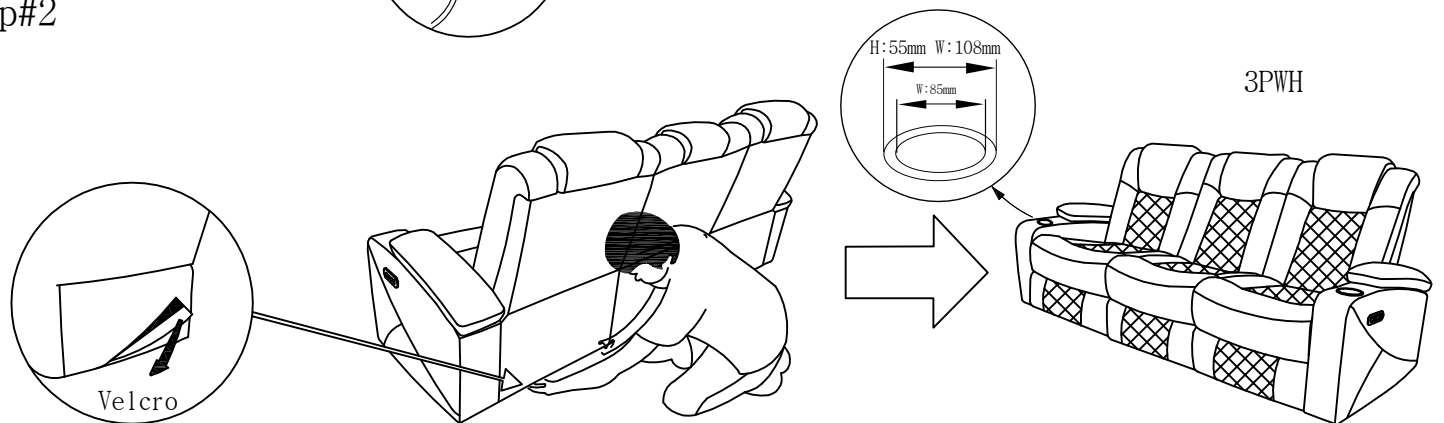

3PWH

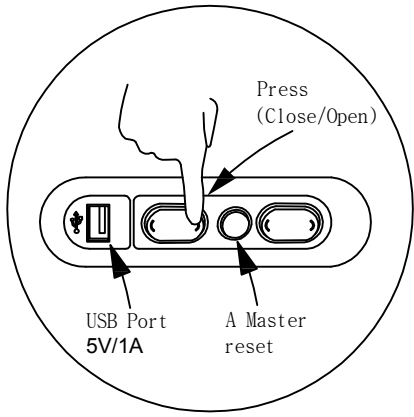

Headrest

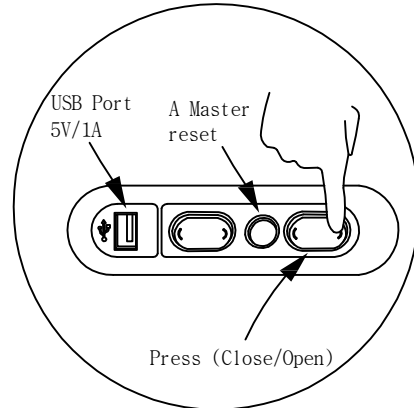
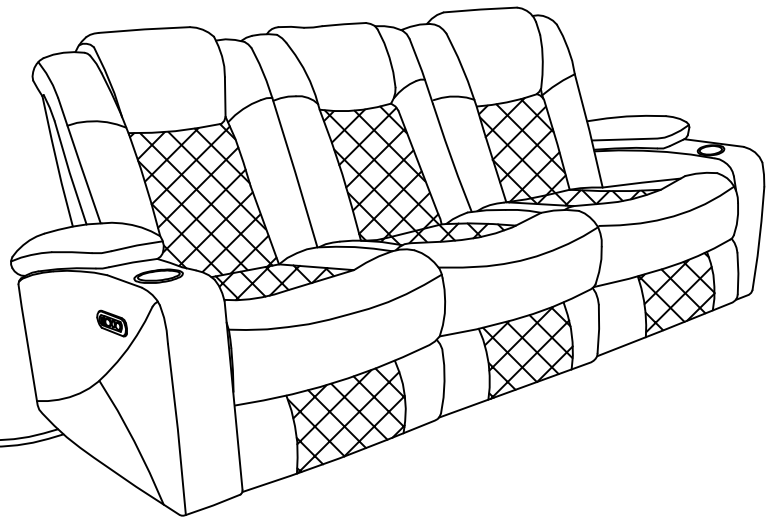

Chair

Control Switch

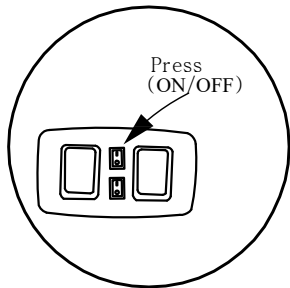

LED Light

Receptacle with USB port

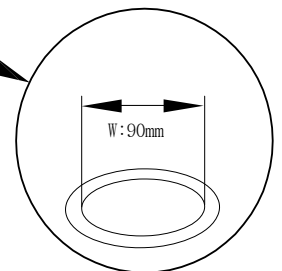
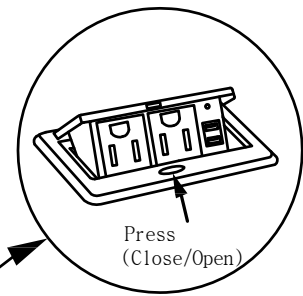
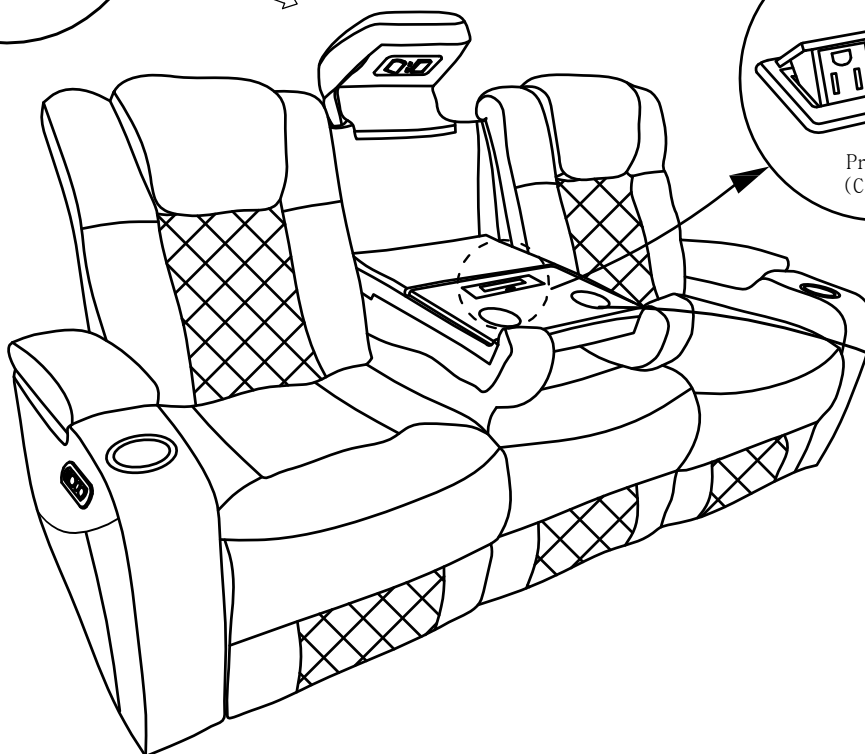

CARE INSTRUCTION FOR LEATHER GEL

In order to maintain the original appearance of your leather gel furniture, please follow below simple care procedure:

- Avoid exposing furniture directly to sunlight or heating and air conditioning outlets. Exposure to sunlight or heating and air conditioning outlets will fade/damage leather gel.
- Wipe gently with a damp soft cloth to remove dust dirt and any grime build up.

WARNING

- Disconnect the electrical plug from the wall outlets before cleaning, moving, servicing or when not in use for an extended period of time.
- Plug directly into a wall outlet. Do not use an extension cord or adaptor.
- Check the condition of the power transformers, electrical cords, plugs and connectors monthly. Keep the power adaptor and electrical cords away from heat sources. Never operate the unit with a damaged power adaptor, electrical cord, plug or connector.
- Before moving the product, please disconnect the electrical plug from the wall outlet and secure the mechanism to prevent unexpected opening or movement. Never move the product by the mechanism, legrest, handle, or reclining back.
- Do not attempt to disassemble or service the adaptor or motor. No serviceable parts are inside.
- Do not allow electrical cord to be pinched between moving parts or between the frame and the floor. Do not place cord under carpet or in location where it could become worn.
- Unplug the power cord immediately if you detect strange odors or fumes coming from the chair.

PLEASE KEEP ASSEMBLY INSTRUCTION FOR FUTURE REFERENCE