

Product Instructions for:

**Grey Micro/ Khaki Micro
Storage Lounge**

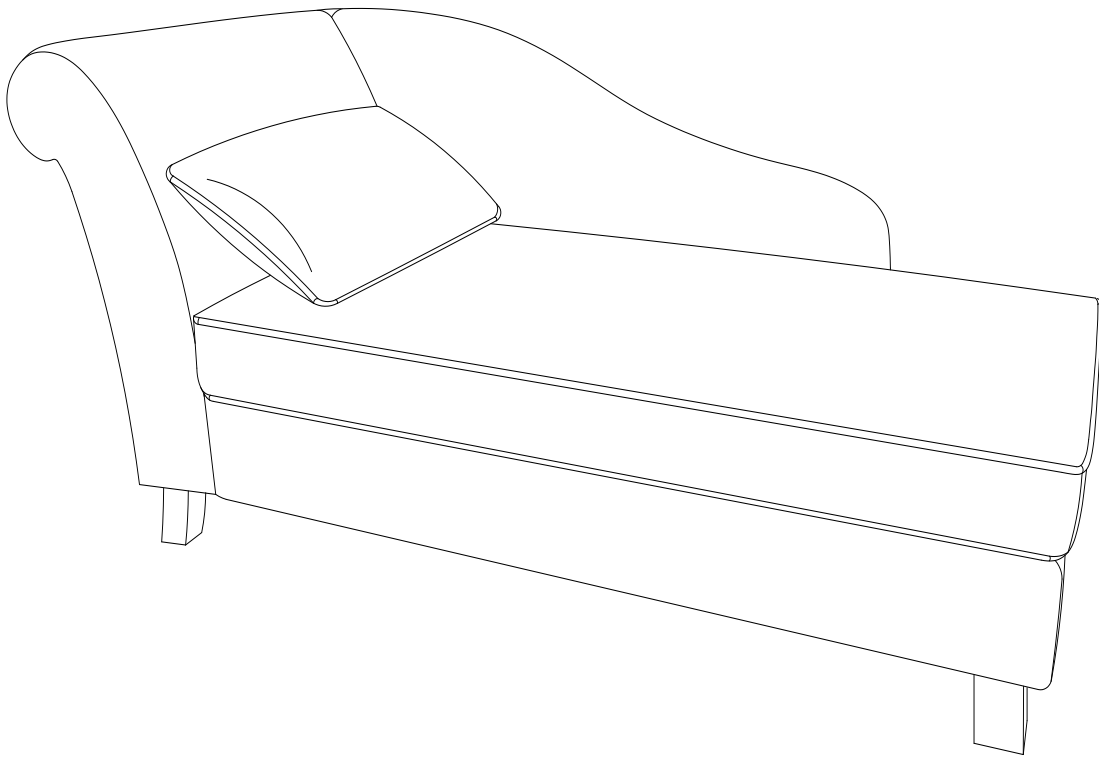

NOTE: Before you get started, remember to loosely attach all bolts. Once product is fully assembled, set product upright. Press down evenly on all sides until product sits level then fully tighten all bolts.

Grey Micro/ Khaki Micro Storage Lounge

Before beginning assembly, separate all parts and carefully study the parts diagrams below. Review all parts and hardware before disposing of any packaging. You may receive extra hardware with your unit.
Call Customer Service for missing hardware.

Parts list

A: Seat (1)

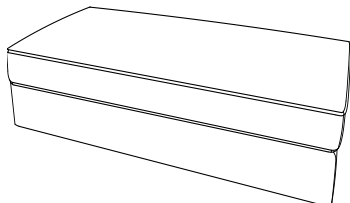

B: Back Panel (1)

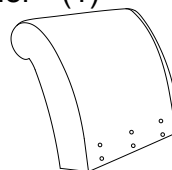

C: Side Panel (1)

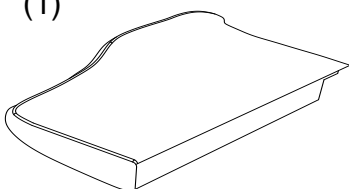

D: Front Legs (2)

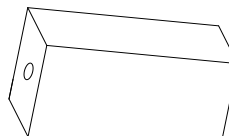

E: Back Legs (2)

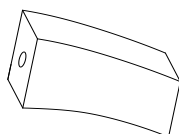

F: Pillow (1)

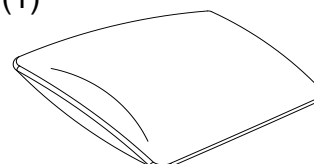

(4) 1: Bolt: 5/16" * 2-1/2" L (18)

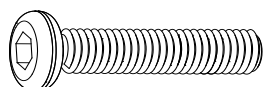

2: Spring Washer (18)



3: Flat Washer (18)



4: Allen Wrench (1)

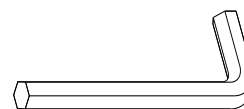

5: Plastic Plug(4)

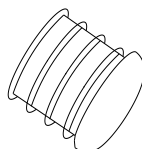

Grey Micro/ Khaki Micro Storage Lounge

Assembly Instructions

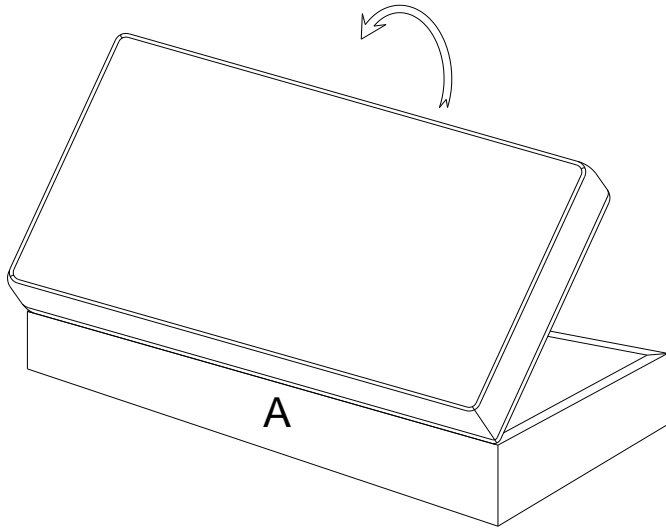

Figure 1

Step 1

Unpack and lay parts on clean, padded surface like carpet or blanket. Check that you have all parts indicated on the front page.

Open the Seat's (A) cover and keep the Seat's (part A) cover open.

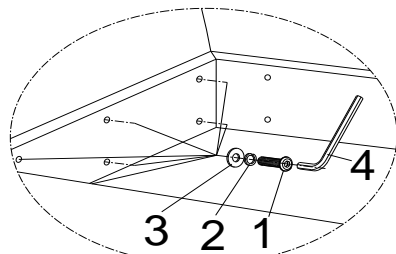

Figure 2

Step 2

Attach Back Panel (B) to Seat (A) by Bolts (1) and Spring Washer (2) and Flat Washer (3), Tighten them by using Allen Wrench (4) as shown in Figure 2.

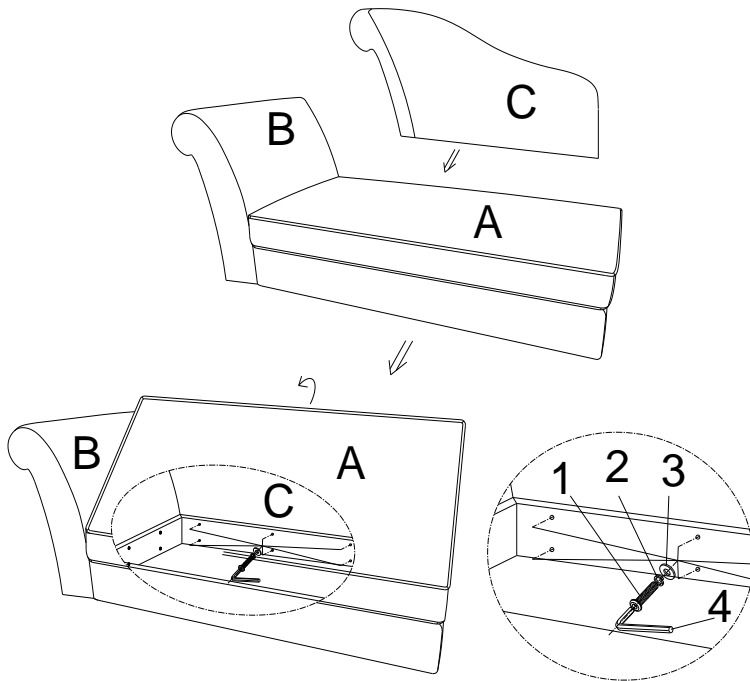

Figure 3

Step 3

Attach Side Panel (C) to Seat (A) and Back Panel (B) by Bolts (1) and Spring Washer (2) and Flat Washer (3).

Tighten them by using Allen Wrench (4) as shown in Figure 3.

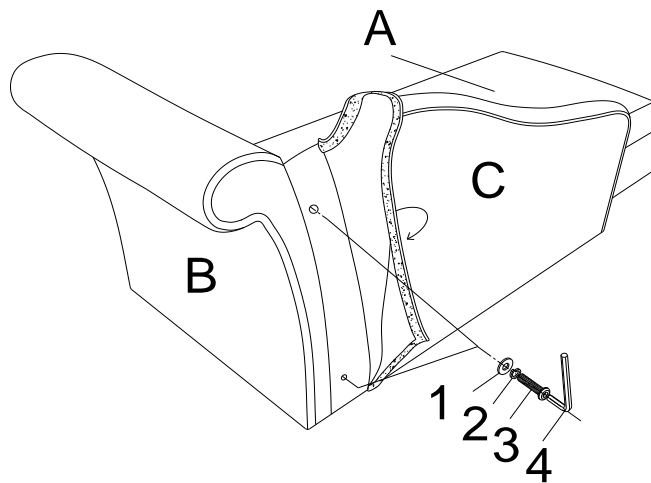

Figure 4

Step 4

Lift the Velcro strip from the Side of side panel (C)

Insert Bolt (3) and Spring Washers (2) and Flat Washers (1) into inside pre-drilled holes, tighten Bolt (3) by Allen Wrench (4) as shown in figure 4.

Then close Velcro strip on the side of Side Panel (part C)

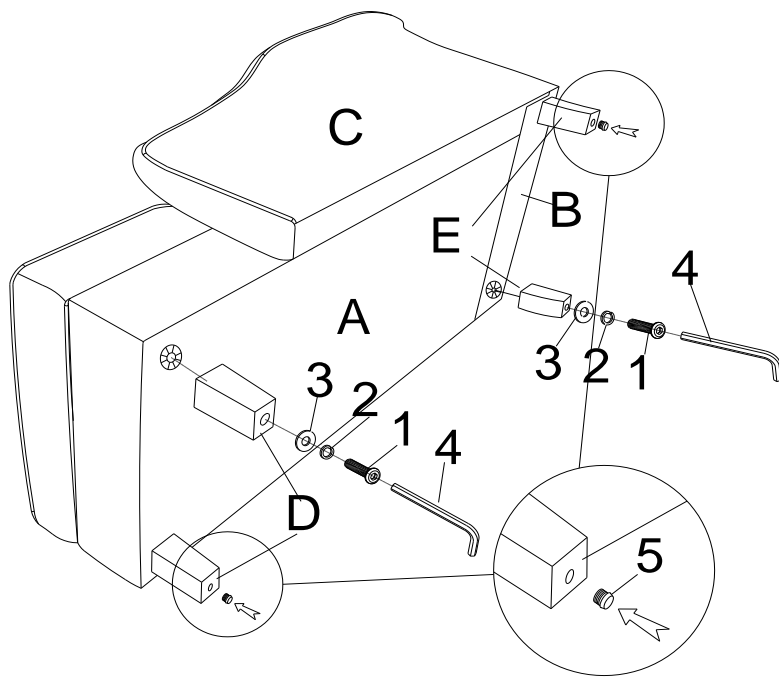

Figure 5

Step 5

Insert Blots (1) and Spring Washer (2) and Flat Washer (3) into holes of Legs (D/E), Tighten them by using Allen Wrench(4), Then insert the Plastic Plug (5) to the Legs (D/E) as shown in figure 5.

Please make sure all legs are in the proper orientation.

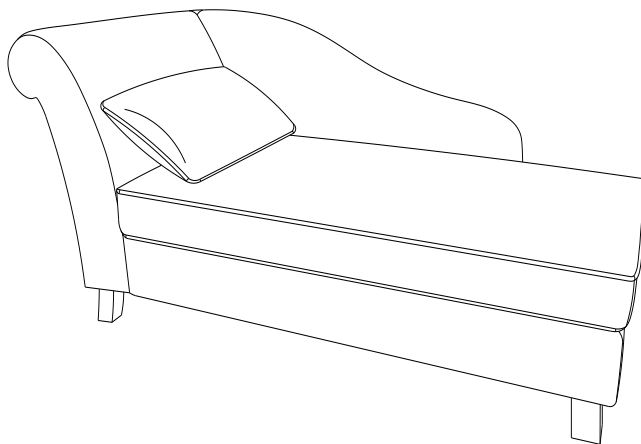

Figure 6

Step 6

Turn over the lounge,

Then place the Pillow (F) on the lounge as shown.

Now your lounge is ready to use!