

USER'S MANUAL

Vanity Table Set

THIS INSTRUCTION BOOKLET CONTAINS **IMPORTANT** SAFETY INFORMATION. PLEASE READ AND KEEP FOR FUTURE REFERENCE.

Please give us a chance to make it right and do better!

Contact our friendly customer service department for help first.







Replacements for missing or damaged parts will be shipped ASAP!











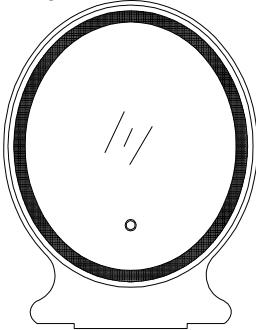
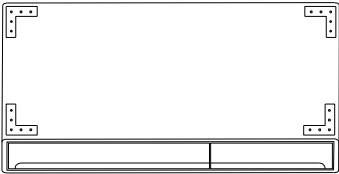

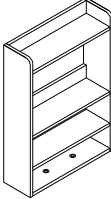
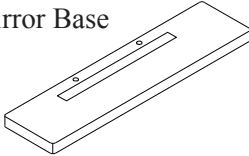

Contact Us!

Do NOT return this item.

Contact our friendly customer service department for help first.

Before You Start

-  Please read all instructions carefully.
-  Retain instructions for future reference.
-  Separate and count all parts and hardware.
-  Read through each step carefully and follow the proper order.
-  We recommend that, where possible, all items are assembled near to the area in which they will be placed in use, to avoid moving the product unnecessarily once assembled.
-  Always place the product on a flat, steady and stable surface.
-  Keep all small parts and packaging materials for this product away from babies and children as they potentially pose a serious choking hazard.

A*1 Mirror 		B*1 Table Top 		
C*1 Stool Seat 		D*1 Tabletop Storage Rack 		
E*1 Mirror Base 		P*1 Drawer 		
F1*4 Table Leg 		F2*4 Stool Leg 	G*1 Knob 	
H*42 2 Spare 	I*3 	J*2 	K*2 	L*8 Foot Pad 
M*1 Hex Wrench 	O*1 Interface Plug 			

Please check and make sure that you have got all the parts and hardware on the list. When installing, please make sure that the installation number in the first step is consistent with the subsequent installation number. If any parts are missing, please mark them and contact us at any time.

STEP 1:

Fix the table leg (F1) on the four corners on the back of the table top (B) with screws (H), as shown in the figure, each table leg uses 5 screws (H), a total of 20 are used.

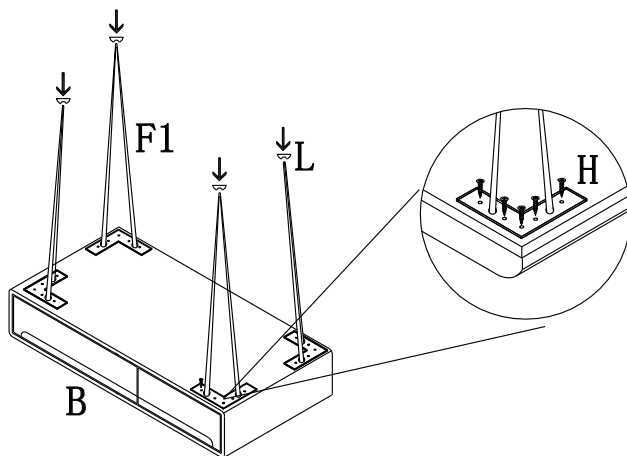

STEP 2:

The installation method is the same as the first step. Use screws (H) to fix the stool legs (F2) on the four corners on the back of the makeup stool (C). As shown in the figure, each leg uses 5 screws (H), and there are 20 in total.

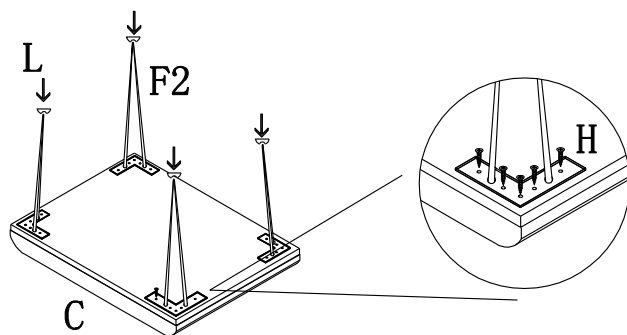

STEP 3:

Fix the makeup mirror (A) and the base (E) with 3pcs screws(I).

Then fix the base (E) on the desktop with 2pcs screw (J) and the wrench (M), as shown in the figure, and then connect the plug (O) .

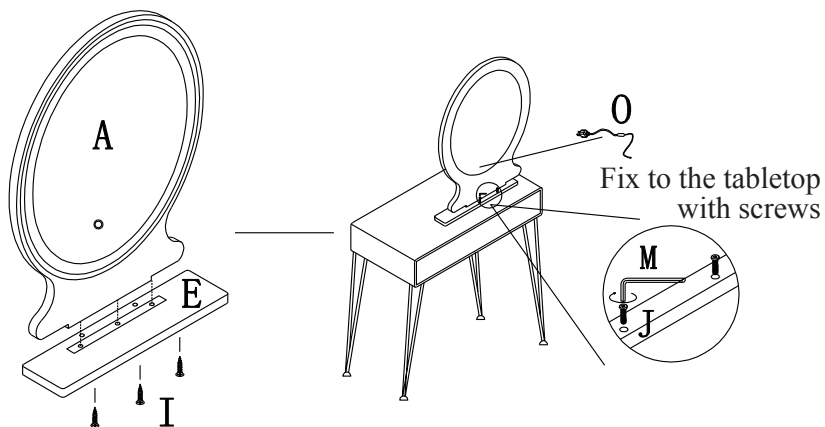

STEP 4:

Fix the tabletop storage rack (D) on the tabletop with a wrench (M) and 2pcs screws (K), as shown in the figure. Then put the small drawer (P) under the tabletop storage rack (D).

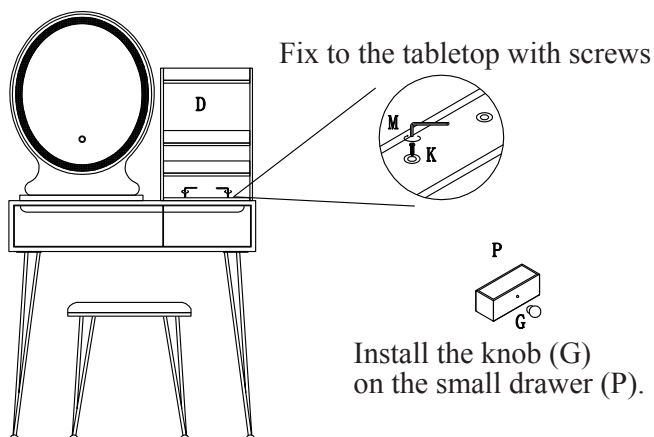

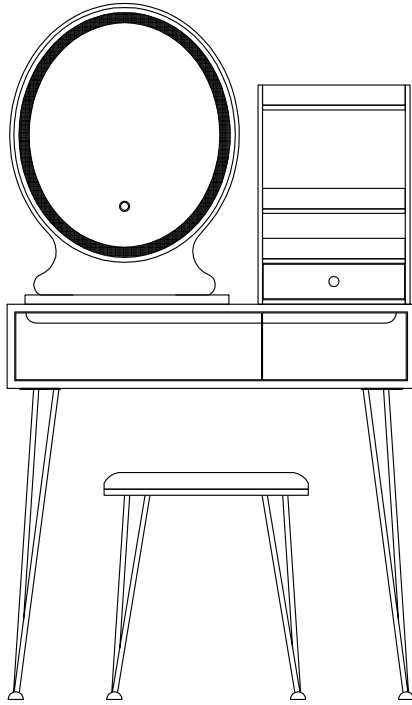

Light Button

1. In any mode, short touch to turn on the light, short touch again to switch the light, the light is available in three colors.
2. In the light-on mode, long touch to enter the stepless dimming state (adjust the brightness of the light), and cycle in turn.