

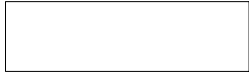











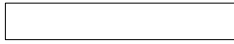

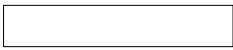

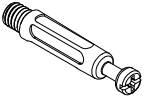

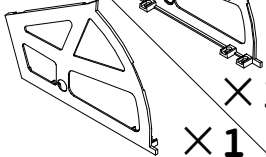
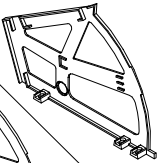
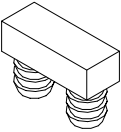
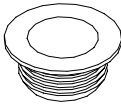

1		1000*450*12=1	8		450*270*16=1
2		1000*300*16=1	9		757*140*12=2
3		800*270*16=1	10		757*88*12=1
4		762*354*12=1	11		776*380*3=1
5		766*80*16=1			
6		766*80*16=1			
7		450*270*16=1			

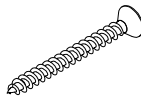
A		B		C		D		E1		E2	
	× 12		× 12		× 1		× 2		× 1		× 1
F		G		H		I		J			
	× 2		× 2		× 2		× 8		× 18		
K		L		M		N		O			
	× 2		× 2		× 8		× 8		× 6		

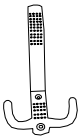

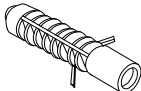
1

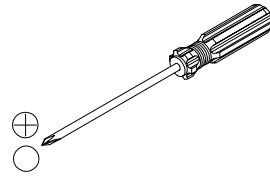
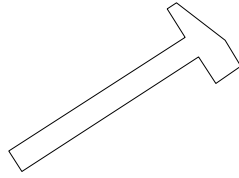
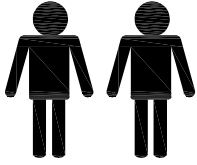

2

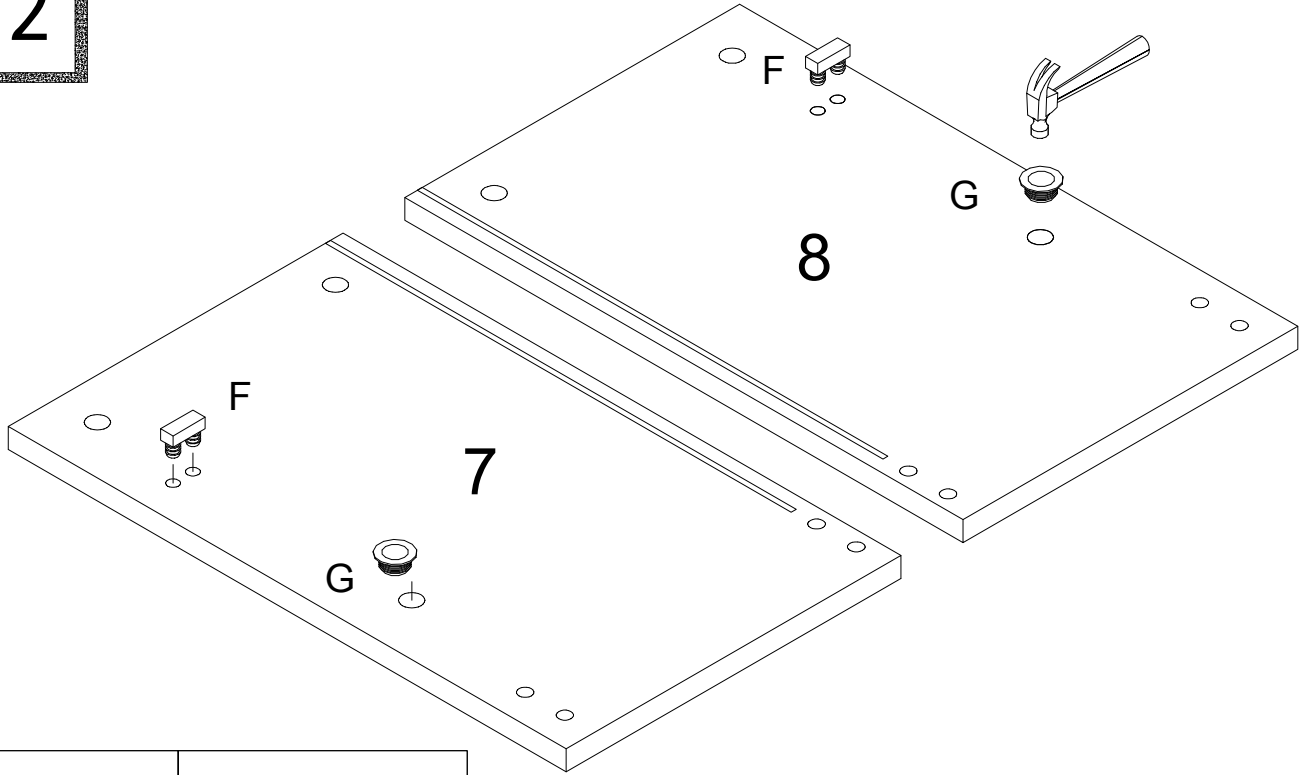

F 2 PCS



G 2 PCS



3

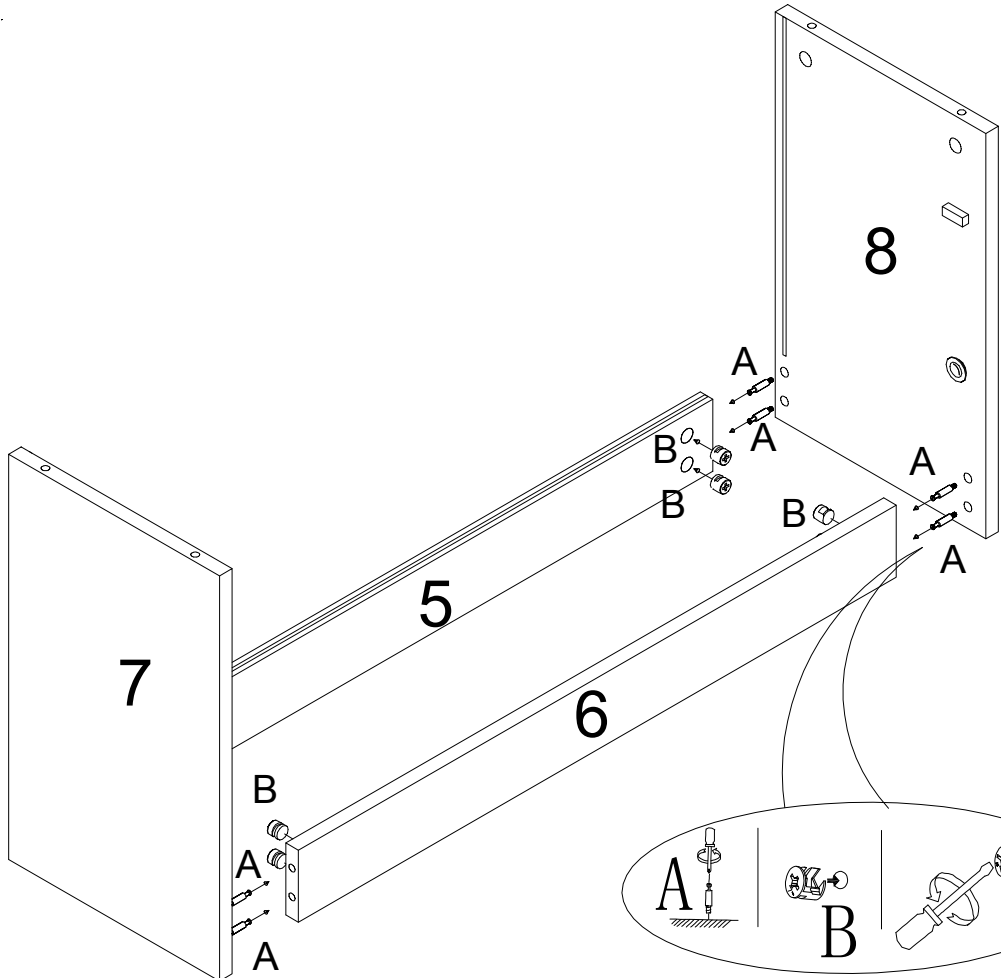

A 8 PCS

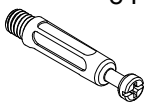

B 8 PCS



3

4

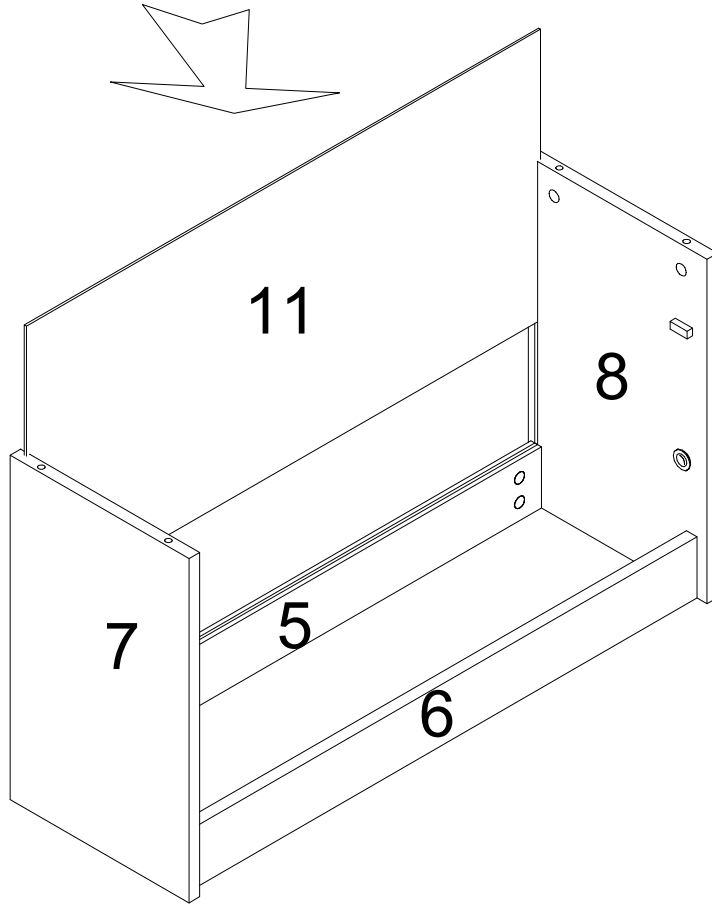



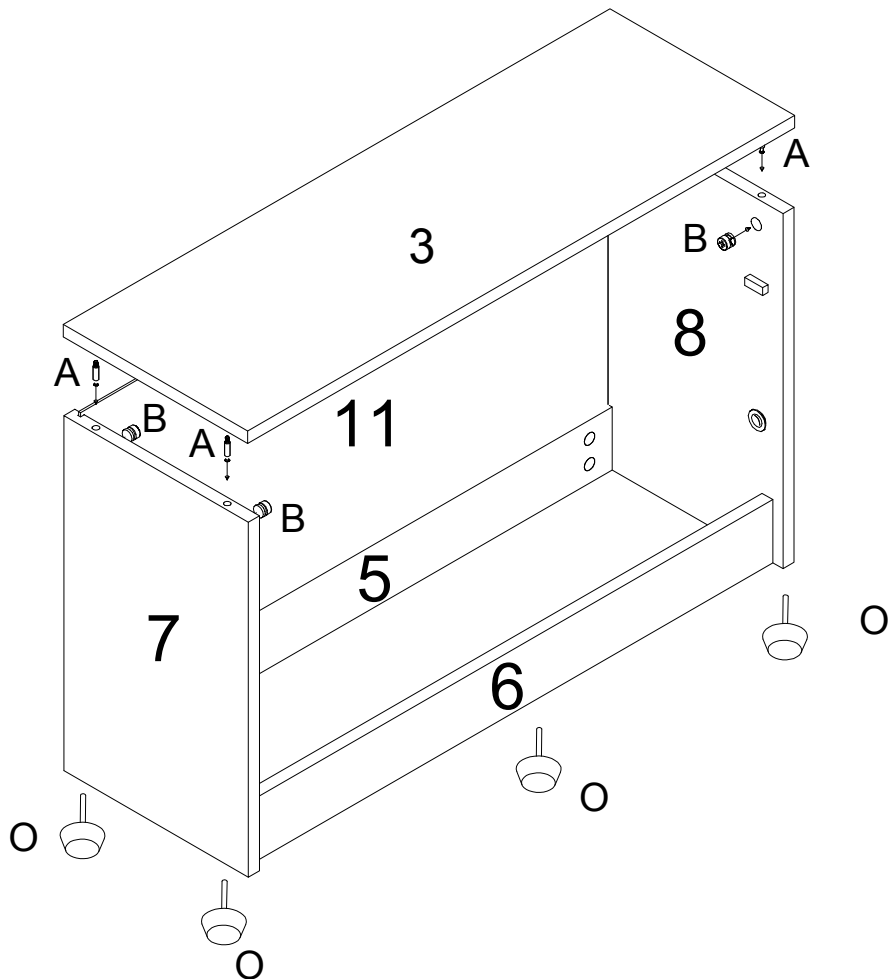

5

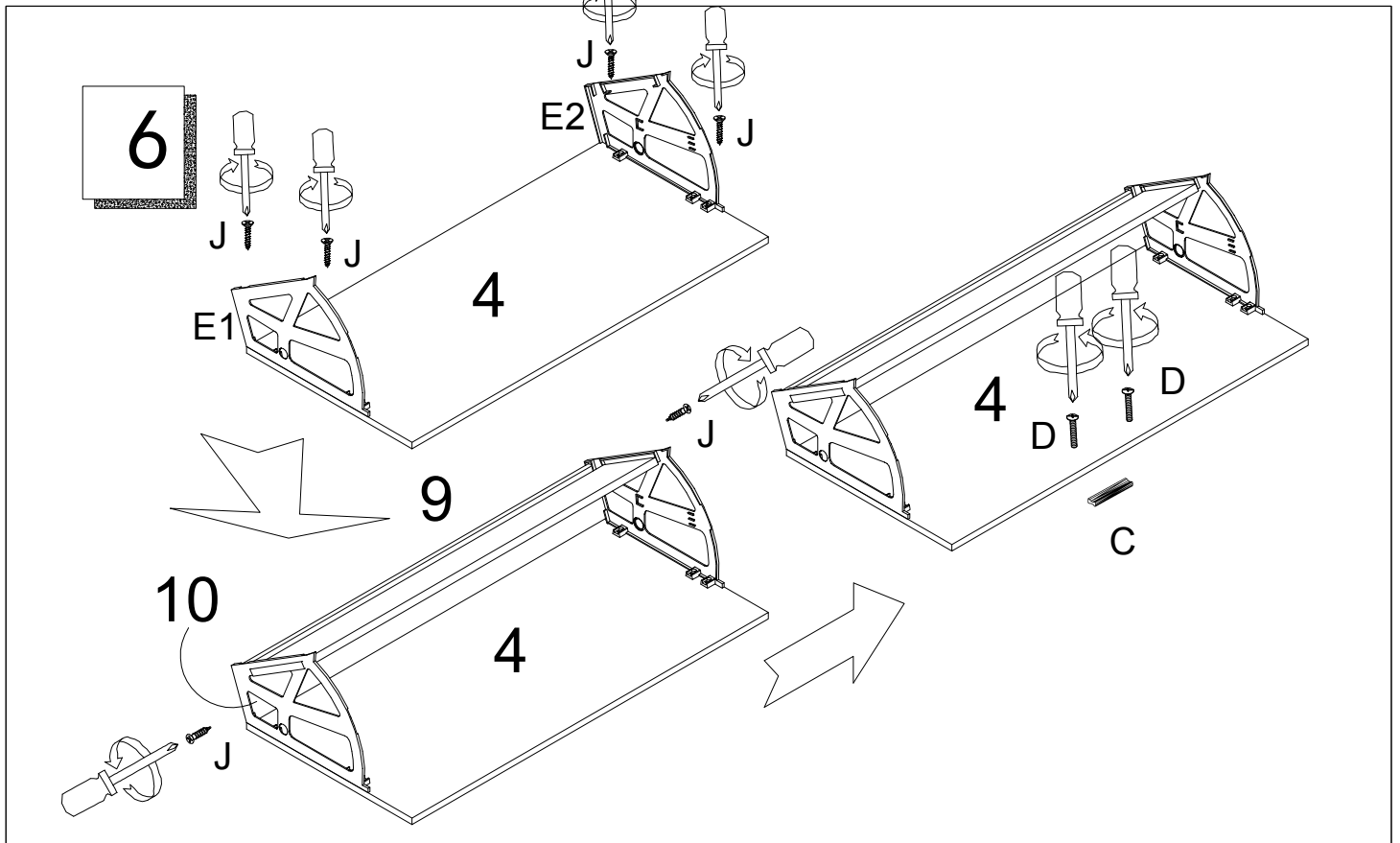

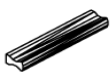

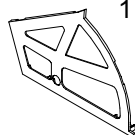
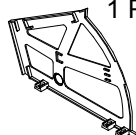
O	6 PCS
A	4 PCS
B	4 PCS

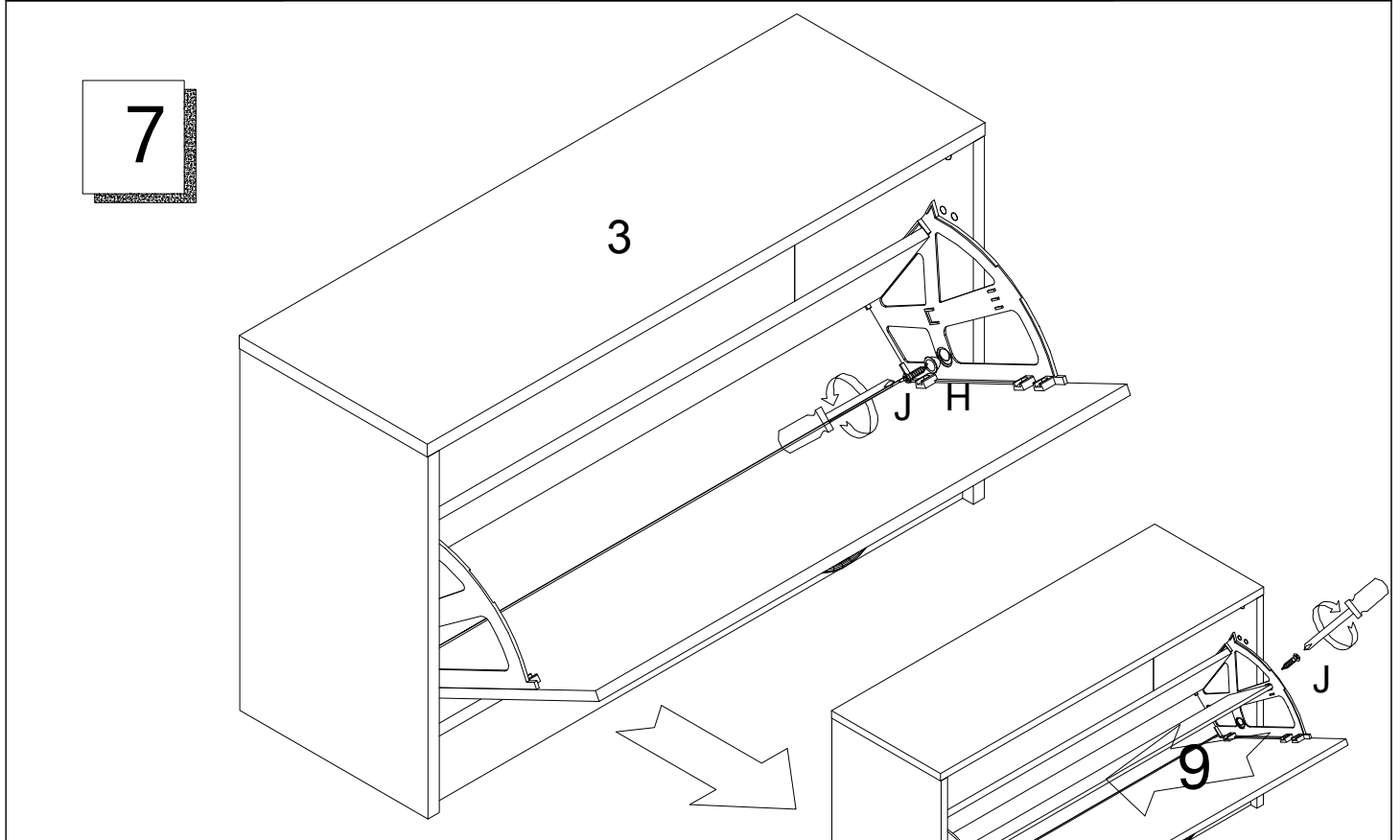

<p><b>C</b> 1 PCS</p> 	<p><b>D</b> 2 PCS</p> 	<p><b>E1</b> 1 PCS</p> 	<p><b>E2</b> 1 PCS</p> 	<p><b>J</b> 6 PCS</p> 
---	---	---	---	---



<p><b>H</b> 2 PCS</p> 	<p><b>J</b> 2 PCS</p> 	<p><b>J</b> 2 PCS</p> 	<p><b>5</b></p> 
---	---	---	---

8

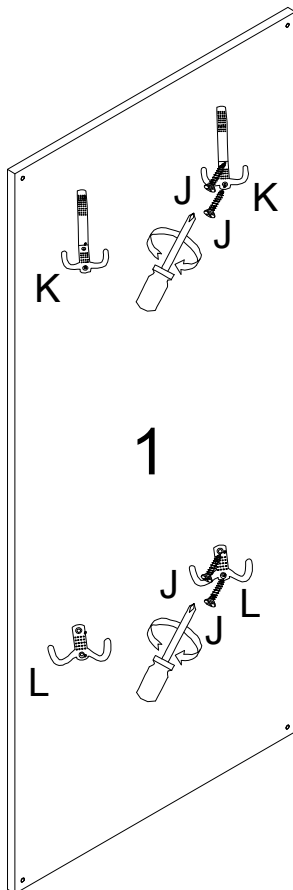

K 2 PCS



L 2 PCS



J 8 PCS



9

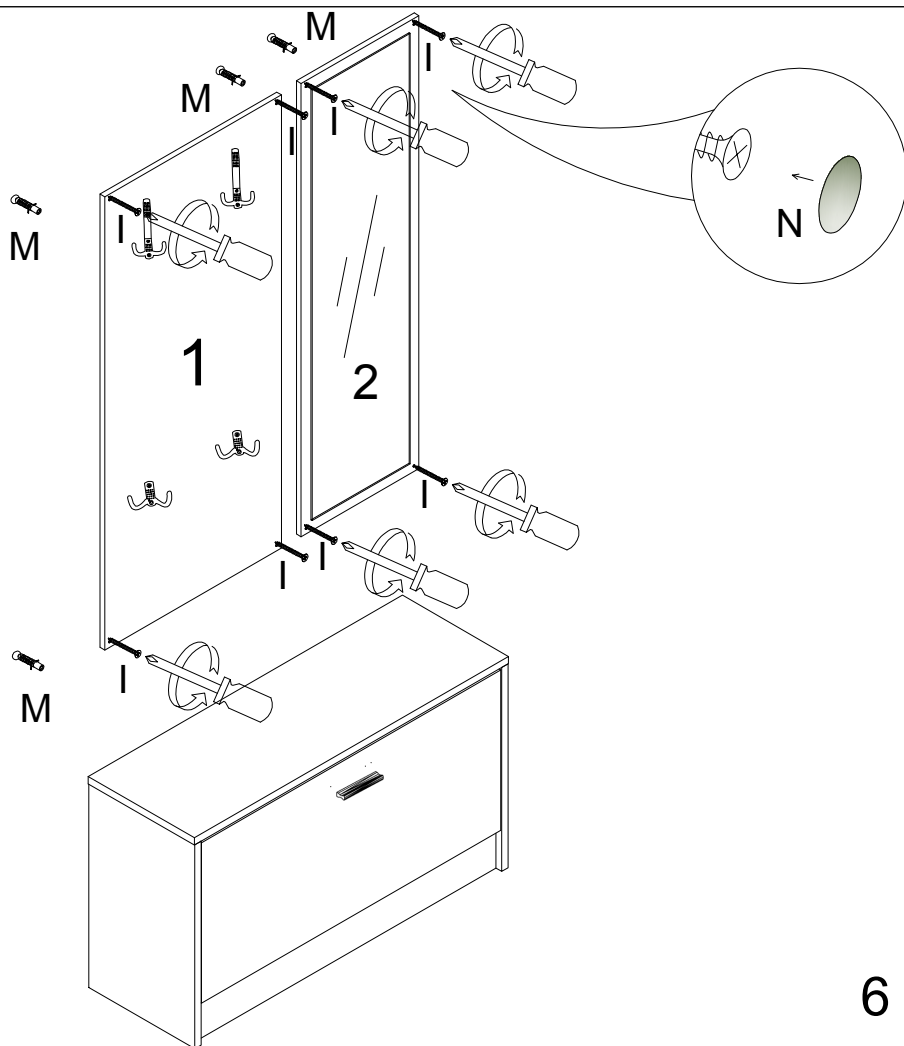

M 8 PCS

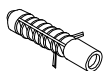

I 8 PCS



N 8 PCS



6