

USER'S MANUAL

Beach Umbrella



THIS INSTRUCTION BOOKLET CONTAINS
IMPORTANT SAFETY INFORMATION.
PLEASE READ AND KEEP FOR FUTURE REFERENCE.





▲ SAFETY NOTES

- **IMPORTANT!** Always close or put down the umbrella when not in use. Do not use or assemble the umbrella in heavy winds, rain, thunderstorms, or snow. In such weather conditions, it is recommended to fold down or disassemble the umbrella.
 - **IMPORTANT!** Keep children and pets away while setting up the umbrella. Children must always be supervised around the umbrella.
To prevent damage, face the canopy against the wind.
 - **WARNING!** Do not light any fires under or near the umbrella!
This umbrella is for outdoor use only and is primarily intended to be used as a sunshade, not as wind protection.
This product has been tested for both domestic and commercial use.
-

💧 CARE INSTRUCTIONS

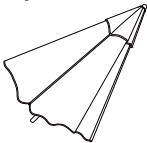
- **Canopy Cleaning:** To clean the canopy fabric, use mild soap or warm water with a clean, dry cloth or a soft brush to remove spots. Never use solvent-based detergents, as these may bleach the material and damage the fabric. Do not use alkali or acidic detergents or steam cleaners.
- **Frame Cleaning:** To clean the umbrella frame, wipe it with a mild soap solution. It is not recommended to clean plastic or metal products with strong cleaners or abrasive materials, as they may discolor or damage the surface.
The umbrella frame is painted with a powder coating of plastic paint for protection. The frame will not be protected once the coating is damaged (e.g., rusting).
- **Frame Repair:** To repair a damaged frame, repaint it to restore its protective coating.

PART LISTS

A x1 	B x1 	C x1 	D x1 
Umbrella head	Umbrella bag	Umbrella handle	Hook

TO SET UP THE UMBRELLA

STEP 1

Insert the umbrella pole into the sand and rotate the pole until the threaded part is fully submerged in the sand.
(You can assist by inserting a metal rod into the umbrella pole to help rotate it for installation.)

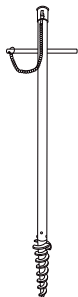

STEP 2

Slide the hook onto the upper umbrella pole, then tighten the knob to secure it.

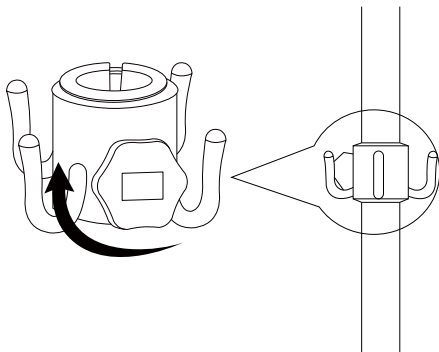

STEP 3

Insert the umbrella canopy into the umbrella pole and tighten the adjustment handle.

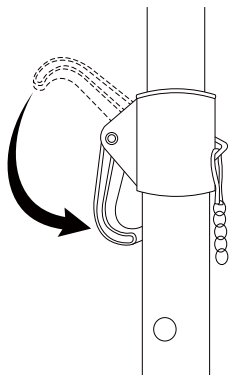

STEP 4

Open the umbrella fabric upwards. Listen for a "click" sound to confirm that the umbrella canopy is securely fixed.

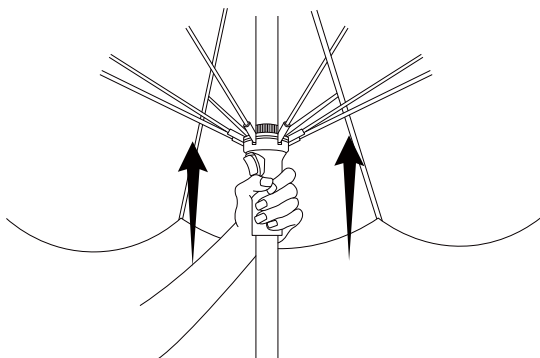

STEP 5

Press the button to tilt the umbrella canopy (both sides can be adjusted by an angle of 30° each).

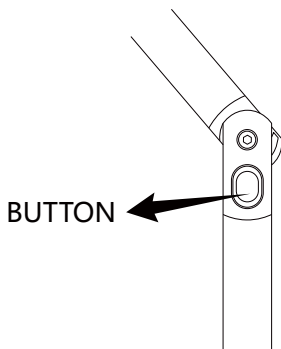

HOW TO CLOSE THE UMBRELLA

STEP 1

Loosen the adjustment handle and pull out the umbrella canopy.

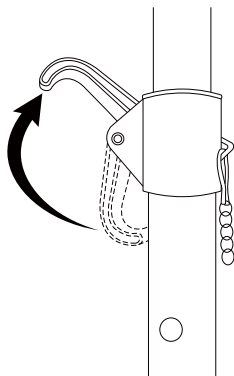

STEP 2

Rotate the knob on the hook counterclockwise to release it, then remove the hook. (If the hook is not removed, the umbrella may not fit into the storage bag.)

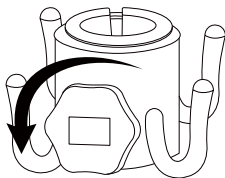

STEP 3

Press the button on the umbrella canopy and close the umbrella.

