

Owner Manual

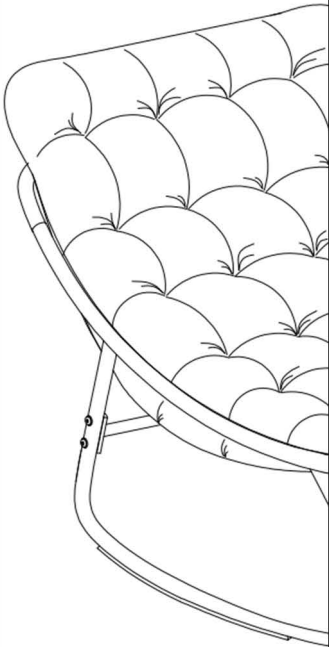

WARRANTY

We strive to offer high quality product and we also try our best to satisfy each customer that order from us, no matter on products or services as needed. Each customer receives a record of their order, such as the order number or item receipt. For any items that are out of warranty period, you may still be able to purchase the replacement parts from our company if they are available.



MAINTENANCE AND WARNING

Please read the manual thoroughly
before you start installing.

Please keep the product away from
sharp object.

Packaging and small parts may have
chocking hazard, please keep them away
from children and pets.

Please clean the product according to each
clean code, check the product description
for more information.

Please keep the product away from
fire.

If you have any other questions, please
contact us, we will be glad to help you out.

If the product is placed under direct
sunlight, the pattern or color might fade
away overtime.

Check the product periodically to make
sure everything is secured and tightened.

Always use proper tools for installation.

Do not jump on the product.

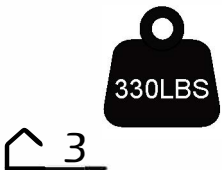

PRODUCT DESCRIPTION

Crafted with a powder coated steel frame, this rocking chair offers unmatched durability and can support up to 330 lbs.

The UV resistant, waterproof cushion ensures your comfort in all weather conditions, whether it's sunny or rainy.

Featuring a clean, armless design, the chair offers greater freedom of movement, perfect for lounging.

With the rocking function, this chair is much more comfortable than normal outdoor chairs.

Whether you're enjoying the sun or cooling off in the shade, this rocking chair offers both comfort and style for your outdoor space.

EXPLODED VIEW

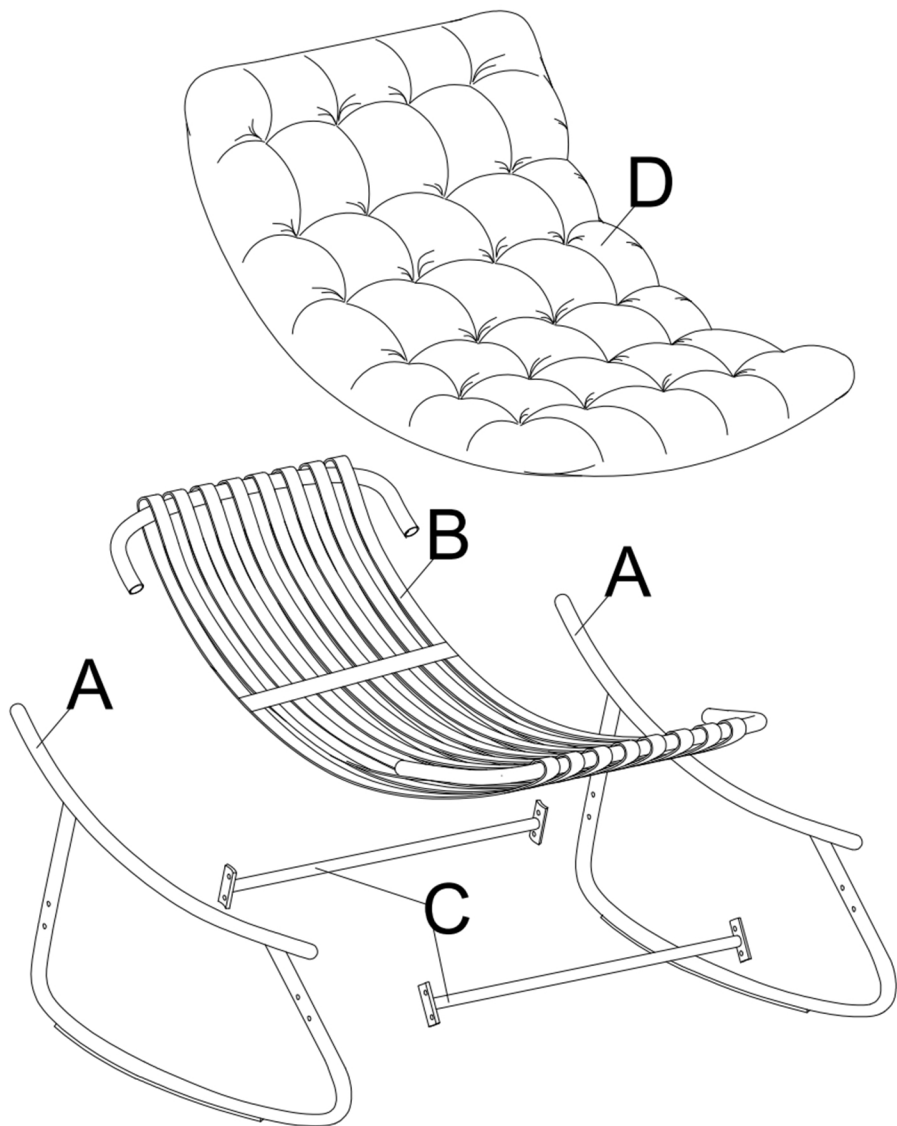

PARTS

A*2

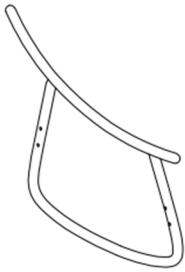

Armrest

B*1

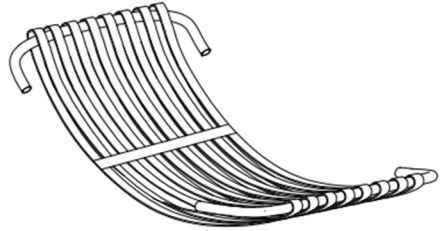

Seat frame

C*2



Rail bar

D*1

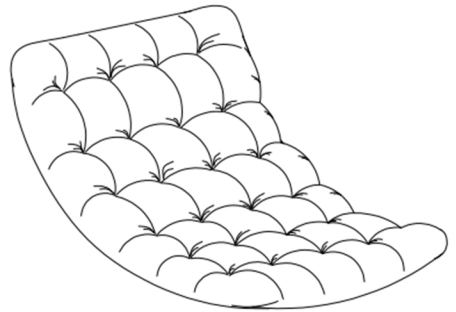

Cushion

HARDWARE

TOOL LIST

NOTE: Designated with (★) We provide additional spare parts in the hardware package

AA*8



★ M6*40mm Bolt

BB*16



★ Flat washer

CC*8



★ Nut

DD*8



★ Bolt Cap

EE*1



Allen key

FF*1



Wrench

Please make sure all hardware&packing material fitting the list. Especially some small accessories may be missing during transportation. Please contact us if you have any question.

step 1

Connect the two armrest (A) and the rail bar (C) through screw assembly. Do not completely tighten all screws until you make sure all screws are aligned correctly.

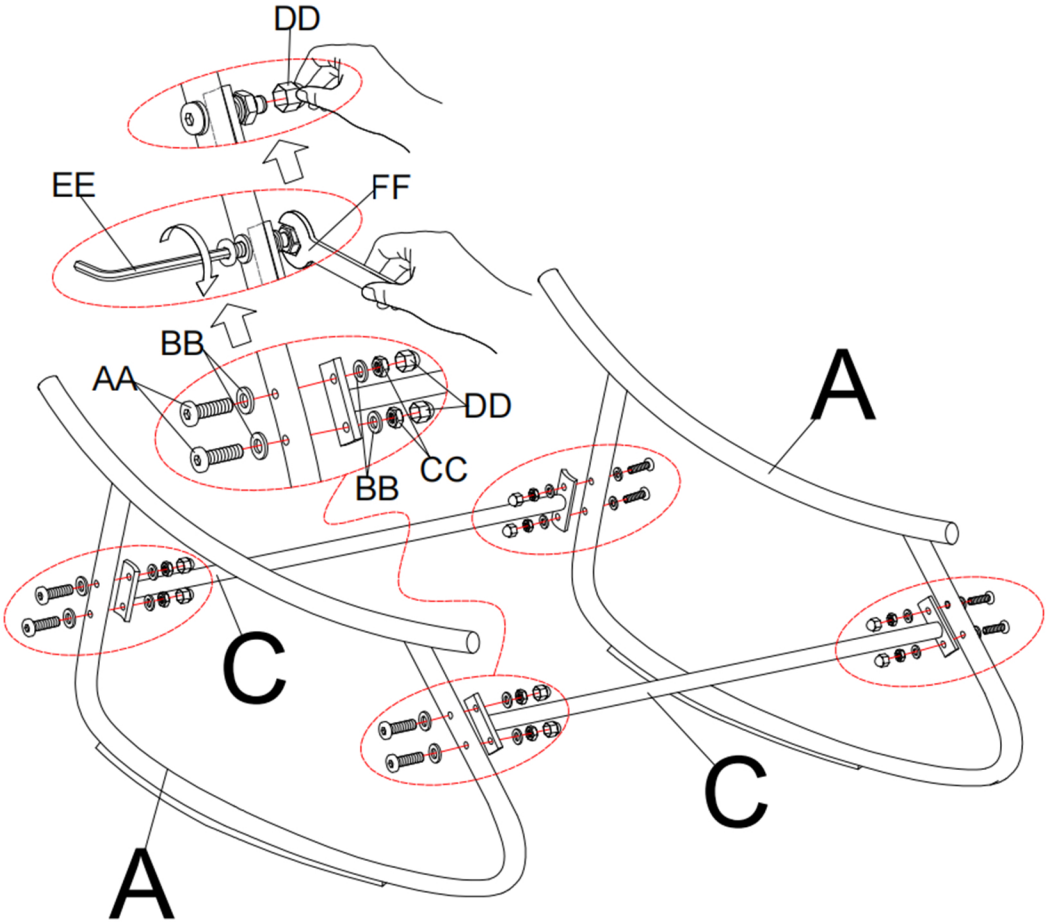

step 2

Insert the seat frame (B) into the armrest (A) from Step 1.

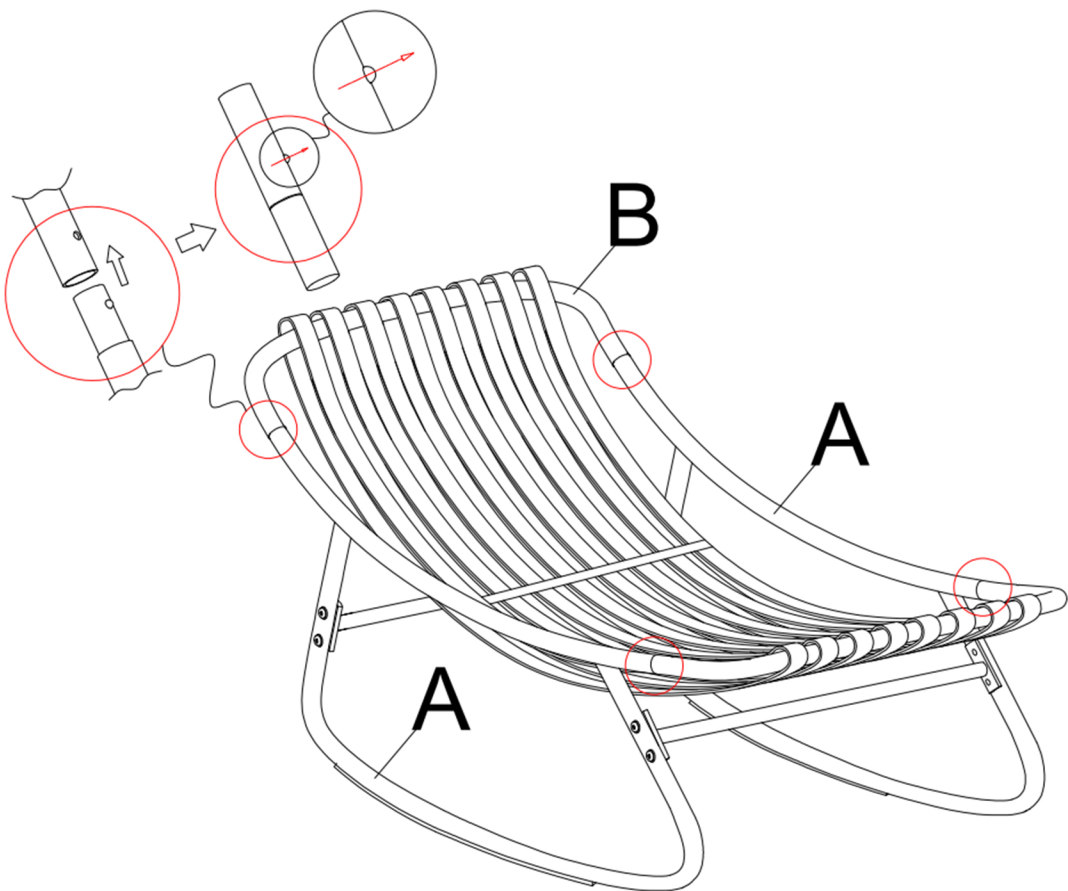

step 3

Place the cushion (D)on the chair.

