

	<p>15'</p>
		
		<p>1</p>

<p>A</p>  <p>x 1</p>	<p>B</p>  <p>x 4</p>	<p>C</p>  <p>x 1</p>	<p>D</p>  <p>M7 x 30</p> <p>x 16</p>
---	---	---	--

A

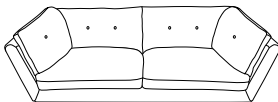

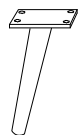

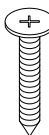
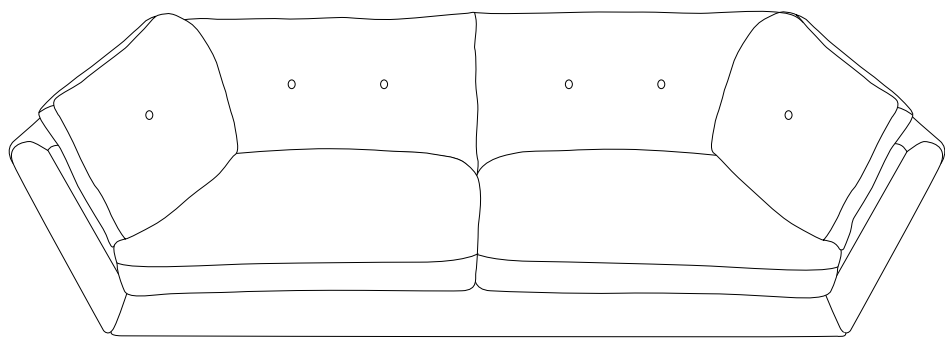
C

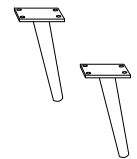
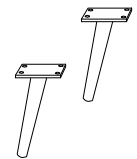

B x 4

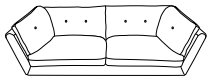

1

A  x 1	B  x 4	D  M7 x 30 x 16
--	--	--

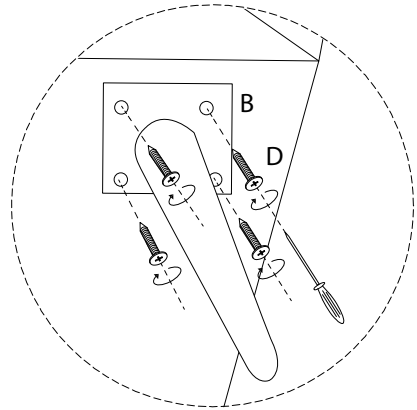
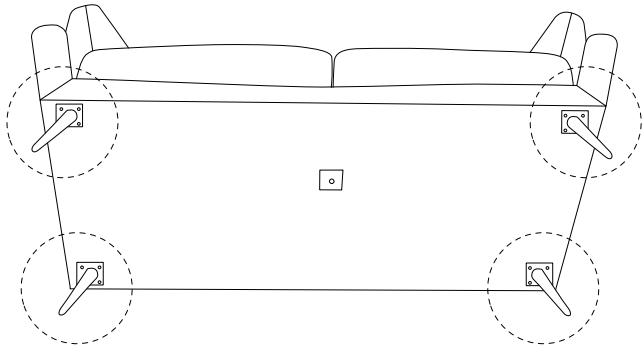

2

C  x 1
--

