







INSTALLATION & ASSEMBLY

Important note: - Place all wooden part on a clean and smooth surface such as rug or carpet to avoid the part from being scratch.
 - Please follow the assembly instruction step by step.
 - Do not tighten all screw until the chair is fully set-up.

| No | Hardware List | Qty. |
|----|--|--------|
| A | JCBC M6 x 70mm  | 16 pcs |
| B | M6 Spring Washer  | 16 pcs |
| C | M6 Flat Washer  | 16 pcs |
| D | CSK M4 x 32mm  | 8 pcs |
| E | M4 Allen Key  | 1 pc |
| F | Stopper  | 8 pcs |



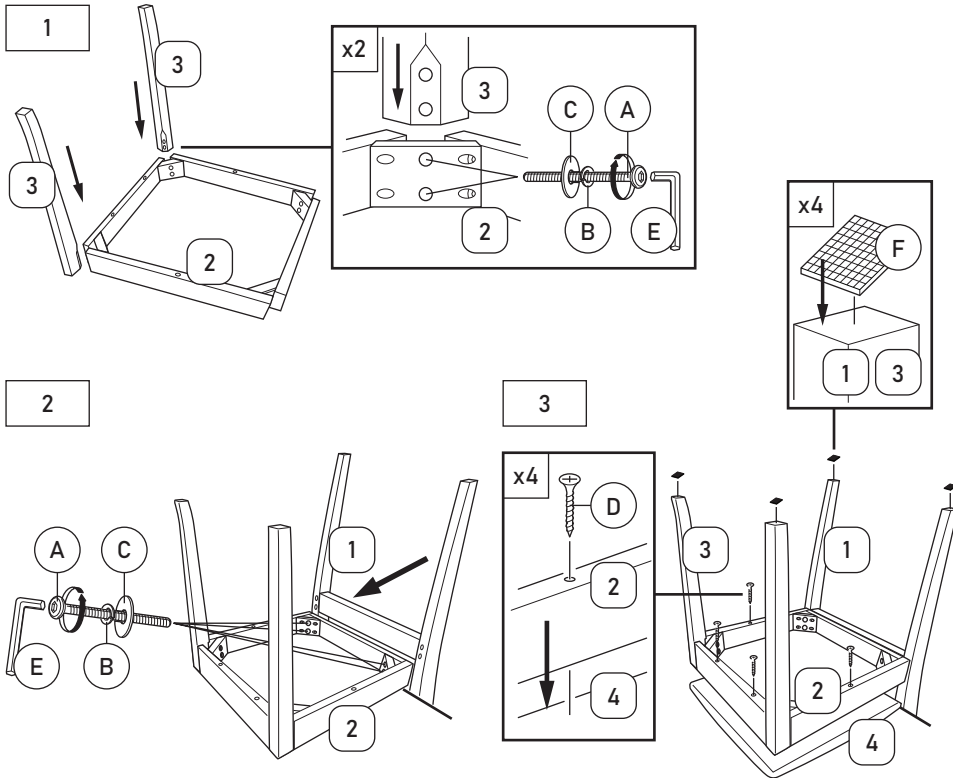



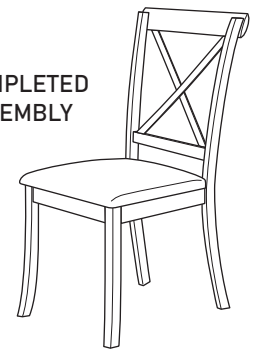

| No | Part List | Qty. |
|----|-----------------------|-------|
| 1 | Backrest | 2 pcs |
| 2 | Box Seat | 2 pcs |
| 3 | Front Leg | 4 pcs |
| 4 | Wooden Slat / Cushion | 2 pcs |

COMPLETED ASSEMBLY

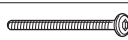

Important note: - Place all wooden part on a clean and smooth surface such as rug or carpet to avoid the part from being scratch.
 - Please follow the assembly instruction step by step.
 - Do not tighten all screw until the chair is fully set-up.

ASSEMBLY INSTRUCTION

| No | Hardware List | Qty. |
|----|--|--------|
| A | JCBC M6 x 70mm  | 16 pcs |
| B | M6 Spring Washer  | 16 pcs |
| C | M6 Flat Washer  | 16 pcs |
| D | CSK M4 x 32mm  | 8 pcs |
| E | M4 Allen Key  | 1 pc |
| F | Stopper  | 8 pcs |

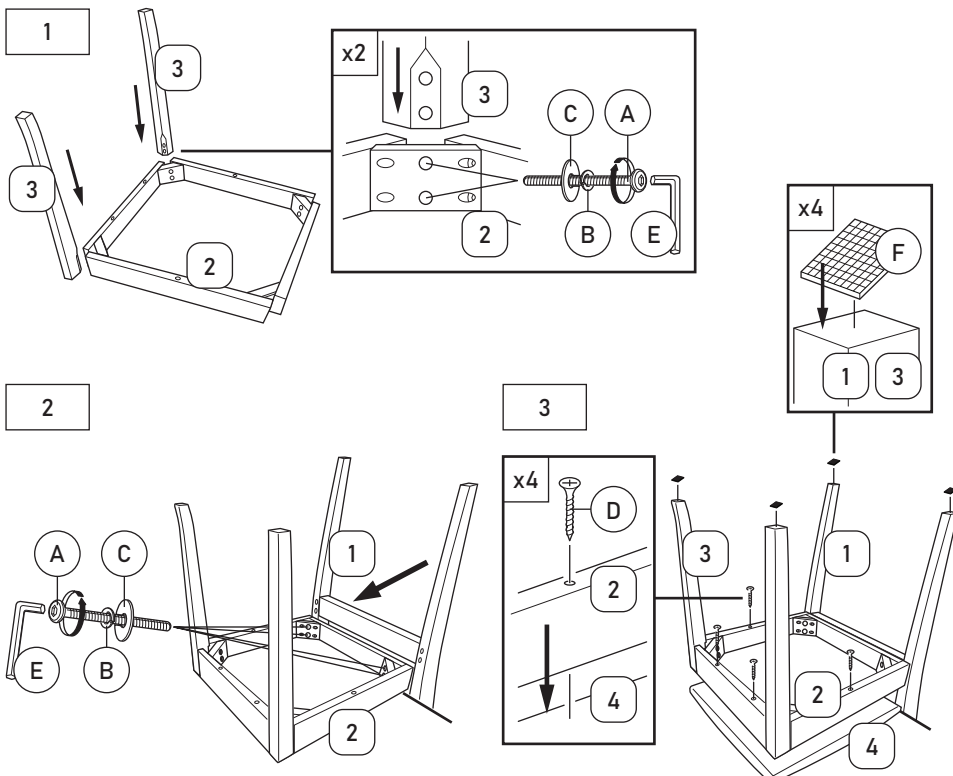

| No | Part List | Qty. |
|----|-----------------------|-------|
| 1 | Backrest | 2 pcs |
| 2 | Box Seat | 2 pcs |
| 3 | Front Leg | 4 pcs |
| 4 | Wooden Slat / Cushion | 2 pcs |

COMPLETED ASSEMBLY

