

ASSEMBLY INSTRUCTION

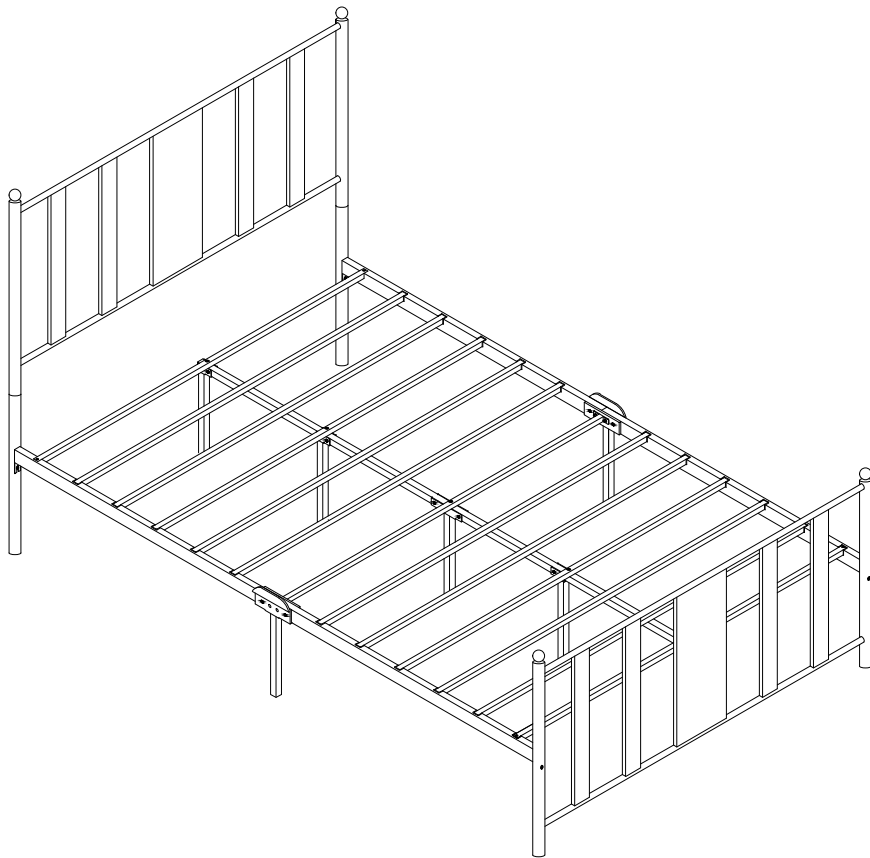

MODEL NUMBER: 608N

NOTES:







- The item is only intended to be used indoors. The product must be assembled and used in accordance with the provisions of the manual.
- It is recommended that assembly is undertaken by about 2 adults. Please read assembly instructions before assembly and strictly adhere to each step outlined. Estimated assembly time is 30 minutes.

WARNING:

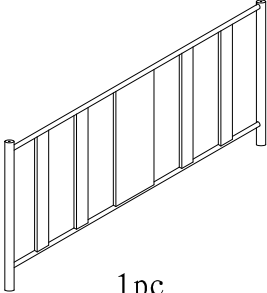
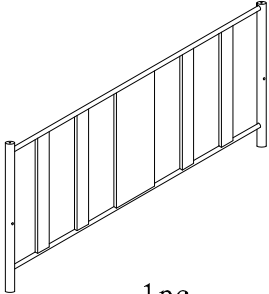
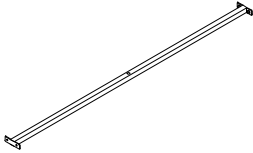
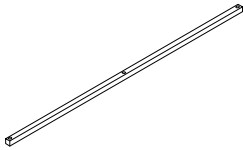
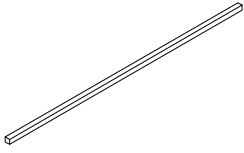
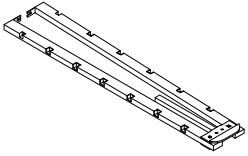
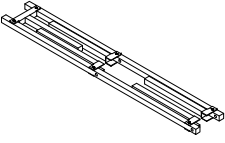
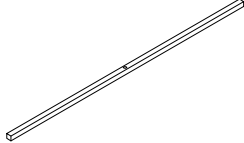
- **WARNING FOR YOUNG CHILDREN** - This product contains small components, please ensure that they are kept away from small children while assembling.

1

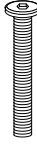
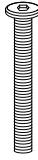
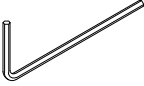
PARTS LIST

A	B	C	D	E	F					
 2pcs	 1pc	 1pc	 1pc	 2pcs	 8pcs					
G	H	I	J	a	b	c	d	e	f	g
 2pcs	 1pc	 2pcs	 4pcs	 M6*15 8pcs	 13pcs	 M6*40 8pcs	 M6*60 9pcs	 M4 1pc	 4pcs	 13pcs

2

NOTE: PLEASE DO NOT TIGHTEN THE BOLTS UNTIL ALL FIXED

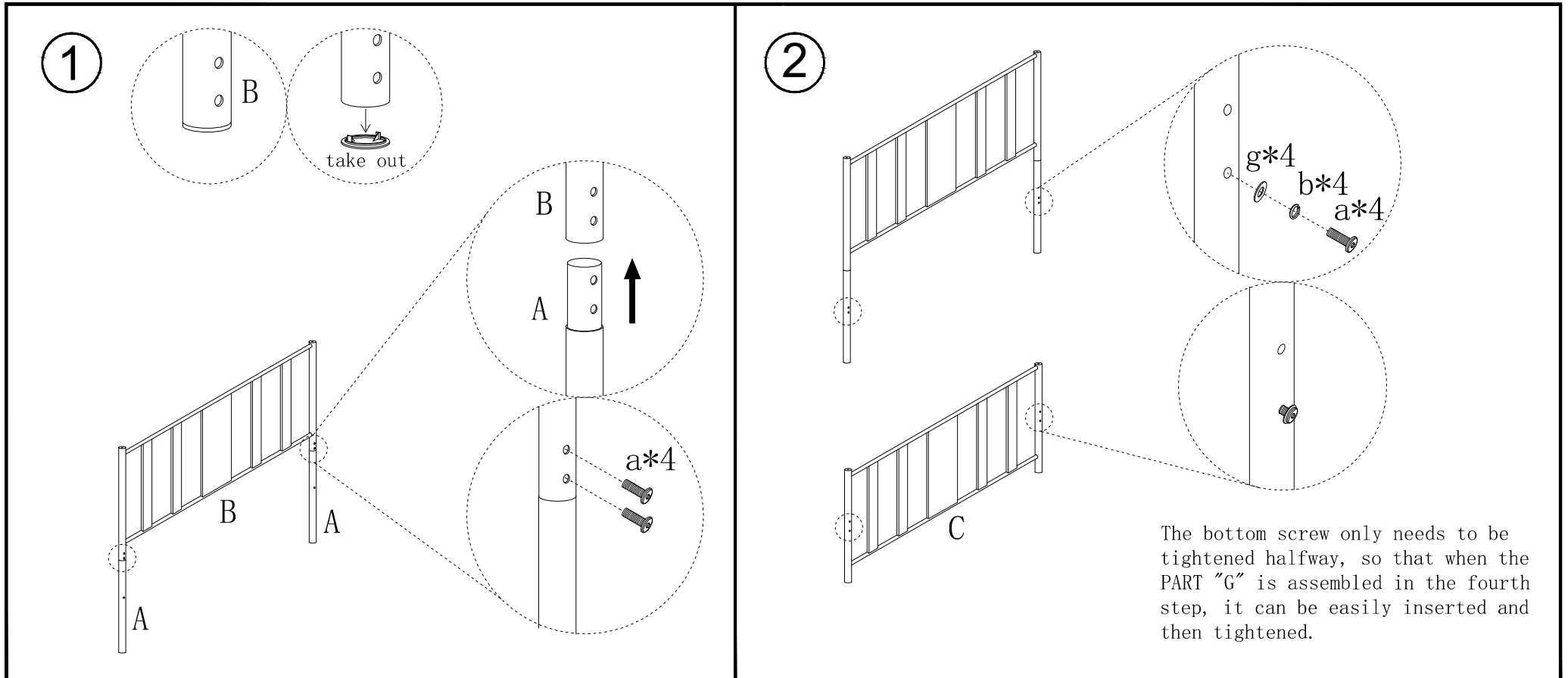

3

3

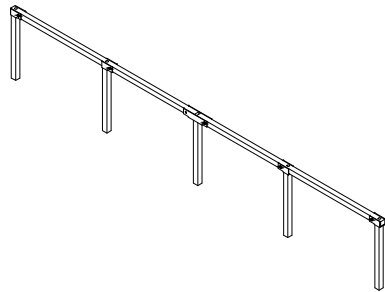
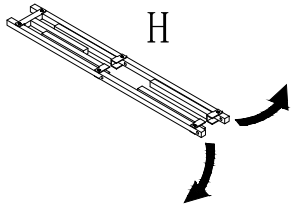
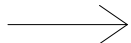
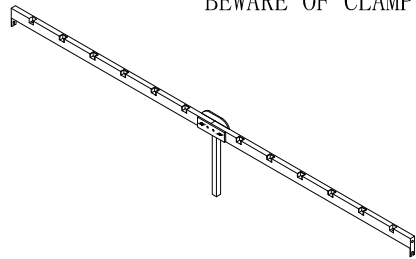
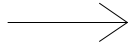
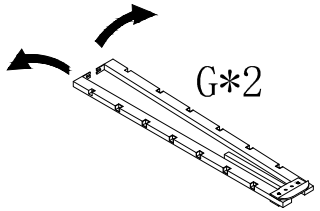

4

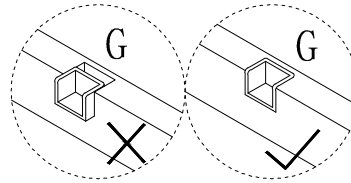

Before assembling the mattress tube, please check whether the plastic clip is fastened on the bed beam, as shown in the picture, please fasten it by hand.

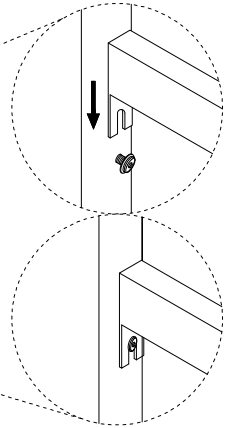
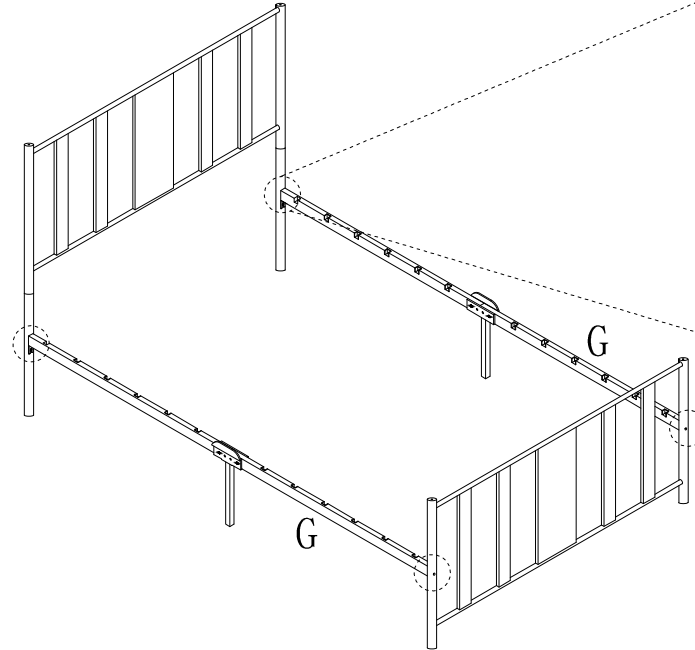

4

5

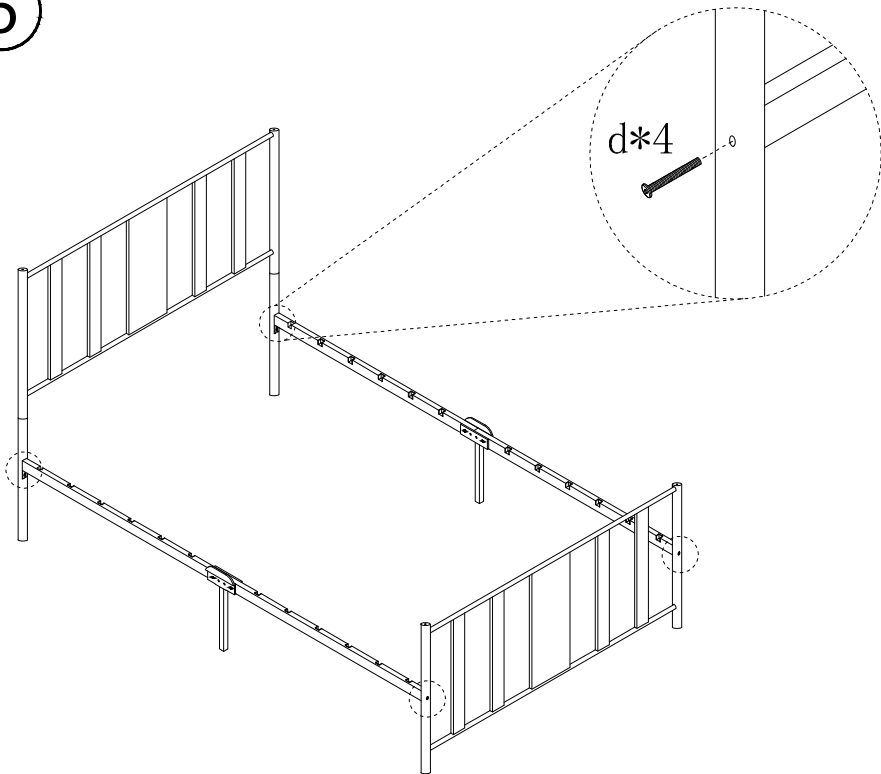

6

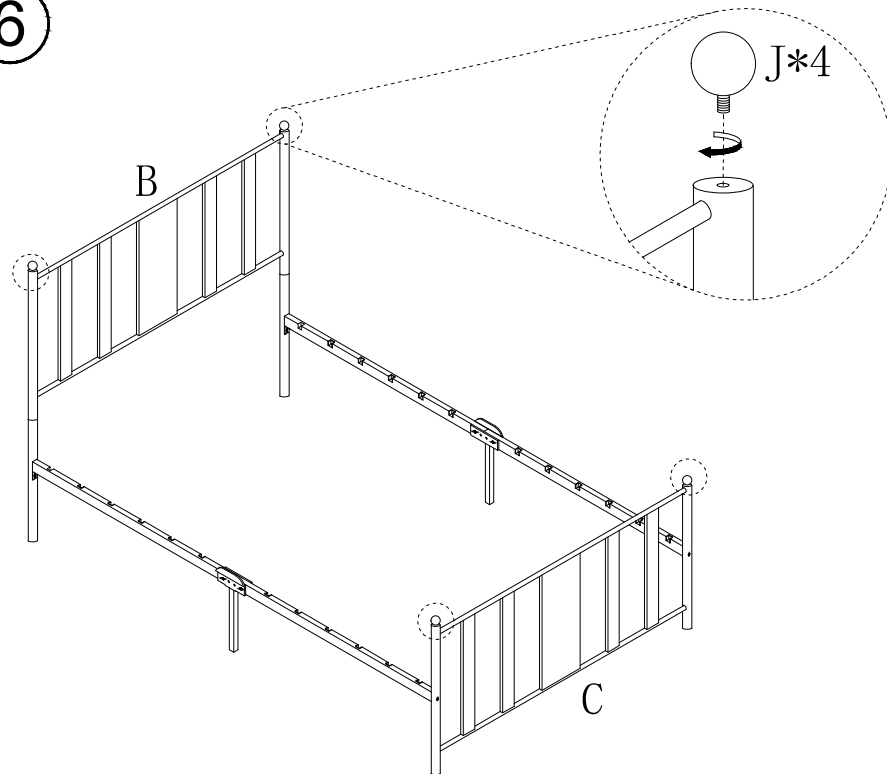

5

7

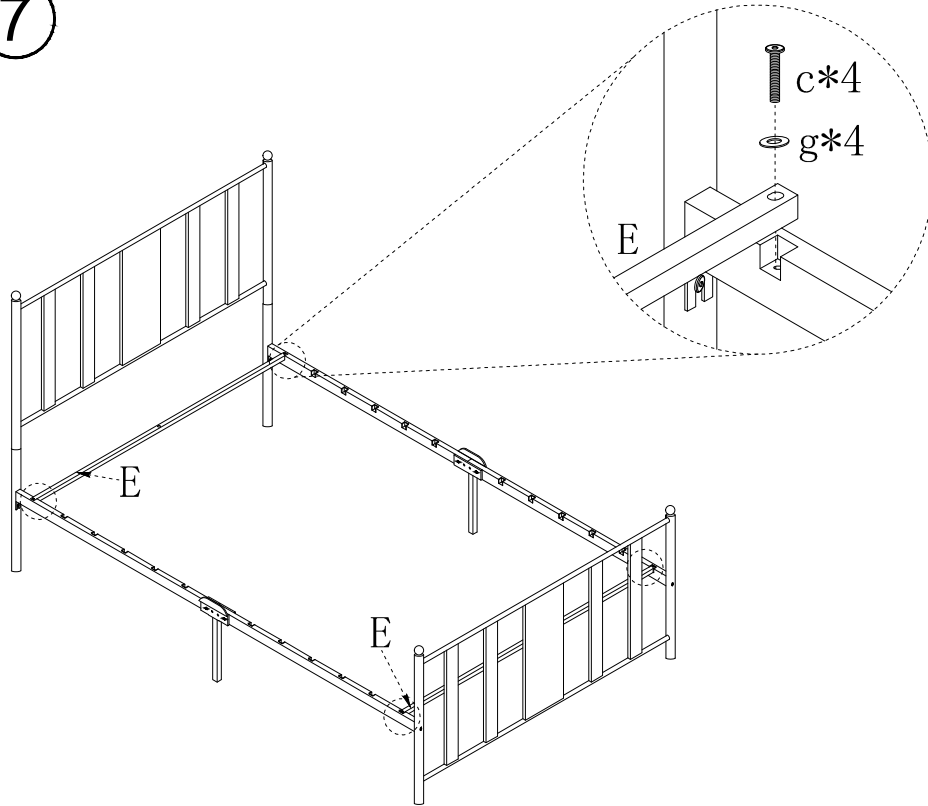

8

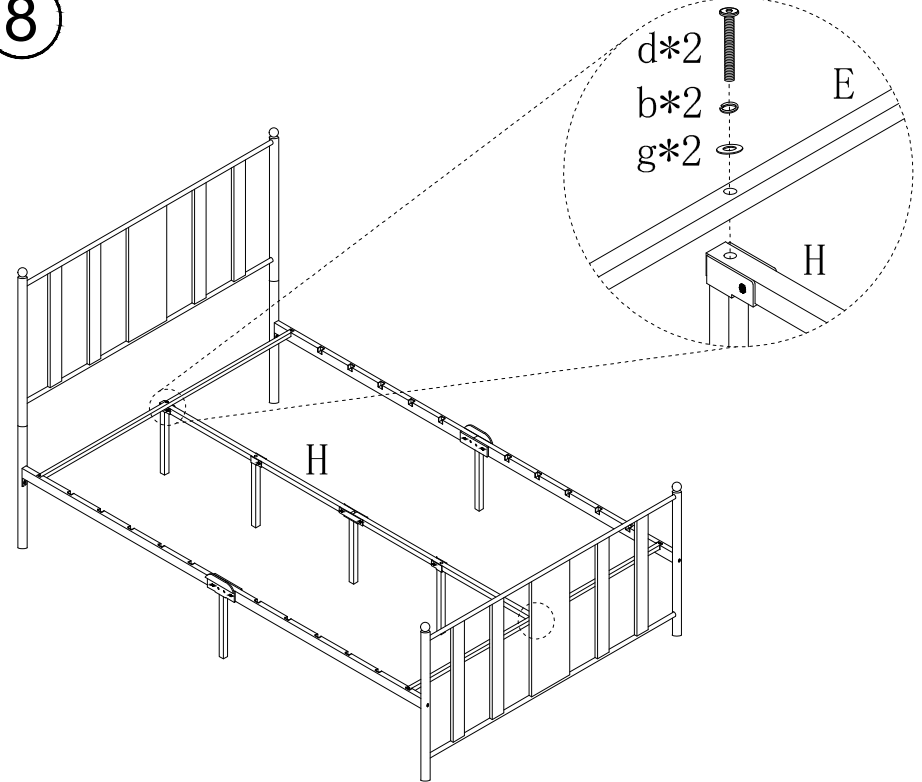

6

9

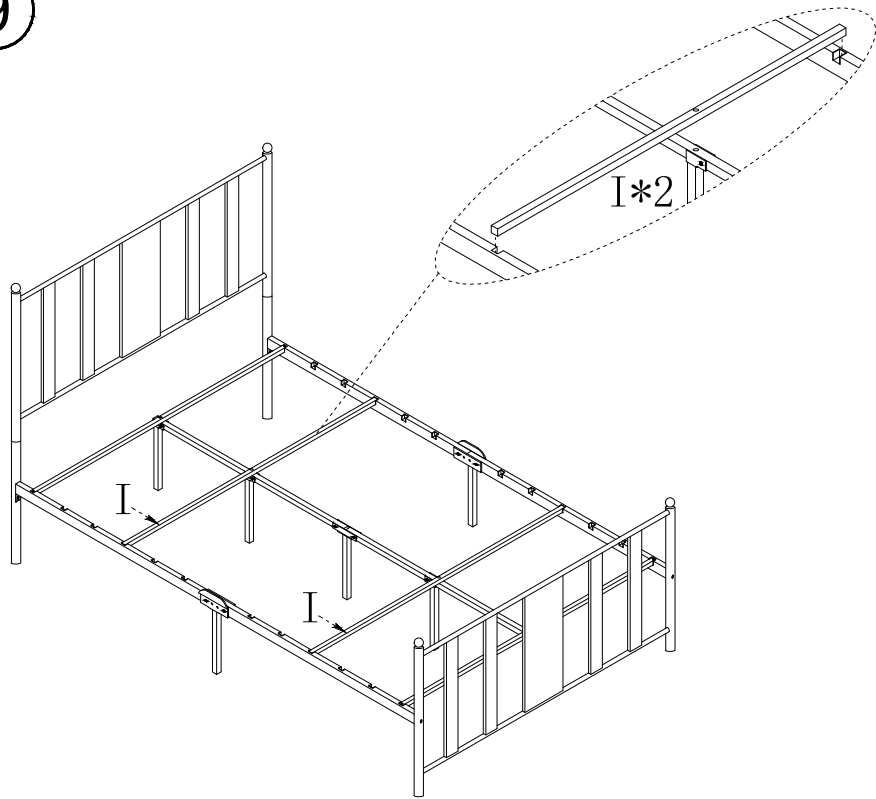

10

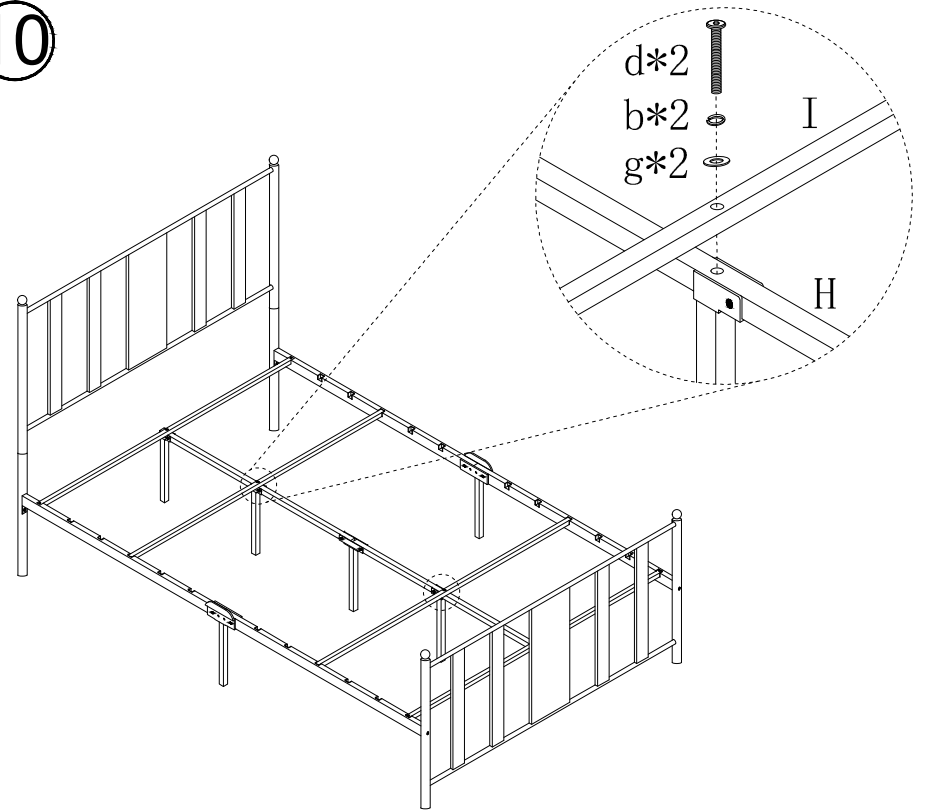

11

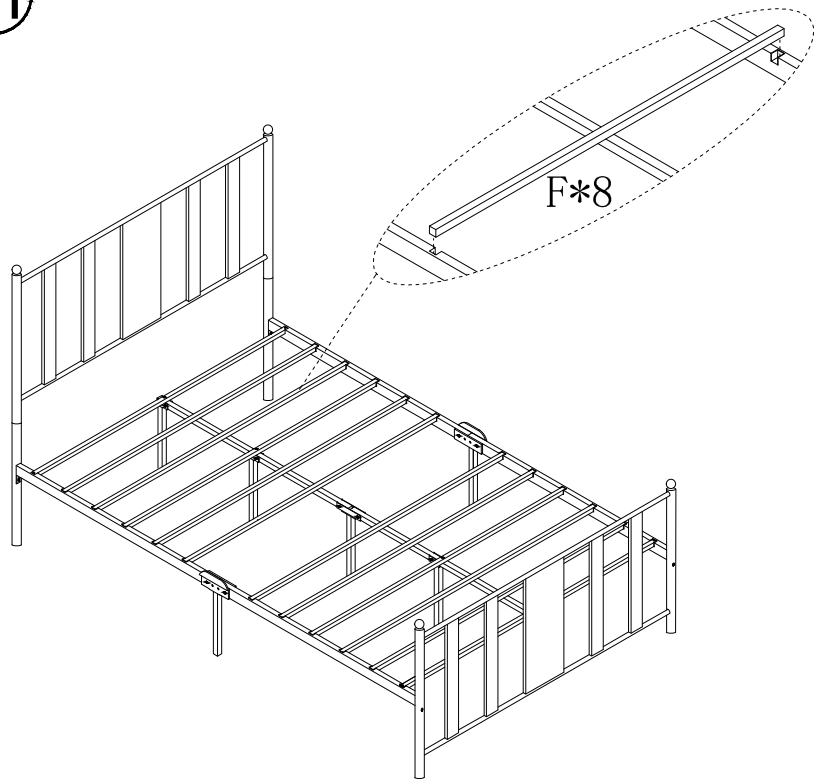

12

