

INSTALLATION

SC001-Oak
JMSC000012

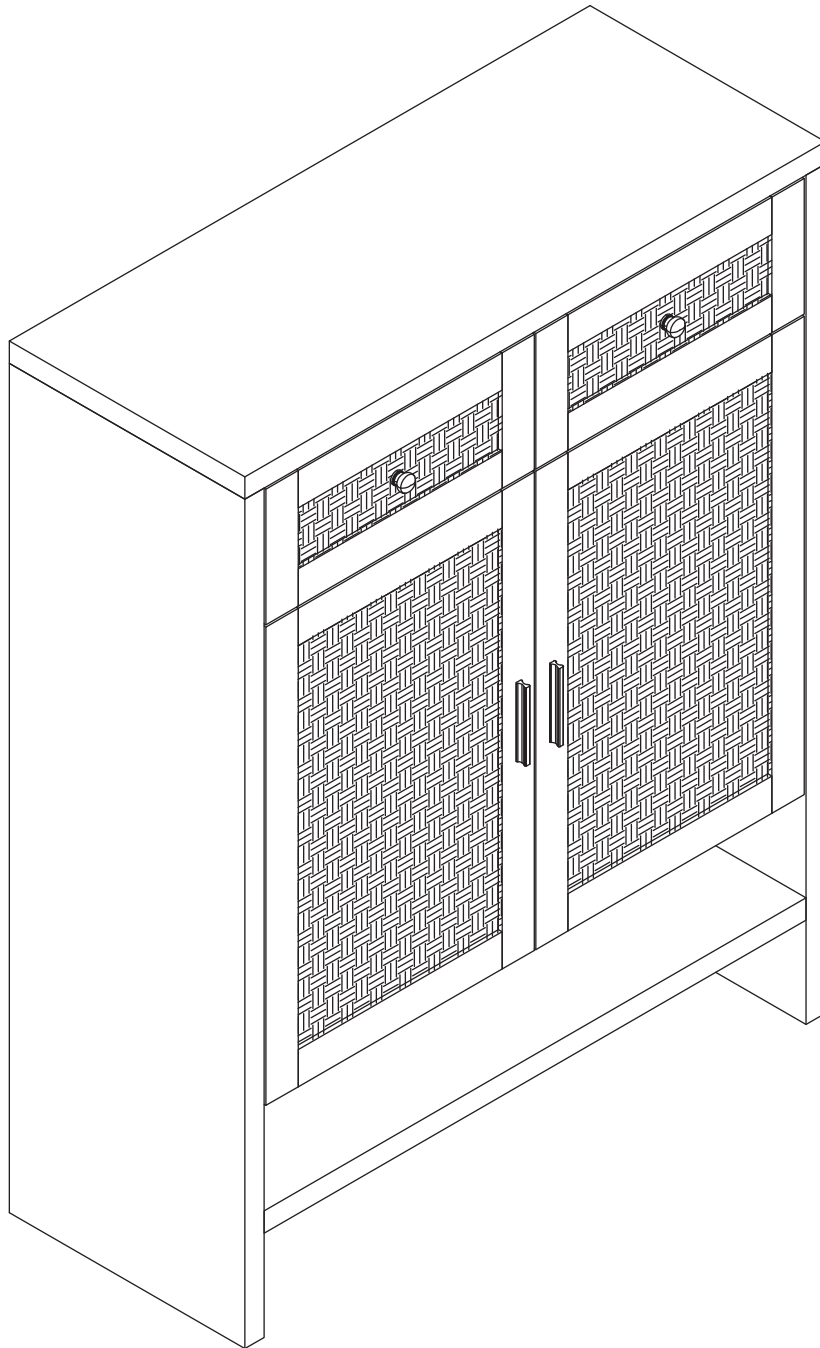

support@Yanosaku.com

NOTICE

IMPORTANT, RETAIN FOR FUTURE REFERENCE: READ CAREFULLY

WICHTIG, FÜR SPÄTERE NACHSCHLAGE AUFBEWAHREN: SORGFÄLTIG LESEN

IMPORTANTE, GUARDAR PARA REFERENCIA FUTURA: LEER ATENTAMENTE

IMPORTANTE, CONSERVARE PER RIFERIMENTI FUTURI: LEGGERE ATTENTAMENTE

IMPORTANT, À CONSERVER POUR RÉFÉRENCE FUTURE : LIRE ATTENTIVEMENT

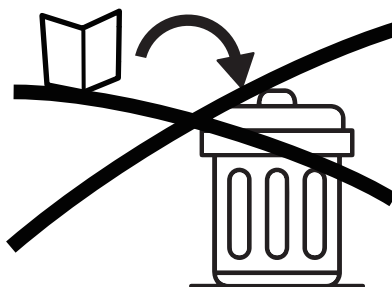
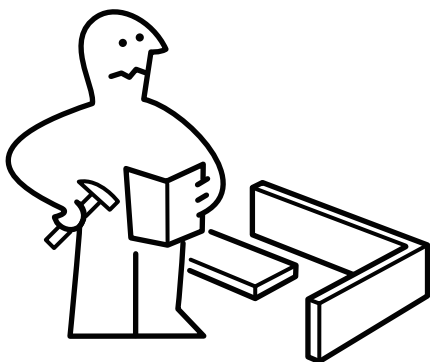

Assemble on a flat, clean and soft surface.

Auf einer flachen, sauberen und weichen Oberfläche zusammenbauen.

Assembler sur une surface plate, propre et douce.

Assemblare su una superficie piatta, pulita e morbida.

Ensamblar sobre una superficie plana, limpia y suave.

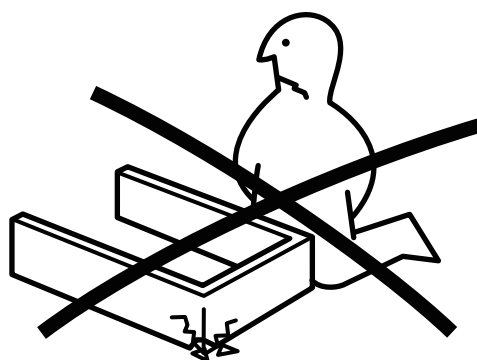
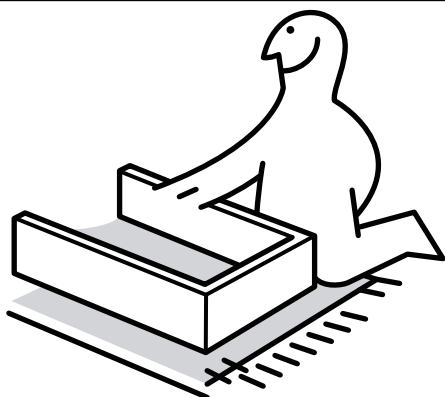

Professional installation is highly recommended.

Eine professionelle Installation wird dringend empfohlen.

Une installation professionnelle est fortement recommandée.

Si raccomanda vivamente l'installazione professionale.

Se recomienda altamente la instalación profesional.



Periodically check that all components are tightly secured.

Überprüfen Sie Regelmäßig, Dass Alle Komponenten Fest Gesichert Sind.

Vérifiez Périodiquement Que Tous Les Composants Sont Bien Fixés.

Controllare Periodicamente Che Tutti I Componenti Siano Ben Fissati.

Verifique Periódicamente Que Todos Los Componentes Estén Bien Asegurados.

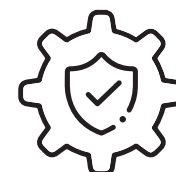

It is recommended that multiple people assemble this product.
 Es wird empfohlen, dass mehrere Personen dieses Produkt zusammenbauen.
 Il est recommandé que plusieurs personnes assemblent ce produit.
 Si raccomanda che più persone assemblino questo prodotto.
 Se recomienda que varias personas ensamblen este producto.

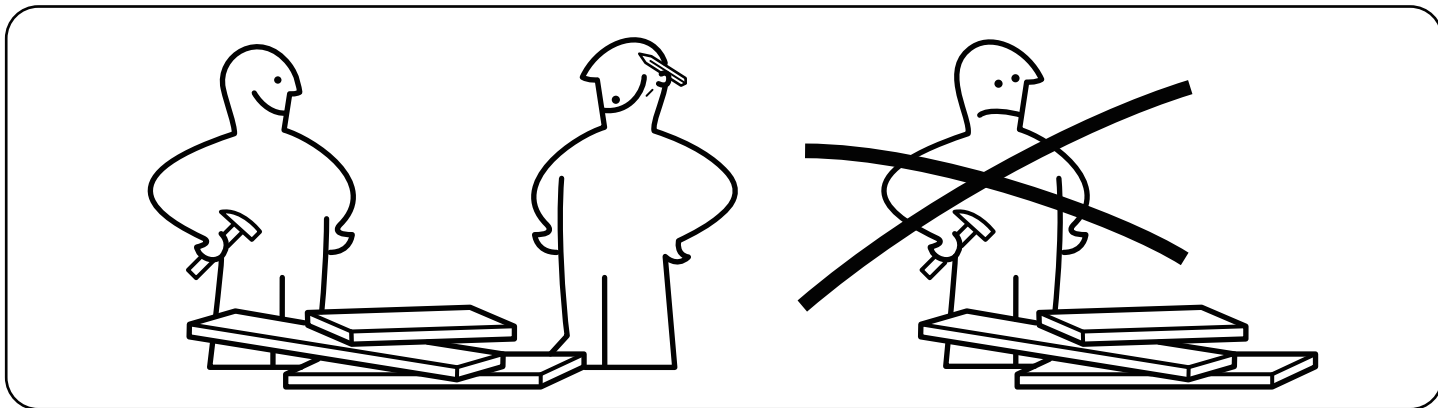

Press And Hold The Drawer Runner Lock And Then Continue To Slide Drawer Runners Apart Before Installation.

Drücken Und Halten Sie Die Schubladenauszugssperre Und Schieben Sie Dann Die Schubladenauszüge Auseinander, Bevor Sie Installieren.

Pressez Et Maintenez Le Verrou Du Coulisseau Du Tiroir, Puis Continuez À Écarter Les Coulisses Du Tiroir Avant L'installation.

Premere E Tenere Premuto Il Blocco Della Guida Del Cassetto, Quindi Continuare A Scorrere Le Guide Del Cassetto Separatamente Prima Dell'installazione.

Presione Y Mantenga Presionado El Bloqueo Del Corredor Del Cajón Y Luego Continúe Deslizandolos Los Corredores Del Cajón Por Separado Antes De La Instalación.

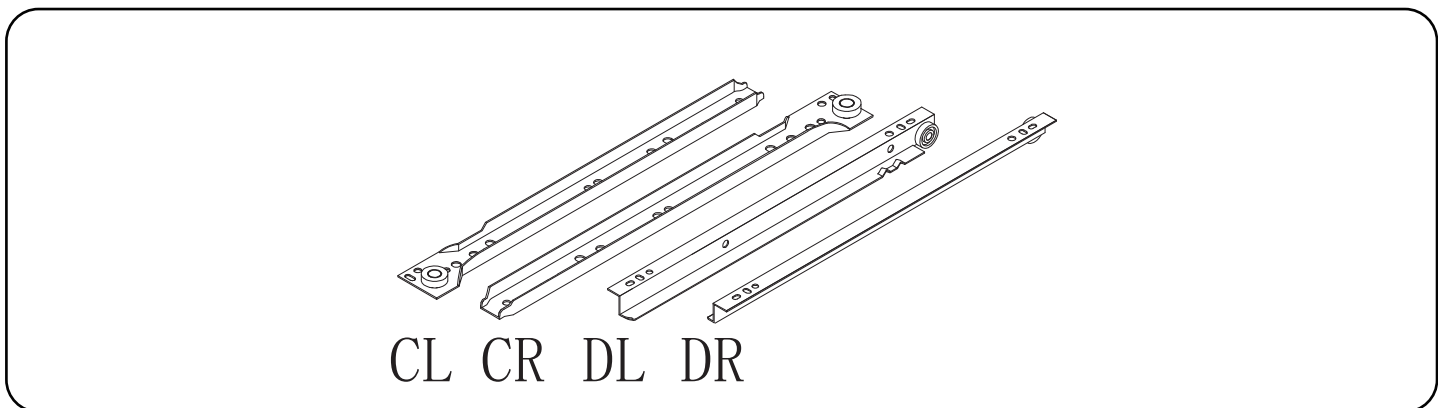

Please have the following auxiliary tools ready:
 Bitte halten Sie folgende Hilfswerkzeuge bereit:
 Veuillez préparer les outils auxiliaires suivants :
 Si prega di avere pronti i seguenti strumenti ausiliari:
 Por favor, tenga listas las siguientes herramientas auxiliares:

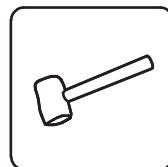

Never let children climb or hang on drawers, doors, or shelves.
 Lassen Sie Kinder niemals auf Schubladen, Türen oder Regalen klettern oder hängen.
 Ne laissez jamais les enfants grimper ou se suspendre aux tiroirs, portes ou étagères.
 Non permettere mai ai bambini di arrampicarsi o appendersi ai cassetti, alle porte o agli scaffali.
 Nunca permita que los niños trepen o se cuelguen de los cajones, puertas o estantes.



Serious or fatal crushing injuries can occur from furniture tip-over. Always secure this furniture to the wall using tip-over restraints.

Schwere oder tödliche Quetschverletzungen können durch das Umkippen von Möbeln verursacht werden. Sichern Sie diese Möbel immer mit Kipp-Sicherungen an der Wand.

Des blessures graves ou mortelles par écrasement peuvent survenir en cas de basculement de meubles. Fixez toujours ces meubles au mur à l'aide de dispositifs anti-basculement.

Lesioni gravi o mortali da schiacciamento possono verificarsi a causa del ribaltamento dei mobili. Fissare sempre questi mobili alla parete utilizzando i sistemi di blocco anti-ribaltamento.

Pueden ocurrir lesiones graves o fatales por aplastamiento debido al volcamiento de muebles. Siempre asegure este mueble a la pared utilizando dispositivos anti-vuelco.

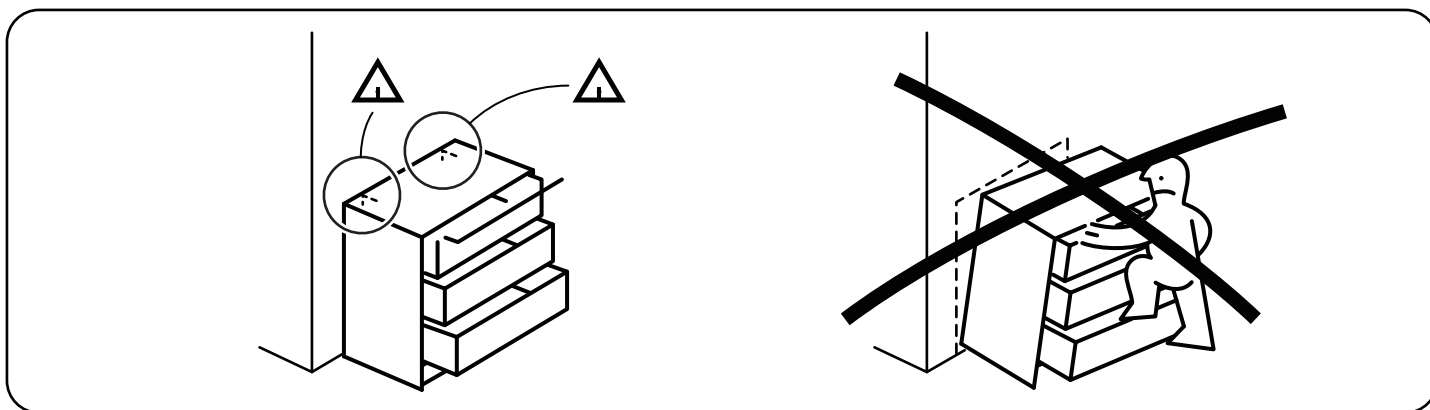

To prevent panel damage during assembly, avoid using power tools and opt for manual tools instead.

Um Schäden an den Paneelen während der Montage zu vermeiden, vermeiden Sie Elektrowerkzeuge und verwenden Sie stattdessen Handwerkzeuge.

Pour éviter d'endommager les panneaux lors de l'assemblage, évitez les outils électriques et utilisez plutôt des outils manuels.

Per prevenire danni ai pannelli durante il montaggio, evita gli utensili elettrici e usa invece utensili manuali.

Para prevenir daños en los paneles durante el montaje, evite herramientas eléctricas y use herramientas manuales en su lugar.

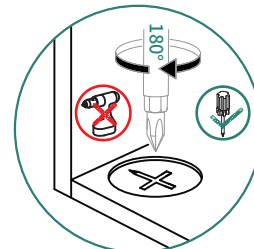
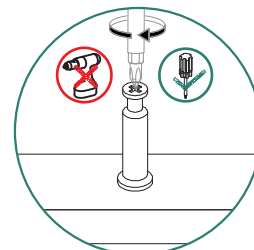



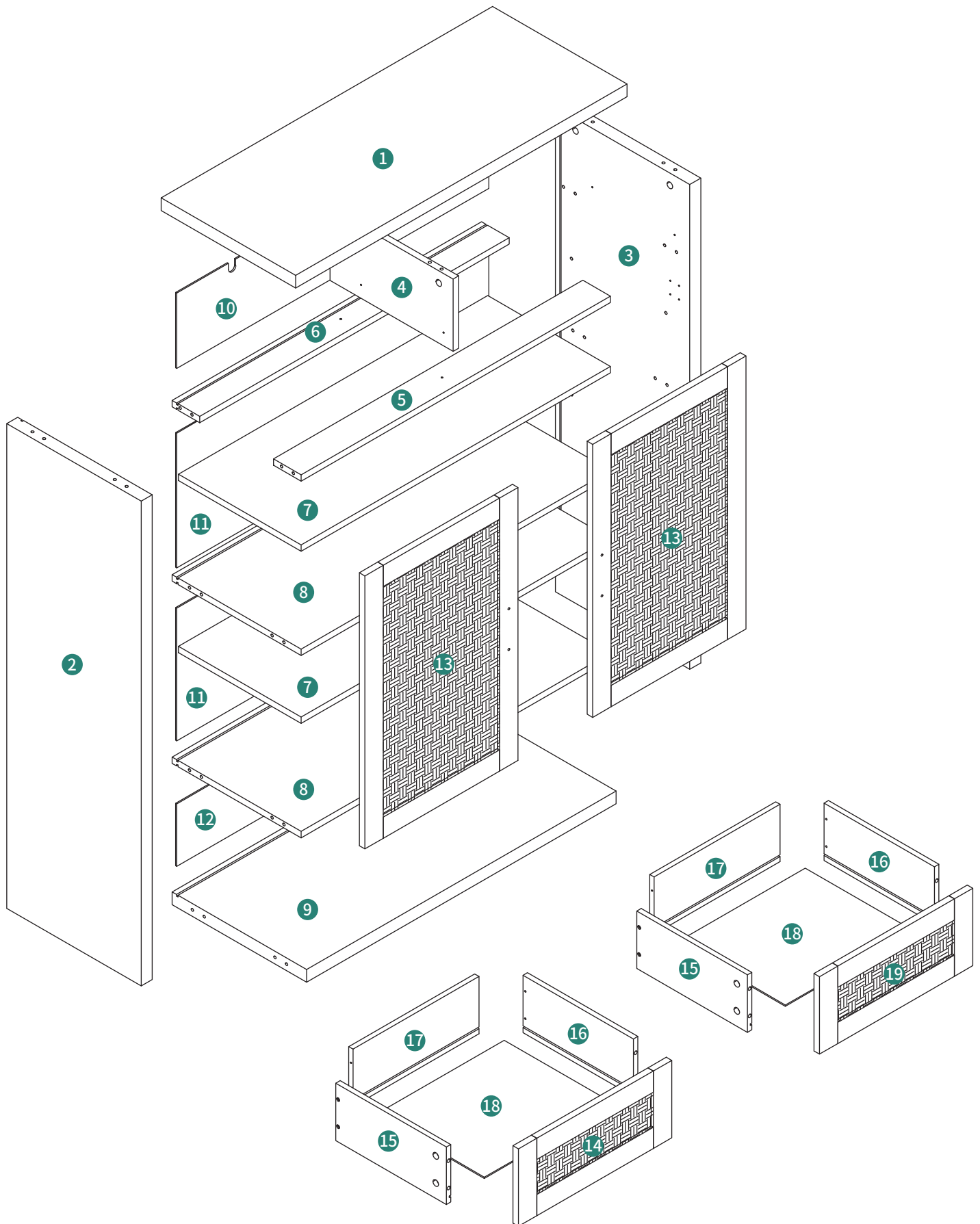

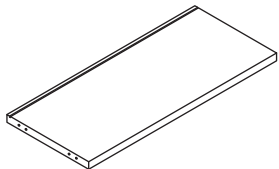
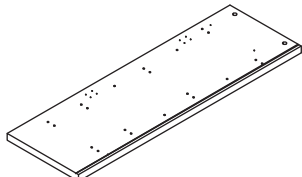
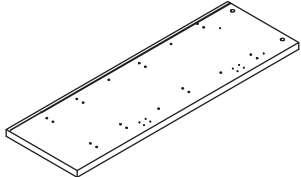
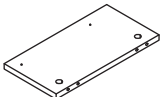
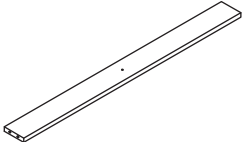
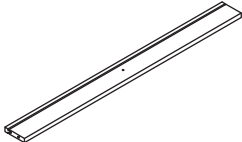
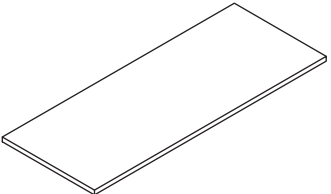
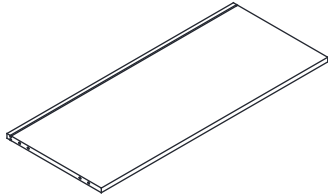
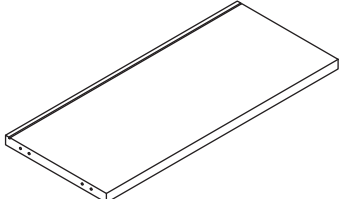
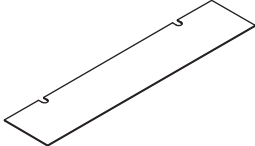
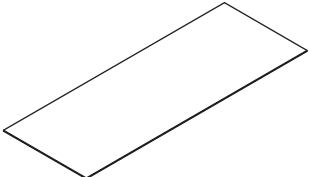
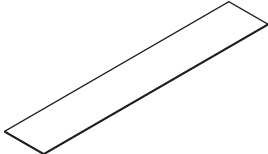
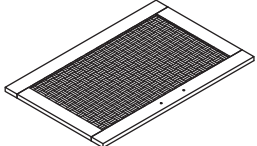
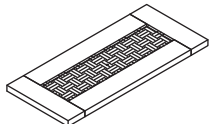
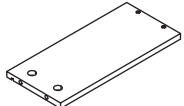
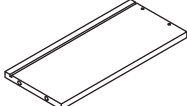

EXPLODED VIEW

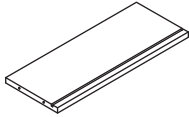
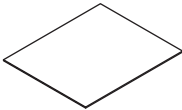
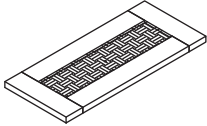
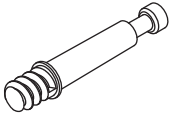

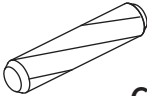
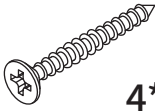
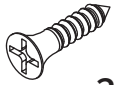
PARTS

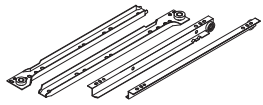
Item no. Nr. N° d'article Articolo No. Artículo No.	Reference Image Referenzbild Image de référence Immagine di riferimento Imagen de referencia	Qty. Menge Qté. Qtà Cant.	Item no. Nr. N° d'article Articolo No. Artículo No.	Reference Image Referenzbild Image de référence Immagine di riferimento Imagen de referencia	Qty. Menge Qté. Qtà Cant.
1		X1	2		X1
3		X1	4		X1
5		X1	6		X1
7		X2	8		X2
9		X1	10		X1
11		X2	12		X1
13		X2	14		X1
15		X2	16		X2

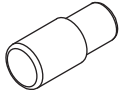
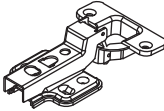
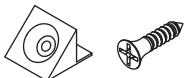
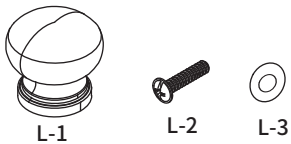
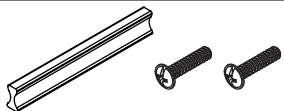
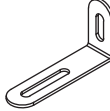
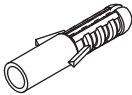
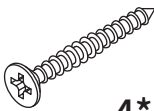
Item no. Nr. N° d'article Articolo No. Artículo No.	Reference Image Referenzbild Image de référence Immagine di riferimento Imagen de referencia	Qty. Menge Qté. Qtà Cant.	Item no. Nr. N° d'article Articolo No. Artículo No.	Reference Image Referenzbild Image de référence Immagine di riferimento Imagen de referencia	Qty. Menge Qté. Qtà Cant.
17		X2	18		X2
19		X1			
A		X30+3	B		X30+3
C	 6*30MM	X22+2	D	 4*40MM	X4
E	 3.5*12MM	X16+1	F	 4*14MM	X2
G	 CL CR DL DR	X2	H	 3.5*14MM	X24+2
I		X8	J		X4
K		X12	L	 L-1 L-2 L-3	X2
M		X2	N		X2
O		X2	P	 4*30MM	X8

ASSEMBLY

1

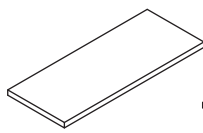

① 1pc

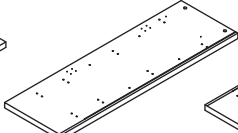

② 1pc

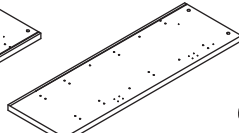

③ 1pc

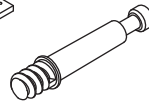

A 22pcs

ST3X12mm

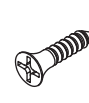

E 4pcs

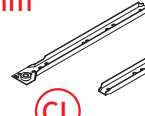

CL

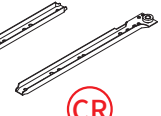

CR

G 1pc

ST4X14mm



F 2pcs

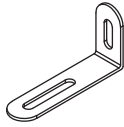

N 2pcs

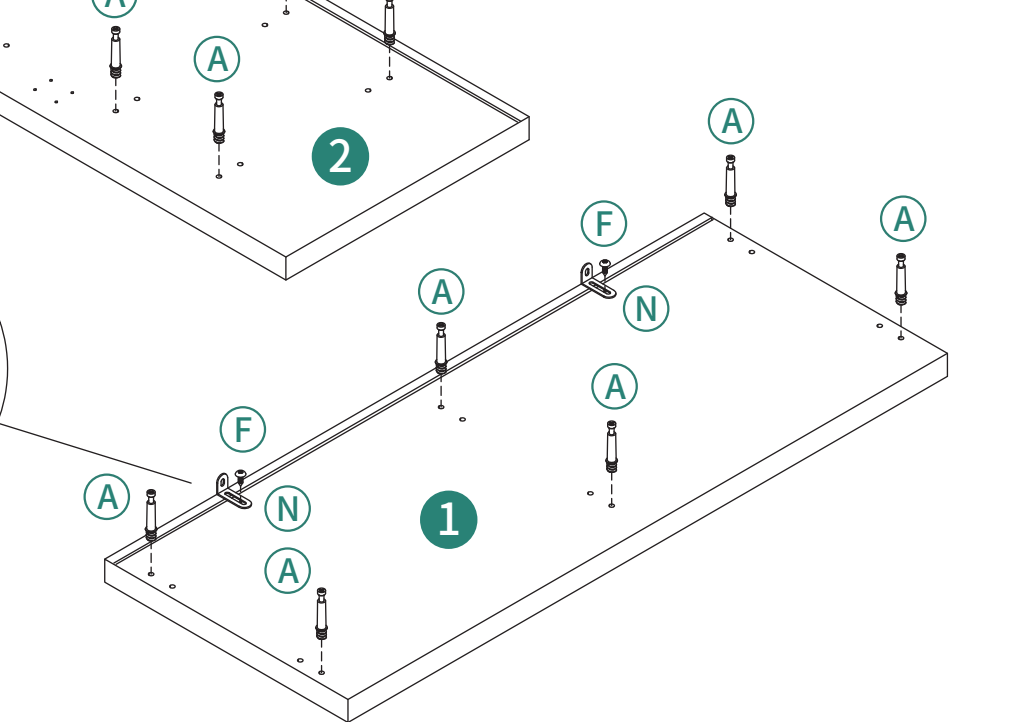
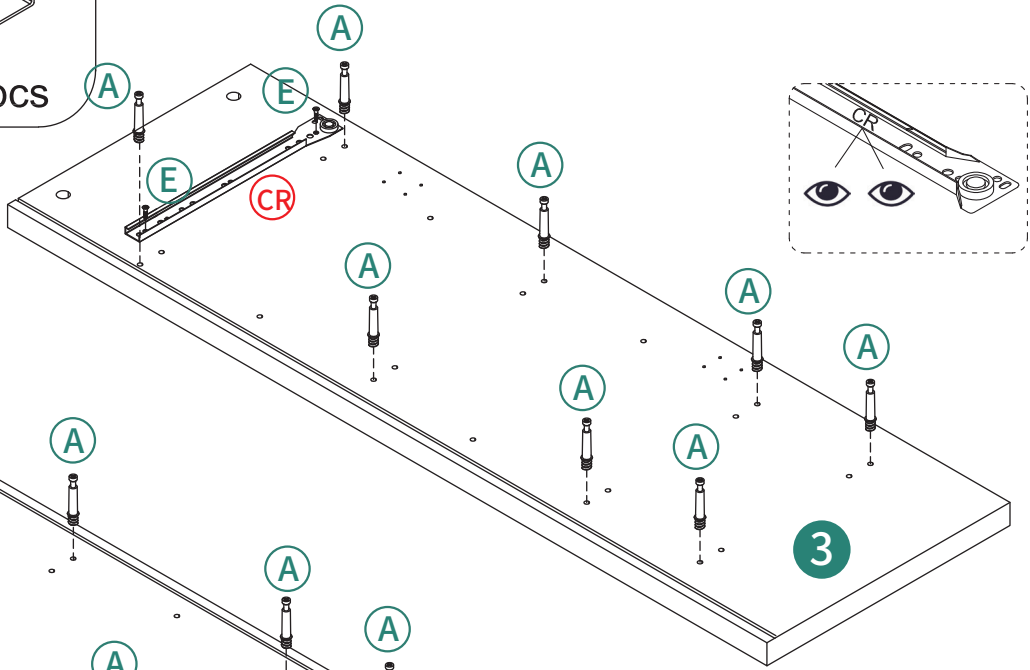
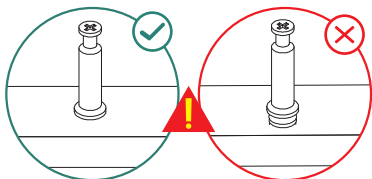
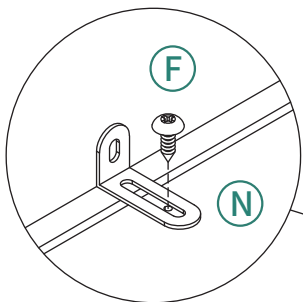
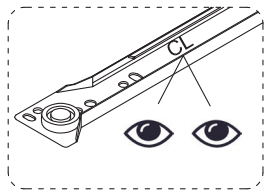
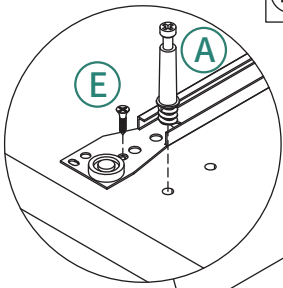

ASSEMBLY

2

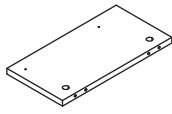

④ 1pc

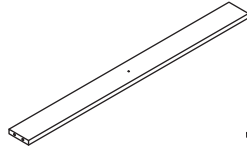

⑤ 1pc

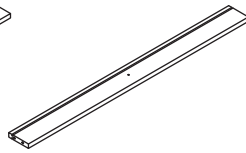

⑥ 1pc



ⓓ 2pcs



ⓔ 4pcs

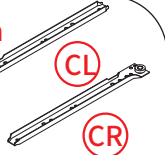

ⓐ

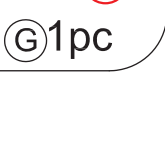

ⓑ

ⓖ 1pc

180°

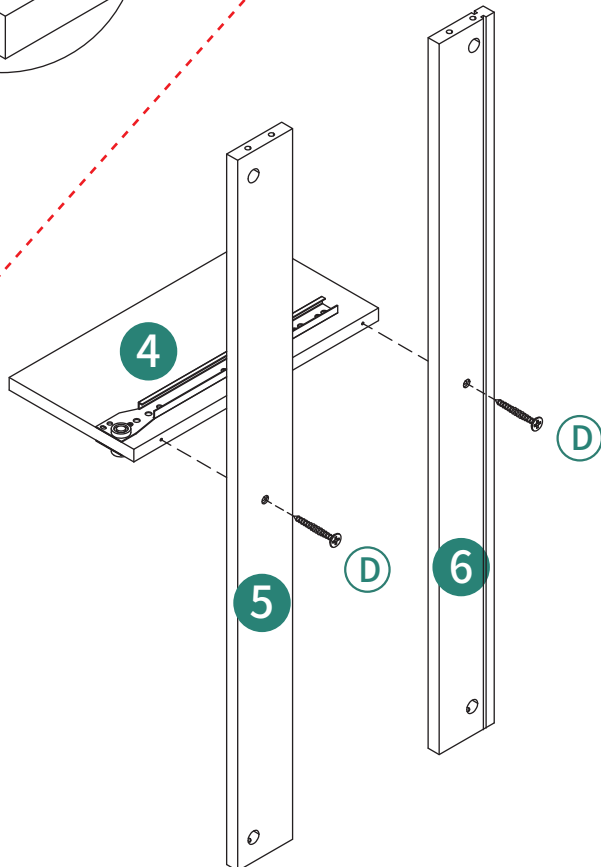
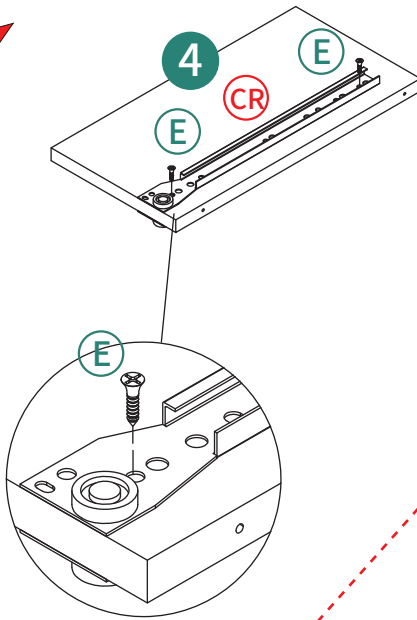
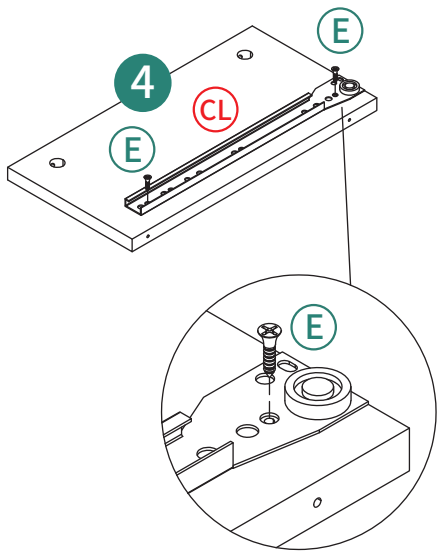

ASSEMBLY

3

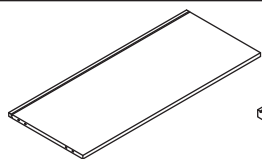

⑧ 2pcs

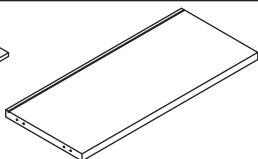

⑨ 1pc

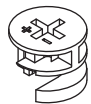

Ⓑ 8pcs



Ⓒ 8pcs

ST6X30mm

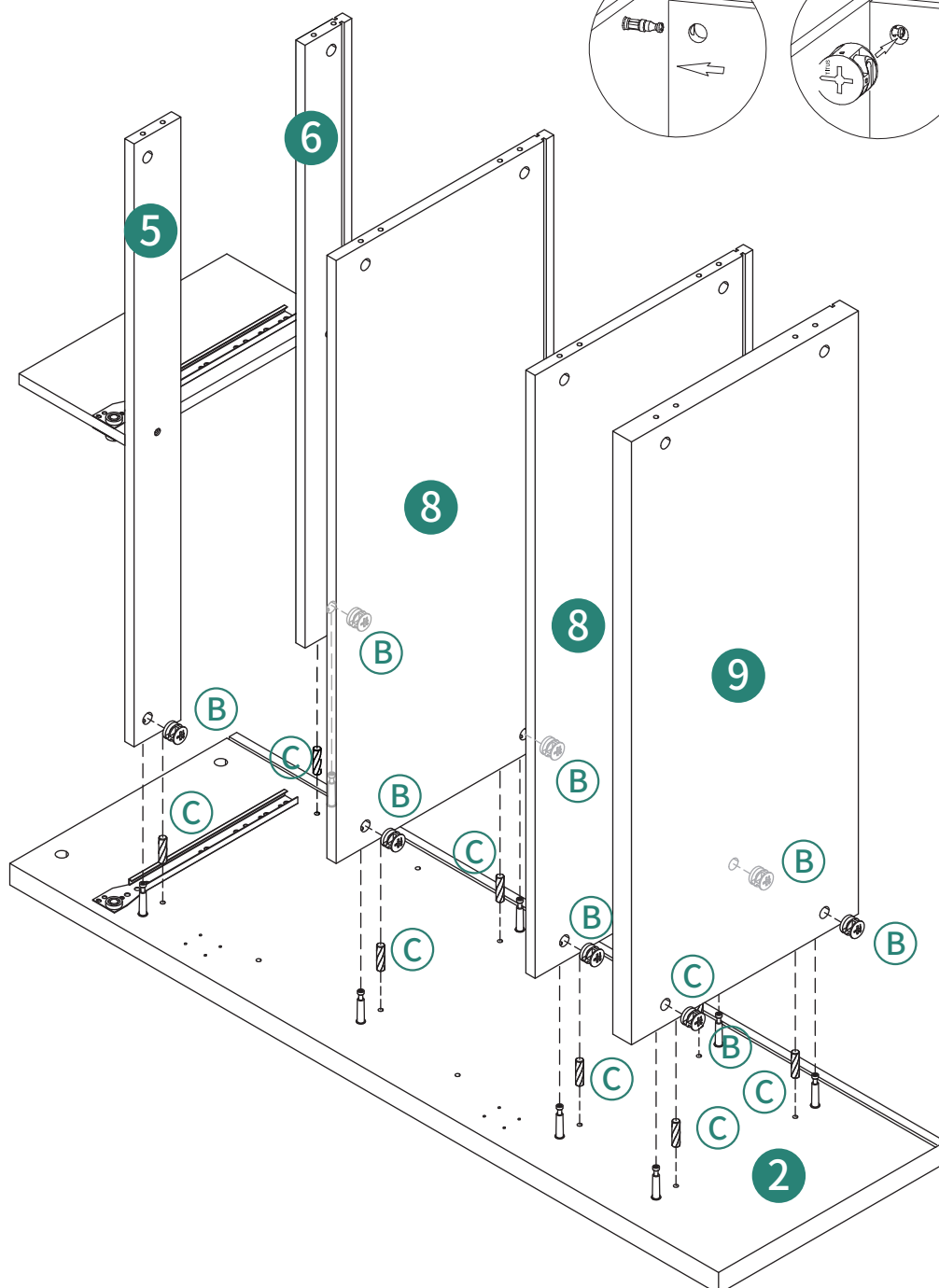
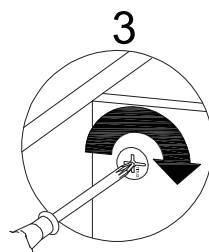
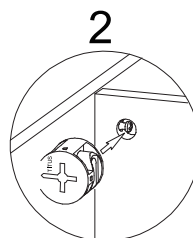
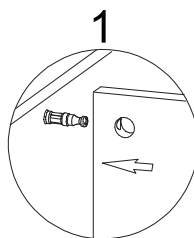

ASSEMBLY

4

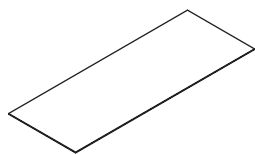

①1 2pcs

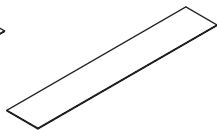

①2 1pc

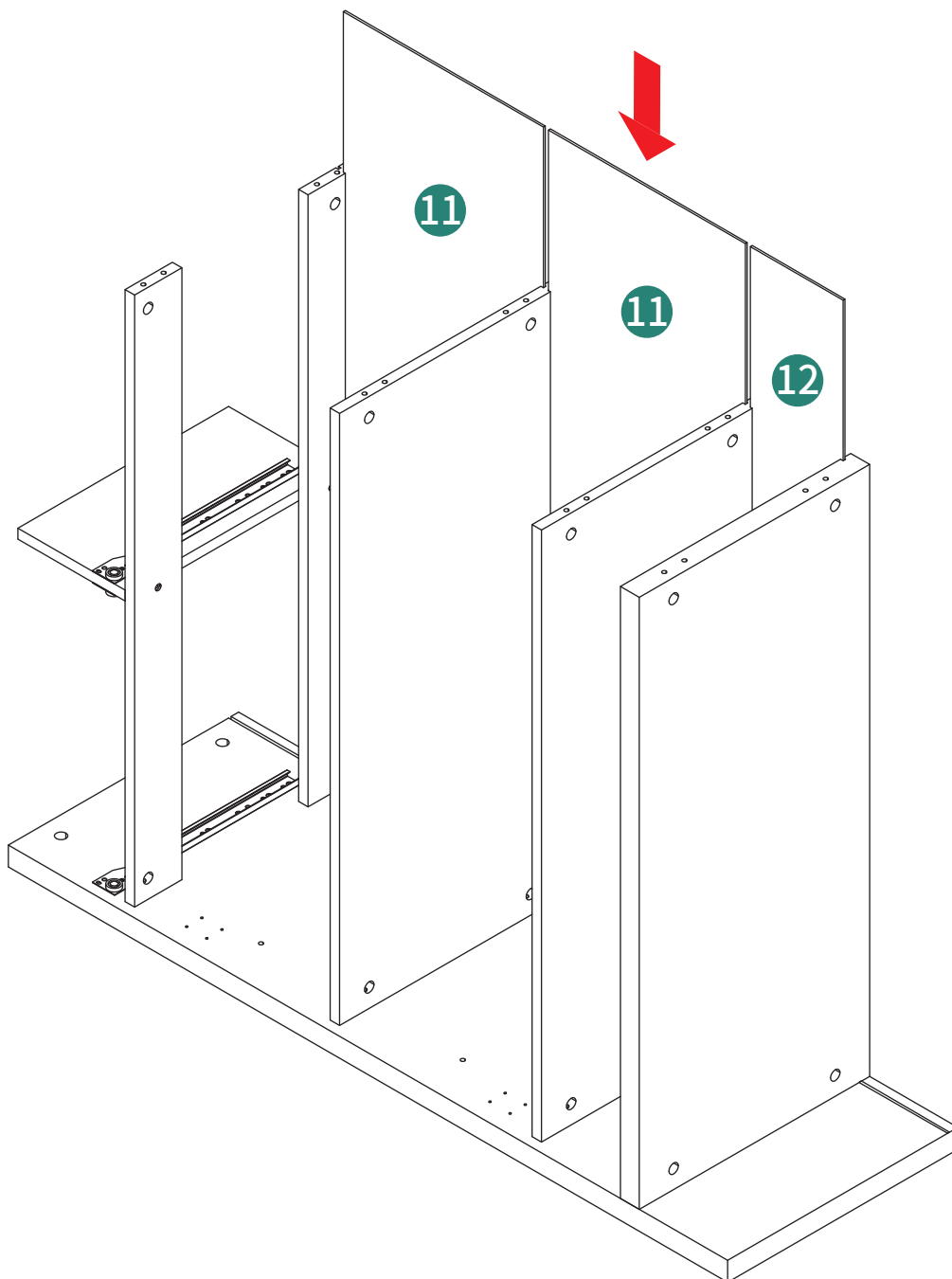

ASSEMBLY

5

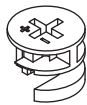

(B) 8pcs

ST6X30mm



(C) 8pcs

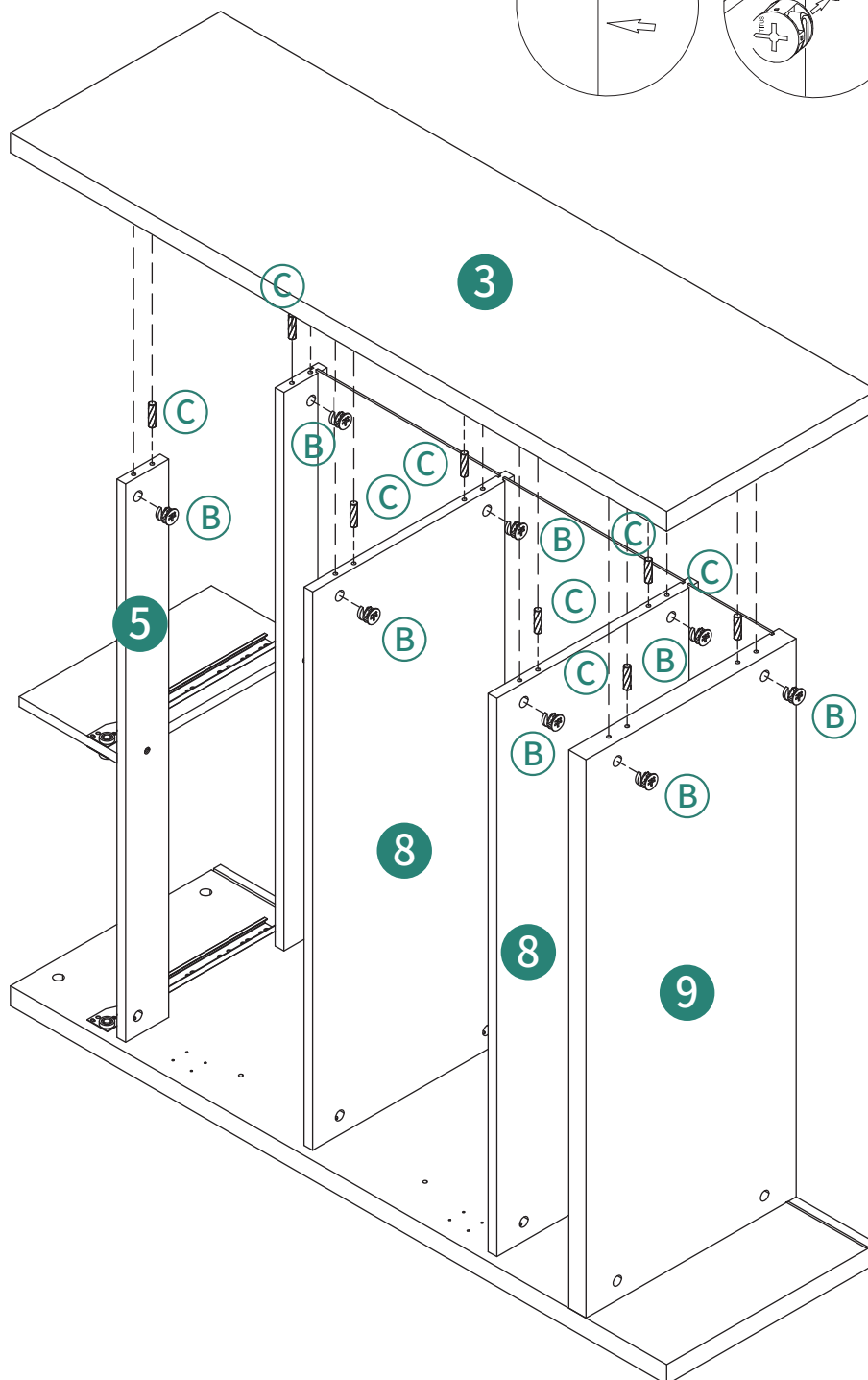
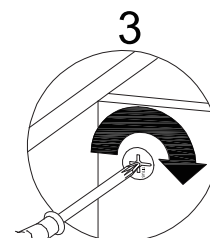
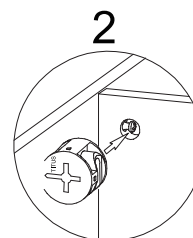
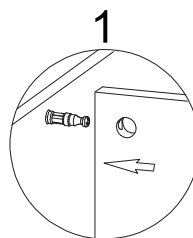

ASSEMBLY

7

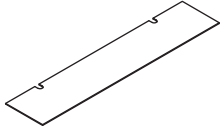

⑩1pc

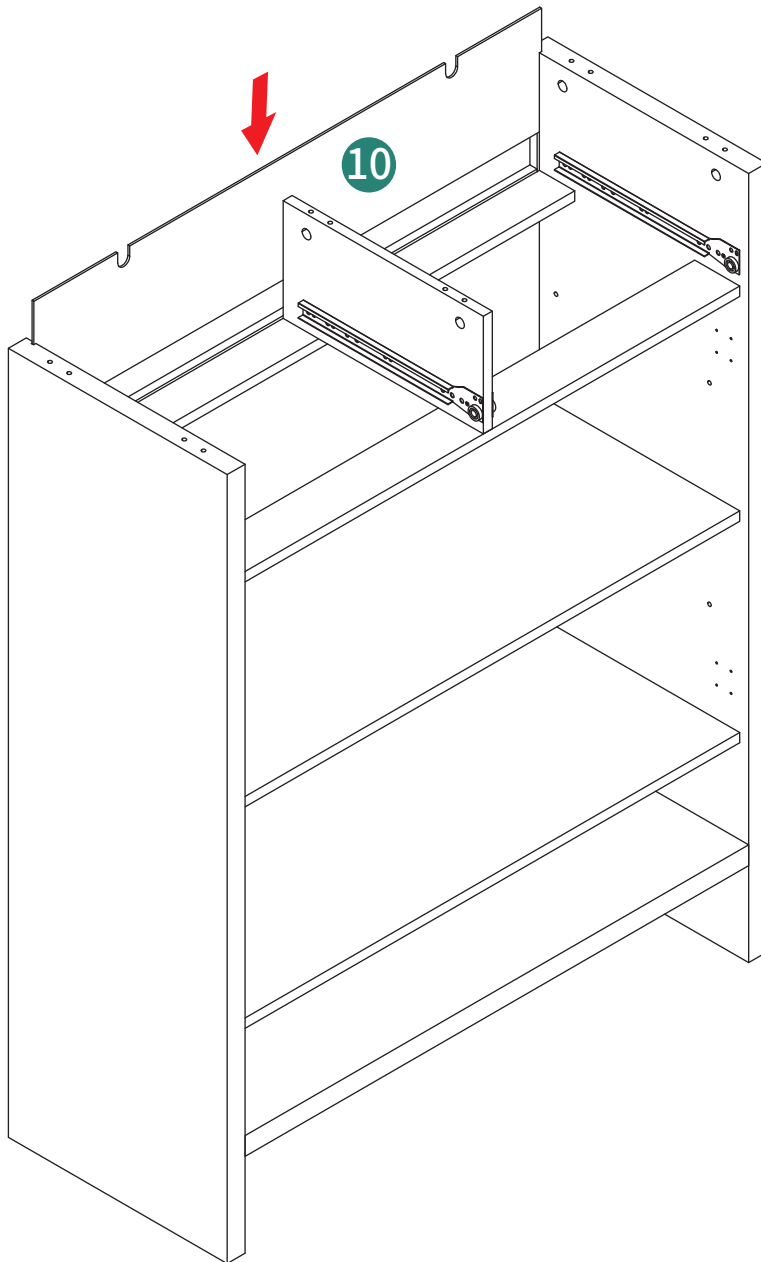

ASSEMBLY

8

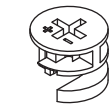

(B) 6pcs

ST6X30mm



(C) 6pcs

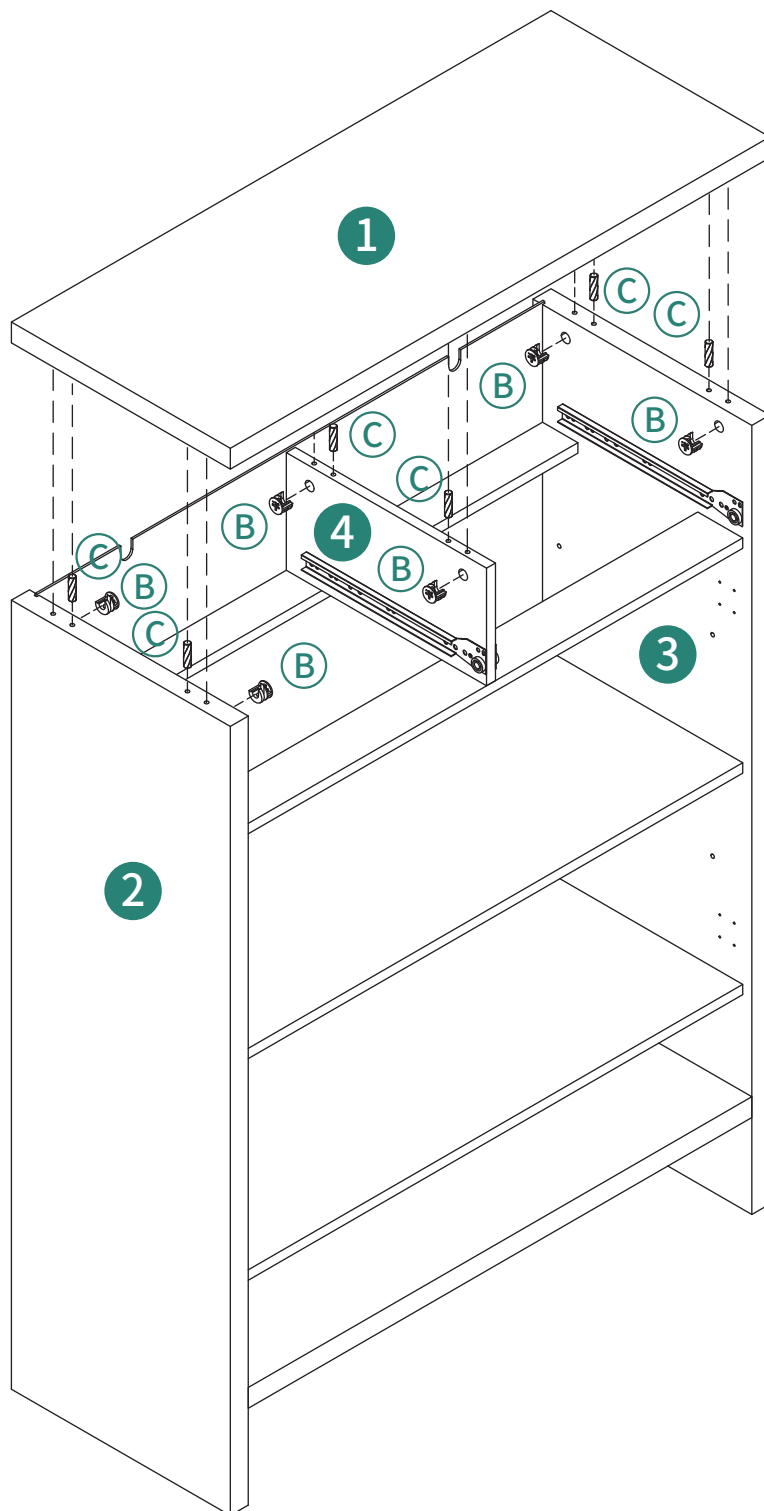
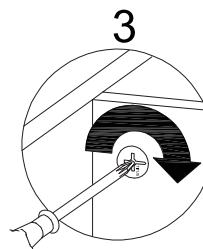
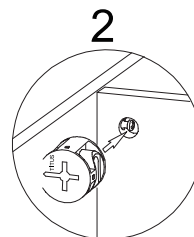
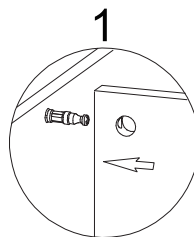

ASSEMBLY

9

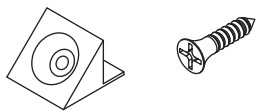

(K) 12 pcs

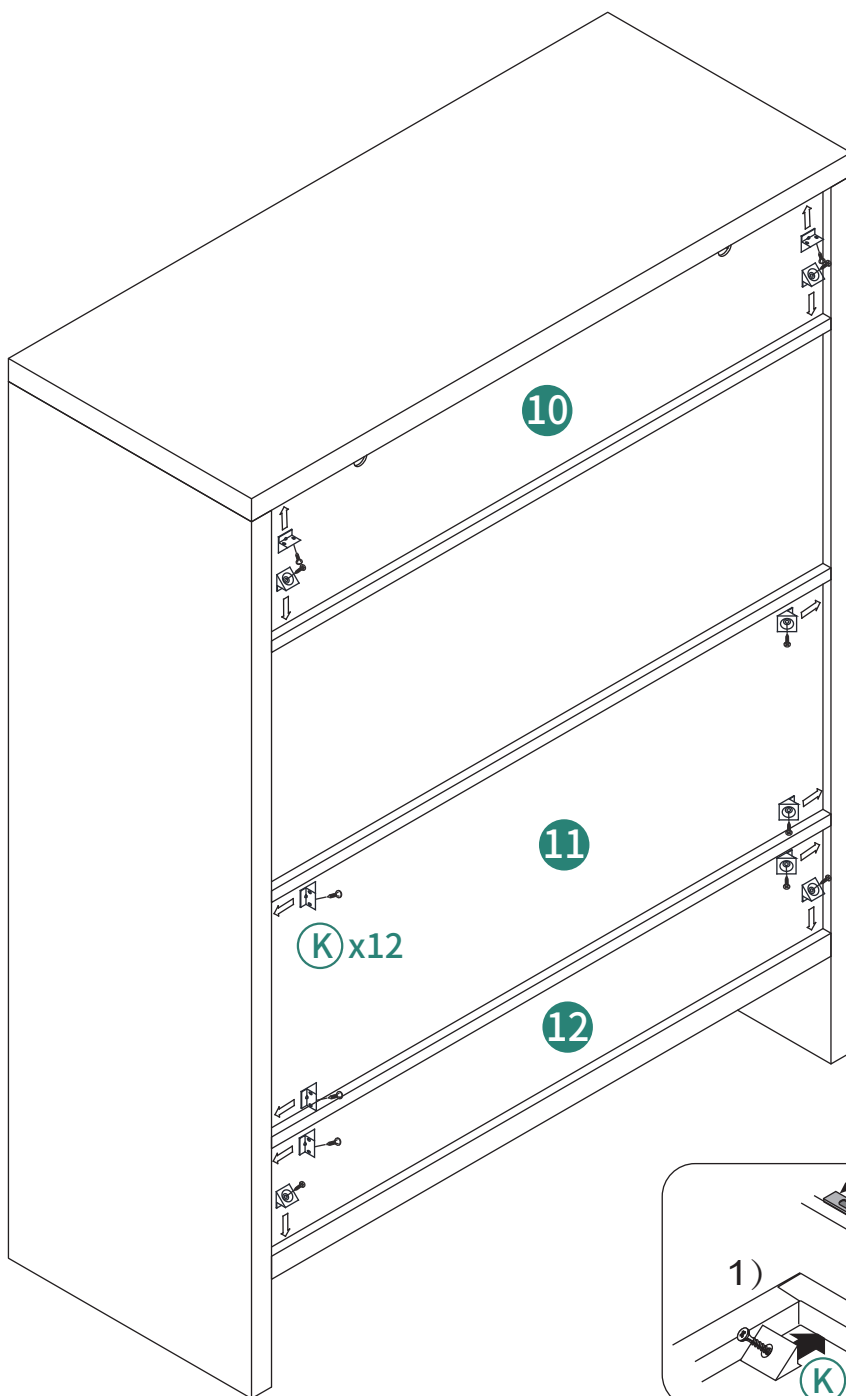

ASSEMBLY

10

ST4X40mm

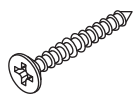

(D) 2pcs

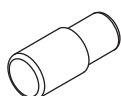

(I) 8pcs

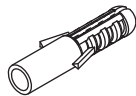

(O) 2pcs

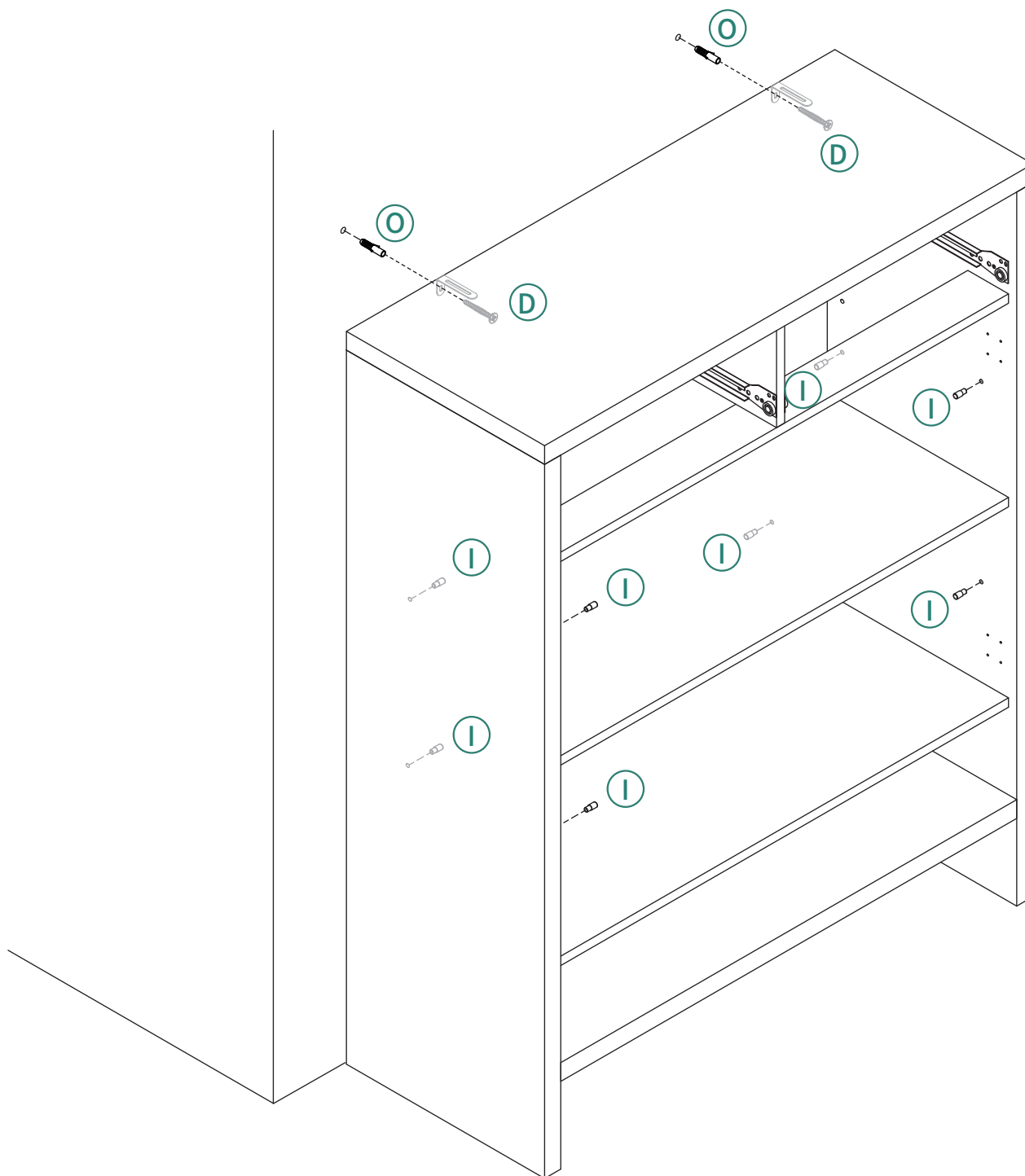
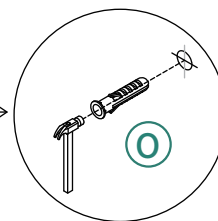
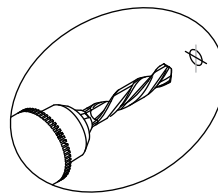

ASSEMBLY

11

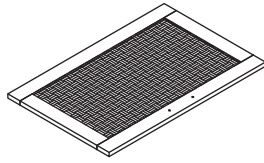

13 2pcs

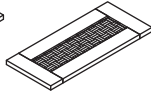

14 1pc

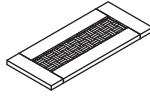

19 1pc

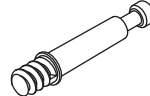

A 8pcs

ST3.5X14mm



H 8pcs

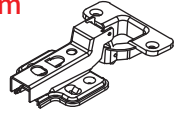

J 4pcs

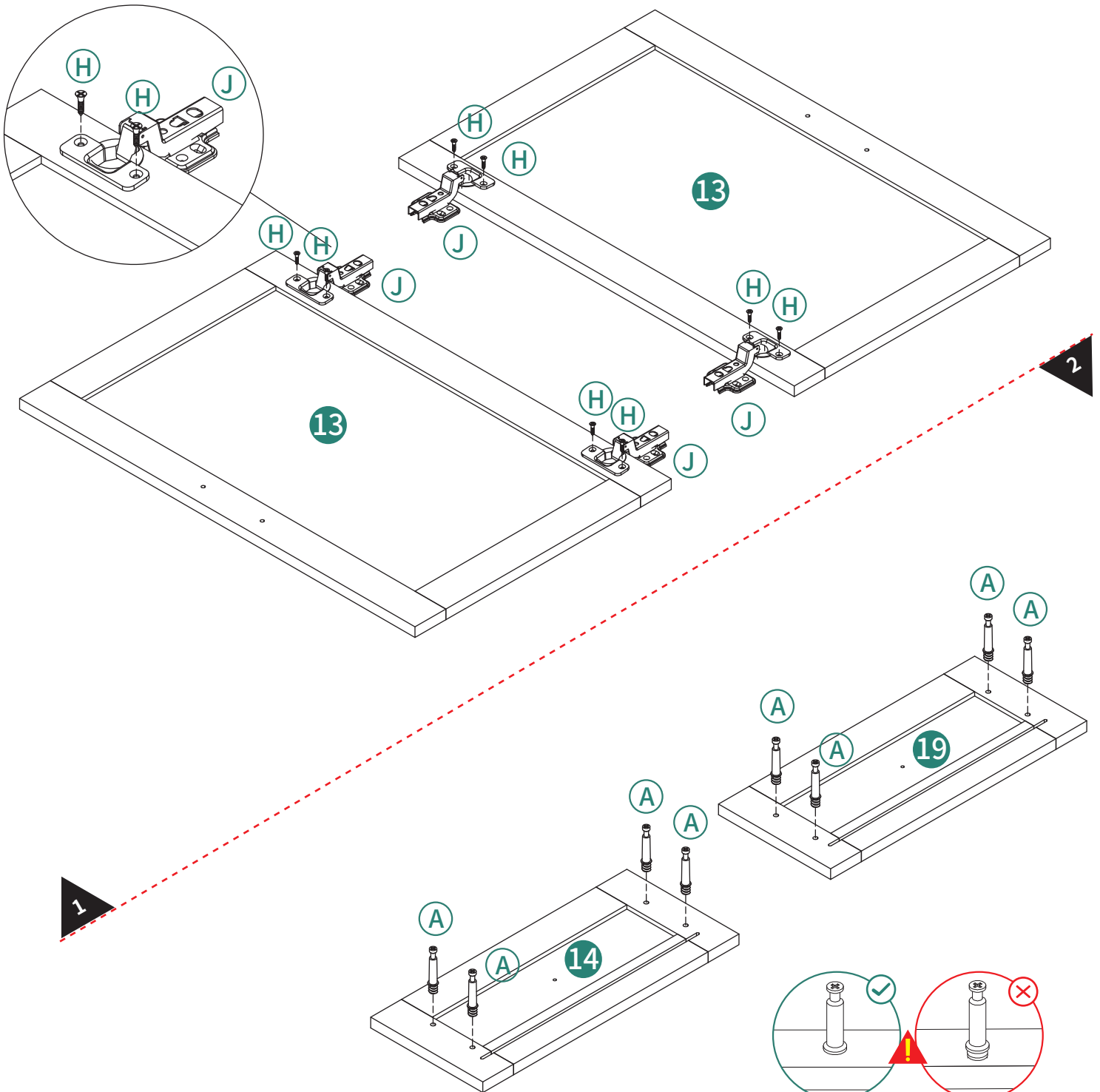

16

ASSEMBLY

12
X2

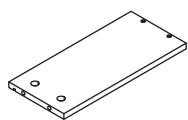

⑮ 2pcs

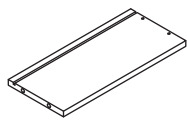

⑯ 2pcs

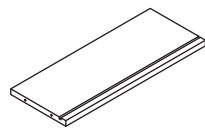

⑰ 2pcs

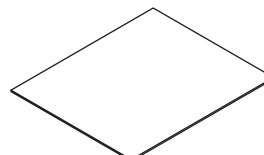

⑱ 2pcs

ST4X30mm

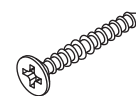

Ⓟ 8pcs

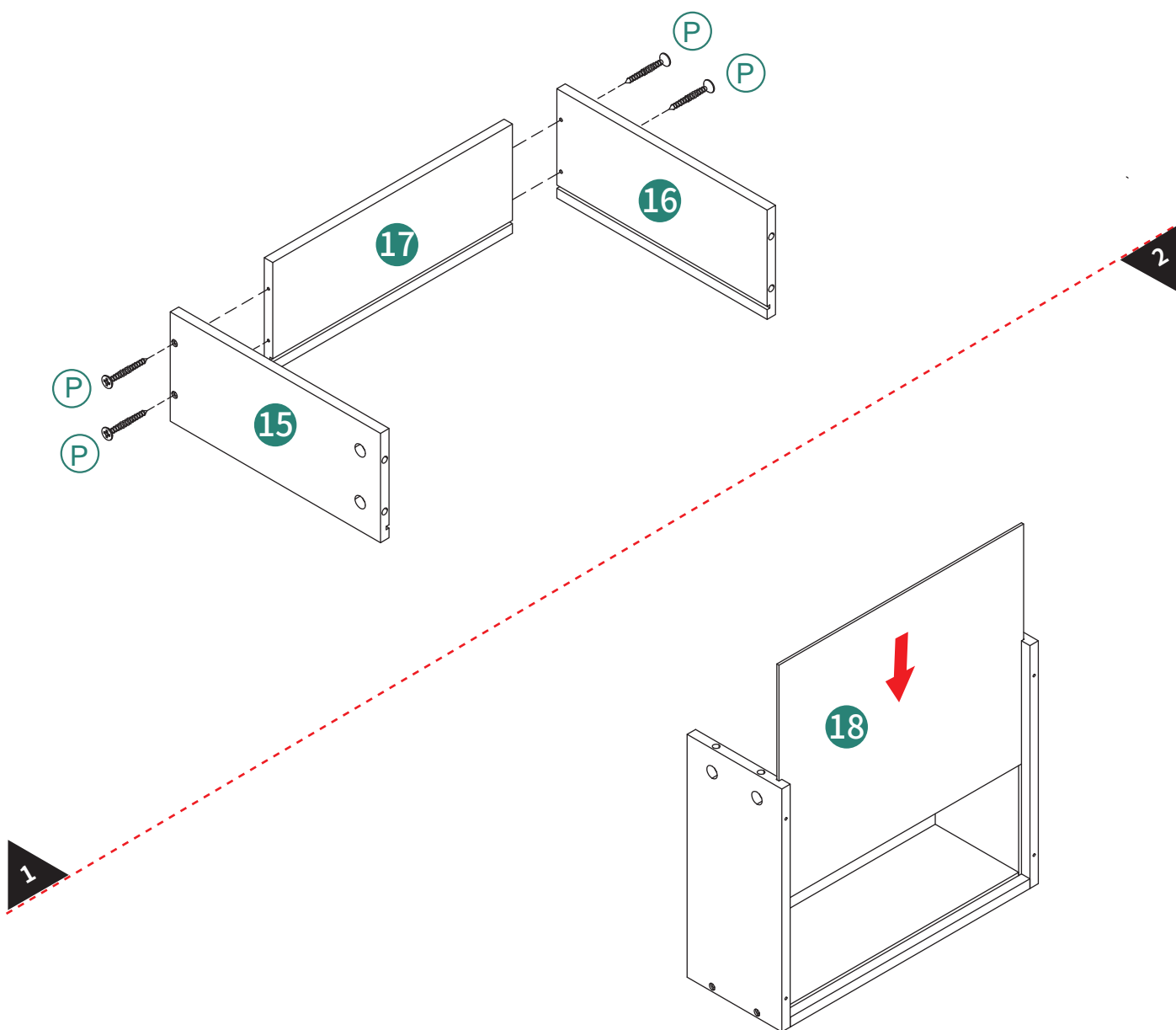

ASSEMBLY

13



ST3.5X12mm

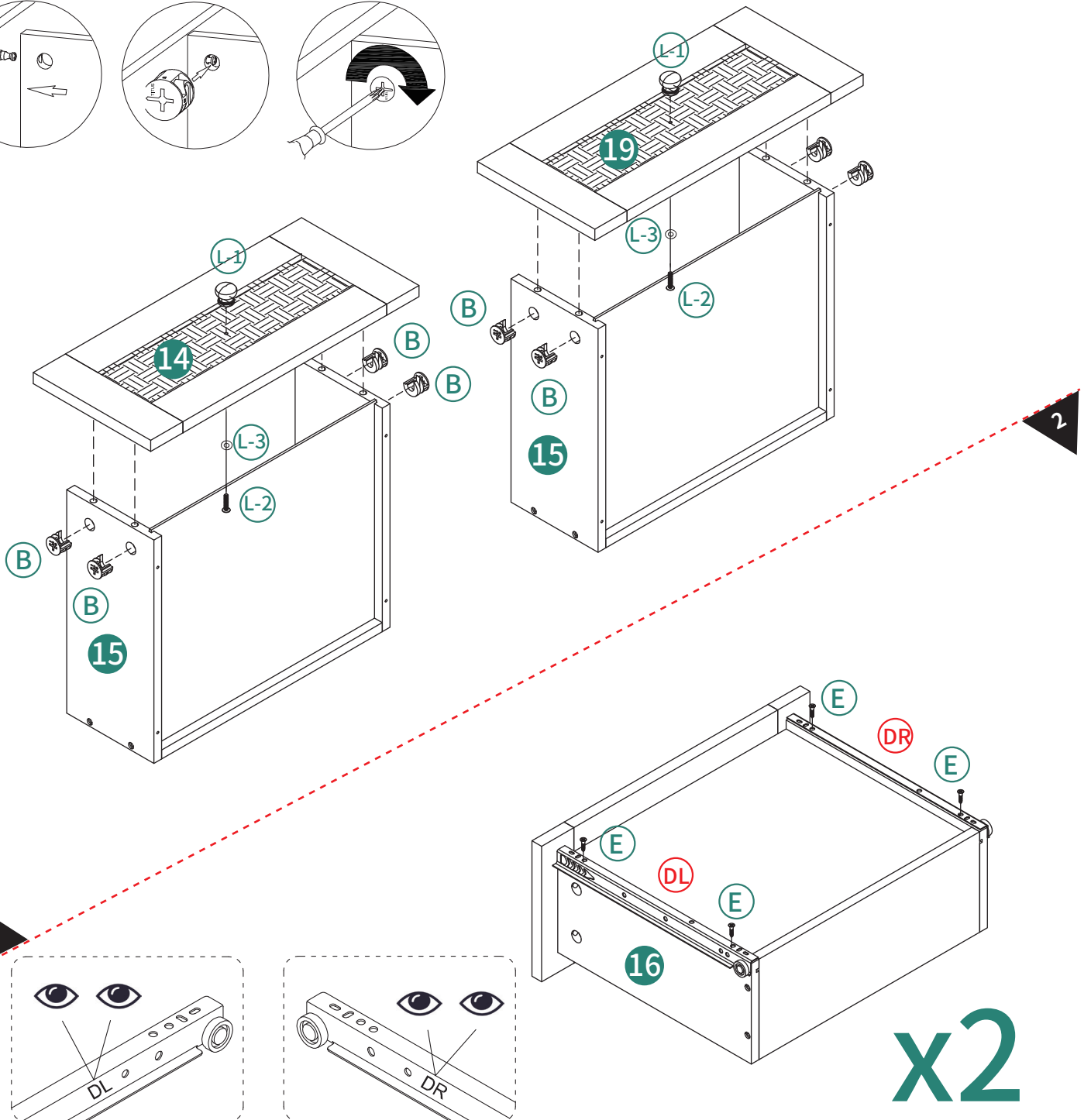
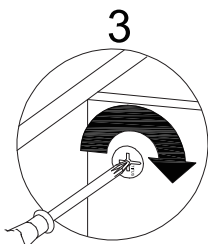
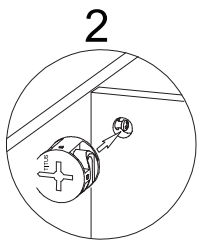
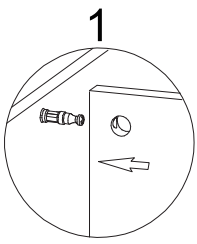
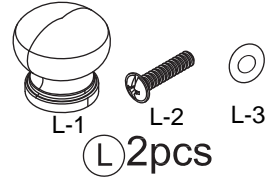
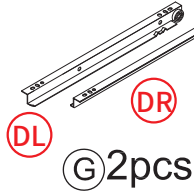

x2

ASSEMBLY

14

ST3.5X14mm

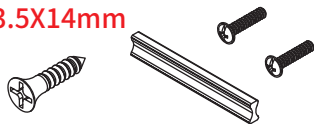

(H)16pcs (M)2pcs

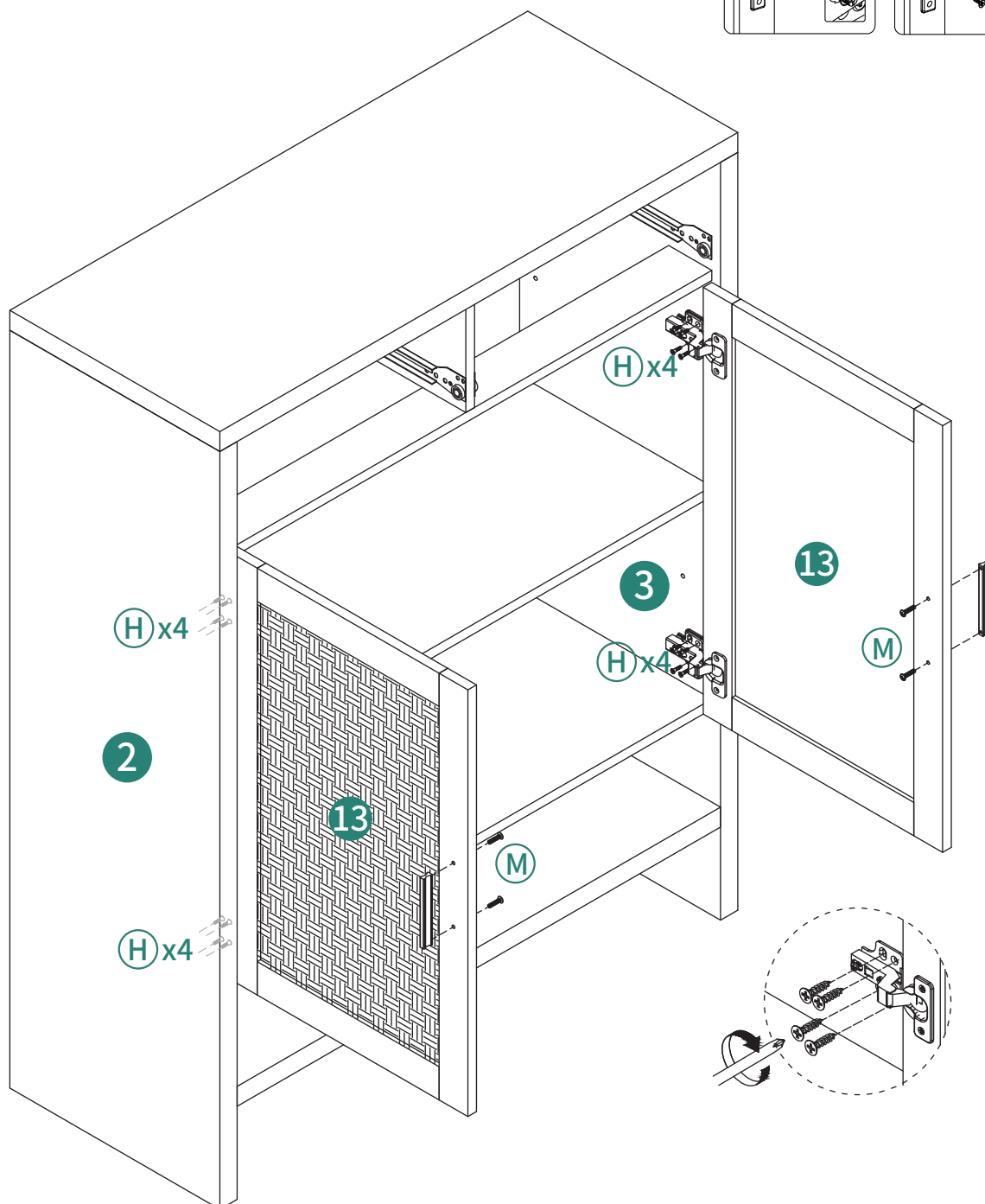
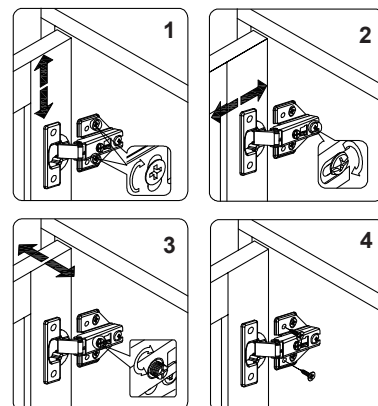

ASSEMBLY

15

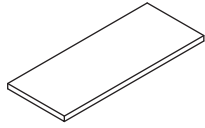

⑦ 2pcs

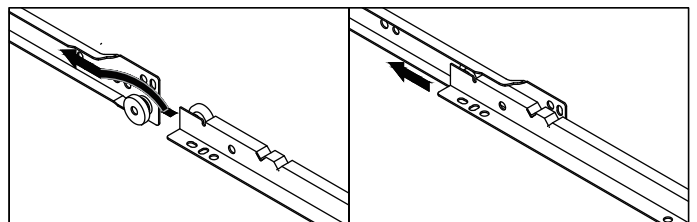
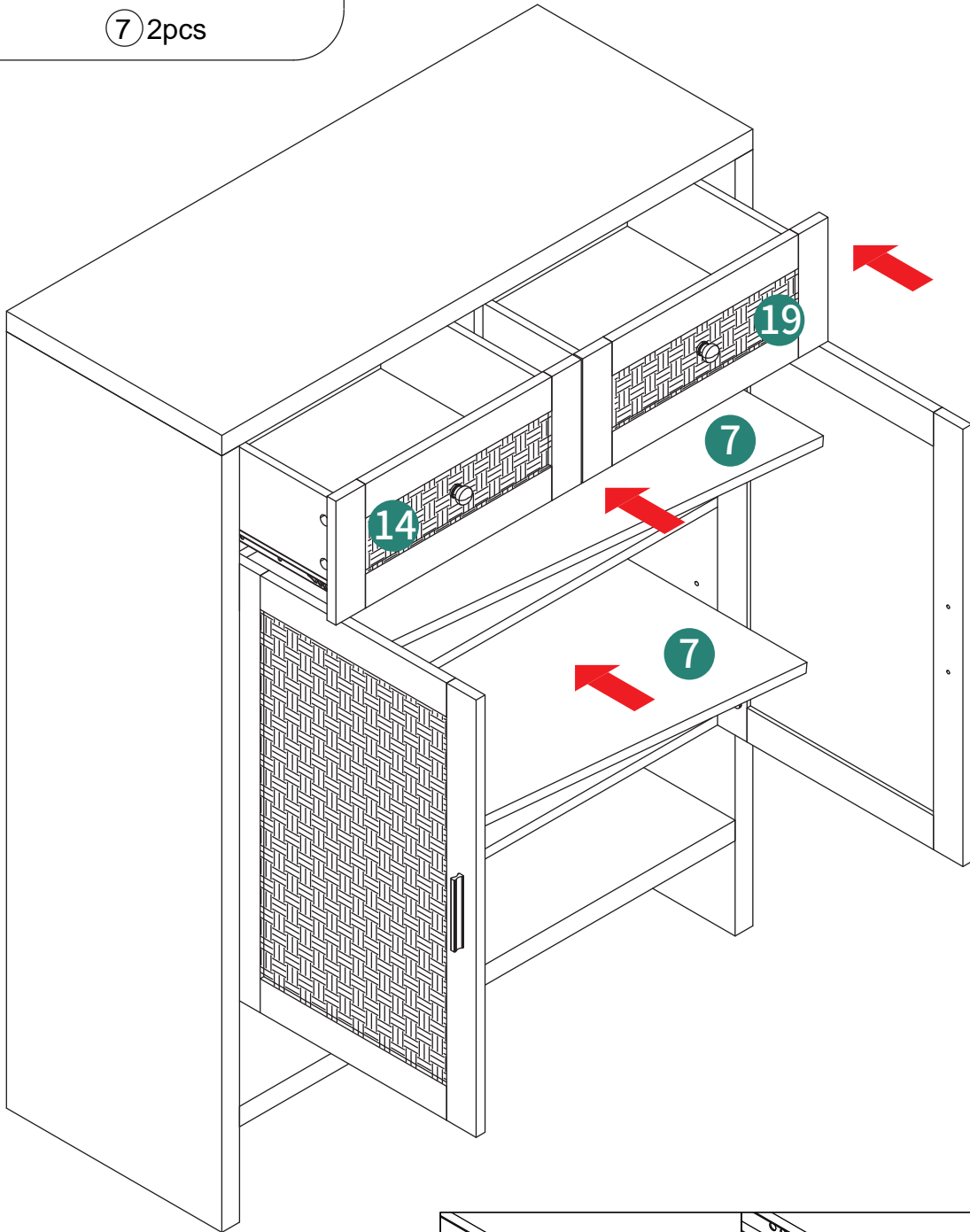

HELP CENTER



Inquiry



Assembly issue



Missing parts



Returns&Refunds

If you encounter any difficulties during assembly, please contact us.support@Yanosaku.com
Wenn Sie während der Montage auf Schwierigkeiten stoßen, kontaktieren Sie uns bitte support@Yanosaku.com

Si vous rencontrez des difficultés lors du montage, veuillez nous contacter support@Yanosaku.com

Se incontri difficoltà durante il montaggio, ti preghiamo di contattarci support@Yanosaku.com
Si encuentras alguna dificultad durante el ensamblaje, por favor contáctanos support@Yanosaku.com

DISCLAIMER

Manufacturer and seller expressly disclaim any and all liability for personal injury, property damage or loss, whether direct, indirect, or incidental, resulting from the incorrect attachment, improper use, inadequate maintenance, unapproved modification, or neglect of this product.

Der Hersteller und Verkäufer lehnen ausdrücklich jegliche Haftung für Personenschäden, Sachschäden oder Verluste ab, egal ob direkt, indirekt oder zufällig, die durch falsche Anbringung, unsachgemäßen Gebrauch, unzureichende Wartung, nicht genehmigte Änderungen oder Vernachlässigung dieses Produkts entstehen.

El fabricante y vendedor renuncian expresamente a toda responsabilidad por lesiones personales, daños materiales o pérdidas, ya sean directos, indirectos o incidentales, derivados de la incorrecta colocación, uso inadecuado, mantenimiento insuficiente, modificación no aprobada o negligencia de este producto.

Il produttore e il venditore declinano espressamente ogni responsabilità per lesioni personali, danni materiali o perdite, dirette, indirette o incidentali, derivanti dall'errato fissaggio, uso improprio, manutenzione inadeguata, modifica non autorizzata o negligenza di questo prodotto.

Le fabricant et le vendeur déclinent expressément toute responsabilité en cas de blessures corporelles, de dommages matériels ou de pertes, qu'ils soient directs, indirects ou accessoires, résultant de la fixation incorrecte, de l'utilisation inappropriée, de l'entretien insuffisant, de la modification non approuvée ou de la négligence de ce produit.