

# Outdoor Storage Shed

Product ID. QUGYS



Scan for Support  
[support@garvee.com](mailto:support@garvee.com)



Distributed by  
**GARVEE**.com

V251230I9SW

# Assembly Preparation

## Owner's Manual :

Please check local building codes regarding footings, location and other requirements before beginning construction.

## Assembly instructions:

Reviewing all instructions and the appropriate information before you begin, make sure following the step sequence carefully for successful results.

## Flooring base:

A good location for the storage building is a square and level area with good drainage. The base is not included in the kit which may need

purchase separately or may construct a foundation and anchoring system of your own.

A strong plastic sheet (thickness: at least 150µm) should be placed under the foundation to assist in reducing rising dampness from the soil, thus

reducing condensation build up in the shed. Your storage building must be anchored to prevent wind damage. Once secured, it is highly

recommended applying silicone along the inside of the base rail to minimize condensation.

## Parts and Parts List:

Before you start, separate and identify all the parts and hardware to be sure that you have all the necessary parts for your building (refer to the

Parts List Page), If you find that a part is missing, please notify the seller within one week after receiving the product. Do not attempt to assemble

the building if parts are missing because any building left partially assembled may be seriously damaged by light winds.

## Tools you need:

( Please tear off the safety protection layer before the assembly, keep the part number label if needed)

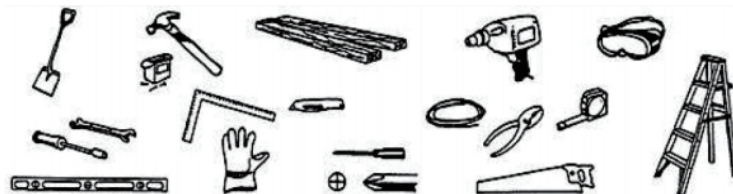

## Safety must be put in the No. 1 position:

1. Select a dry and calm day for your assembly. Team works (Two or more people) are required during the assembly. It is also recommended to

finish the assembly in a day to avoid damage to the product or missing of some small parts.

2. Wearing safety gloves, eye protection and long sleeves during the assembly to prevent injury. Pay attention to the sharp edge of some parts.

3. Children and pets are not allowed entering into the construction site.

4. Never concentrate your total weight on the roof of the building.

When using a step ladder make sure that it is safe.

## Care & Maintenance:

1. Keep the shed clean with soft cloth, use water if necessary.

2. Keep the door tracks clear of dirt and other stuff that prevent them from sliding easily.

3. Clean the snow with necessary tools to make sure it is safe to enter into.



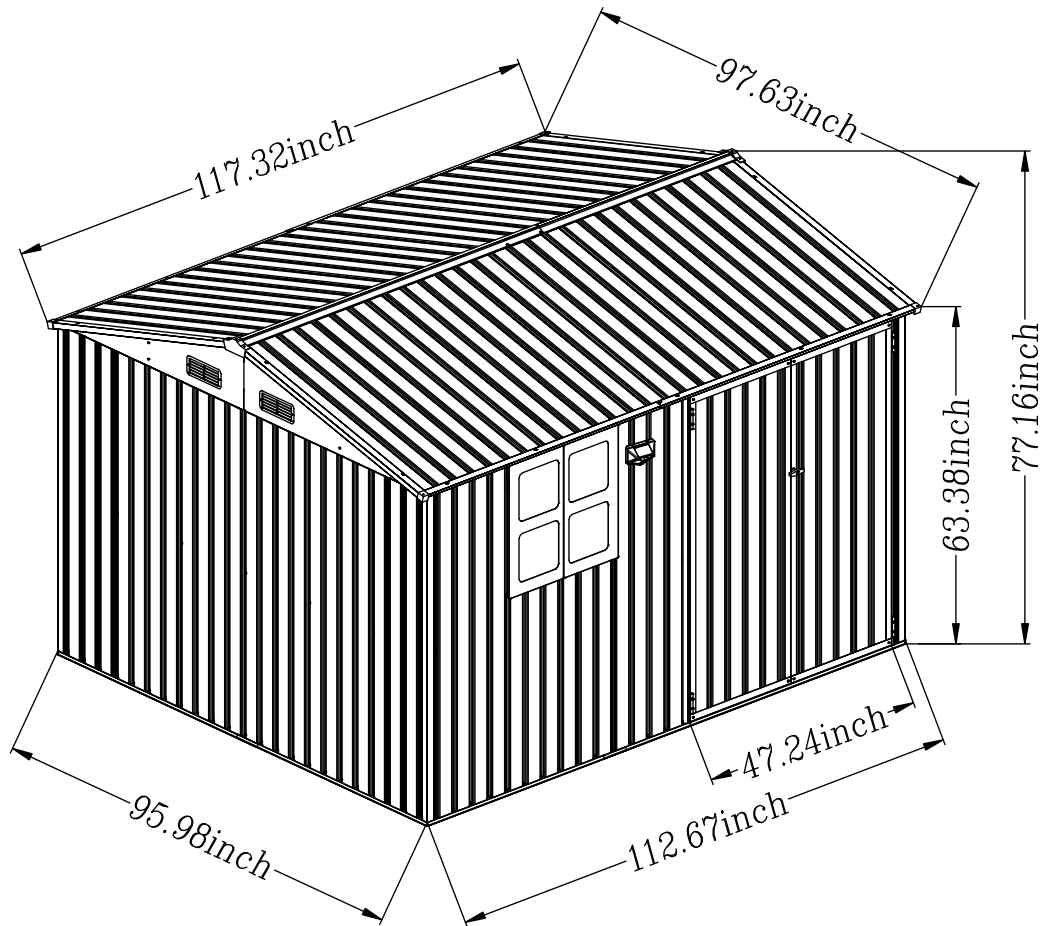

4. The shed is not made for living but storing stuff.

5. Please add some oil on the top and bottom door sliding channel to make door slides smoothly.







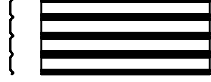











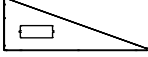
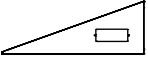





Size :

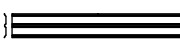

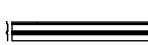





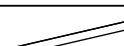



















# Hardware List A

PART	NO.	QTY.
	W5	16
	W5-k	2
	F810-7L	2
	F810-7M	10
	F810-7R	2
	W5-F	1

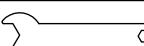
# Hardware List B

PART	NO.	QTY.
	F810-1L	2
	F810-1R	2
	F810-2L	2
	F68-2R	2
	F810-3L	2
	F68-3R	2
	F810-4L	2
	F810-4R	2
	F810-5L	2
	F810-5R	2
	K1010-6L	4
	K1010-6R	4
	F810-8	4
	F810-9L	2
	F810-9R	2
	K810-10	1
	K1012-10R	1
	W3	1
	W5-C	4
	W2-HL	1
	W2-HR	1
	W3-F	1
	UA	2
	DA	2
	DLA	1
	DRA	1
	DDA	4

PART	NO.	QTY.
	DBA	4
	C4	4
	C3	4
	TCH	2
	TCH3	1
	TCH5	1
	TCH6	1
	TCH7	1
	GC	4
	GE	2
	T-F	4
	F1	461
	F2	70
	F3	32
	V2	152
	F4	4
	DC	2
	C2-1	1
	C2	3
	DH	4
	GL	1
	SL	62
	GF	4
	M20	1
	ST	1
	LED	1
	3M adhesive	1

# Component List

## Shed top Panels

NO.	QTY.
F810-8	4
F810-9L	2
F810-9R	2
F810-7M	10
F810-7L	2
F810-7R	2
K810-10	1
K1012-10R	1
GC	4
GE	2

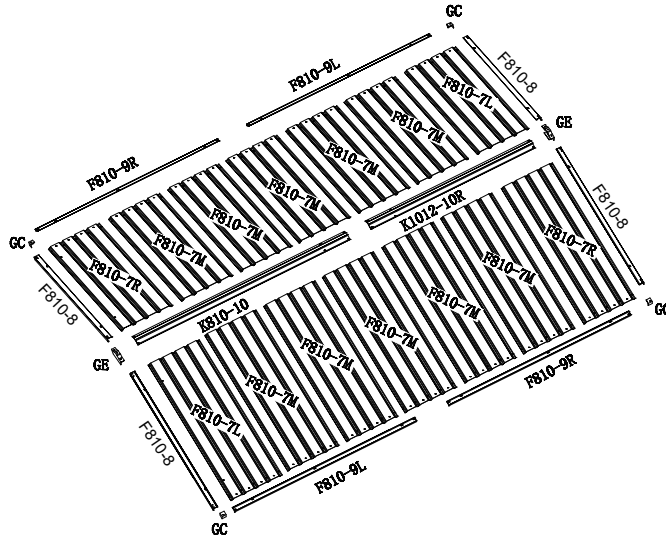

## Shed top frame

NO.	QTY.
F810-4L	2
F810-4R	2
F68-3R	2
F810-3L	2
K1010-6L	4
K1010-6R	4
F810-5L	2
F810-5R	2
C4	4
C3	4

NO.	QTY.
C2	3
C2-1	1
GF	4

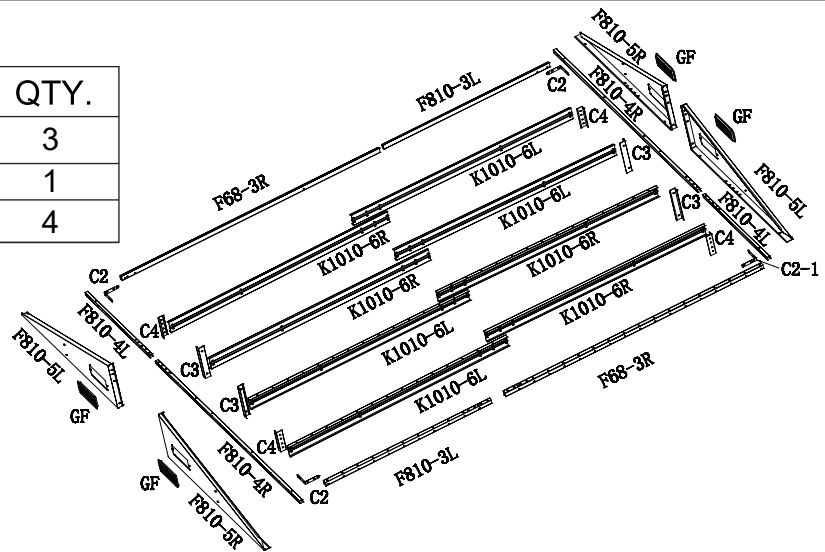

## Door

NO.	QTY.
W2-HL	1
W2-HR	1
W5-K	2
DDA	4
DBA	4
DLA	1
DRA	1
DC	2
DA	2
DH	4
UA	2
GL	1

## Shed base

NO.	QTY.
F810-1L	2
F810-1R	2
F810-2L	2
F68-2R	2
T-F	4

## Shed side

NO.	QTY.
W5	16
W3	1
W5-C	4
W5-F	1
W3-F	1
TCH3	1
TCH5	1
TCH6	1
TCH7	1
TCH	2

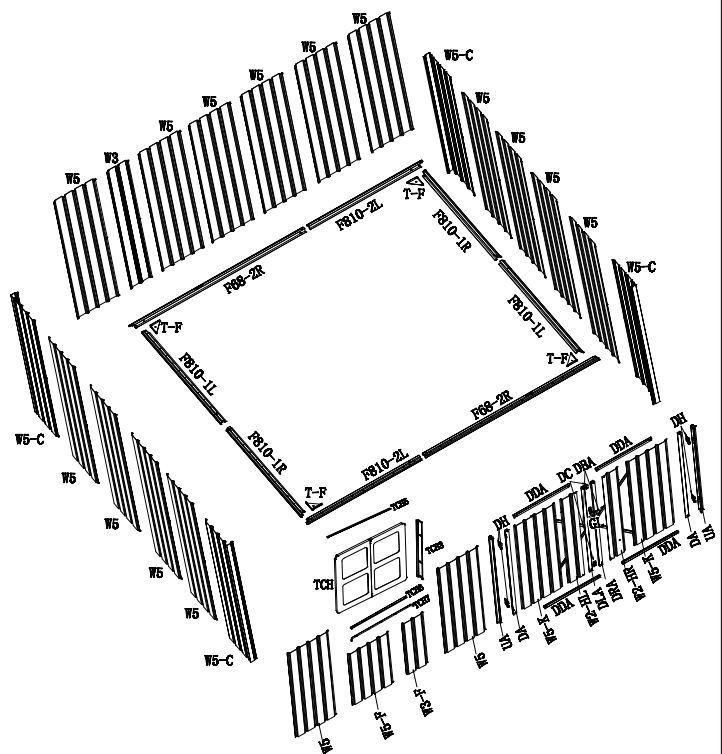

# Top Plate

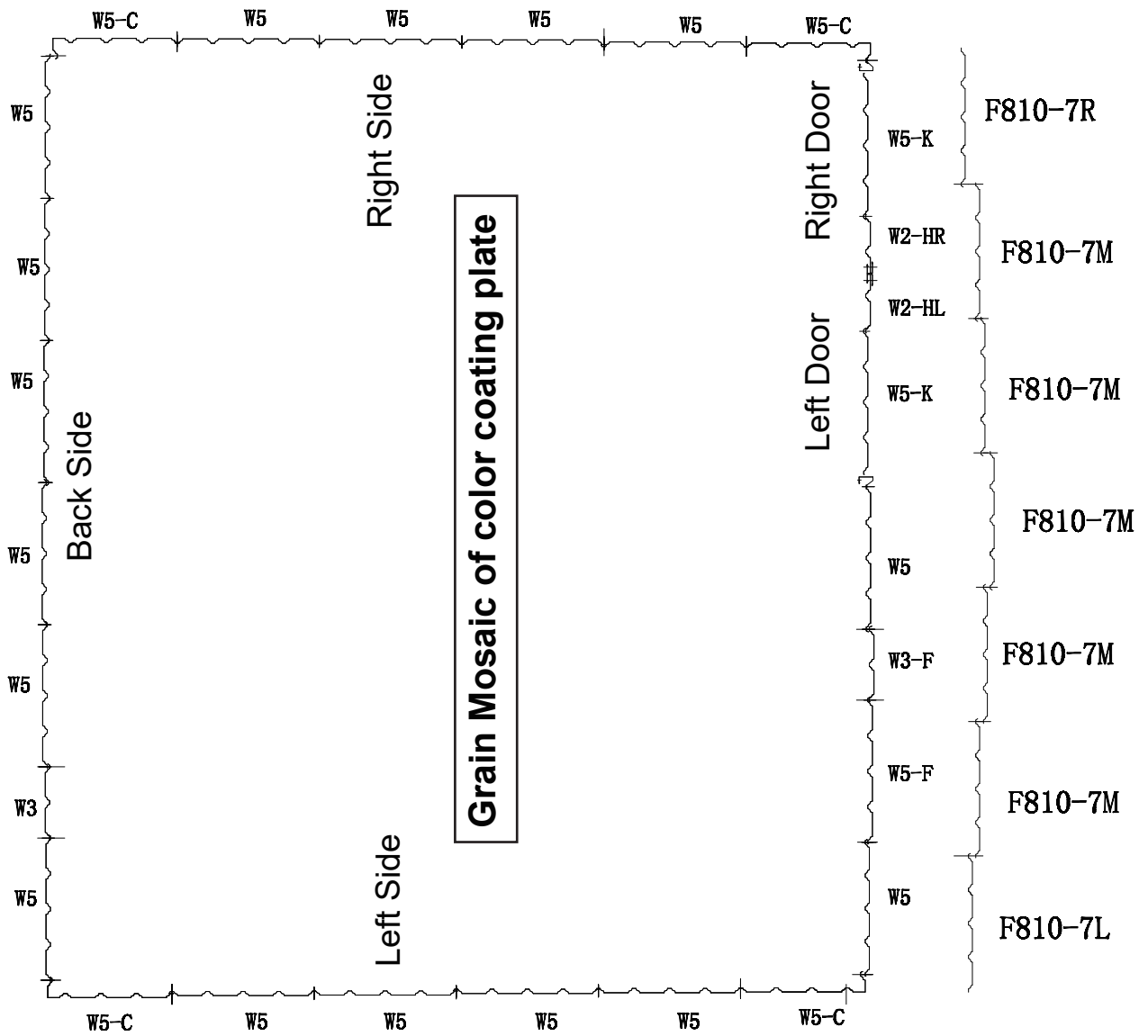

# Shed Base Frame Assemble

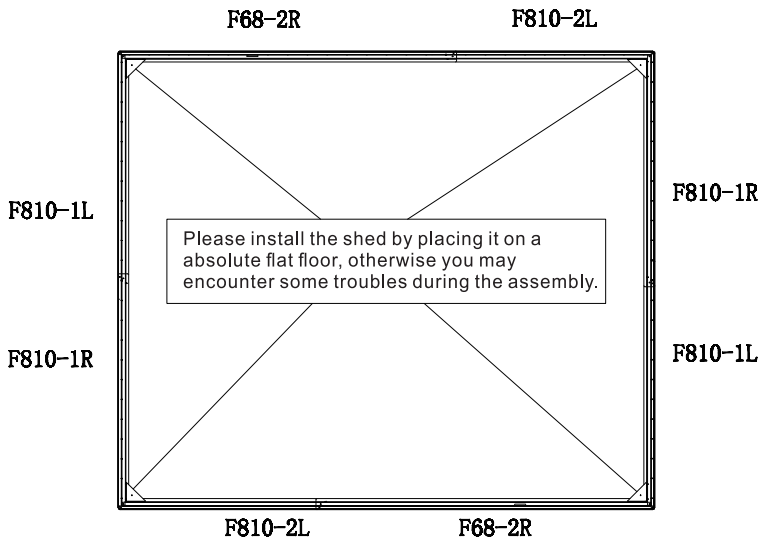

PART	NO.	QTY.
	F810-1L	2
	F810-1R	2
	F810-2L	2
	F68-2R	2
	T-F	4
	F1	36

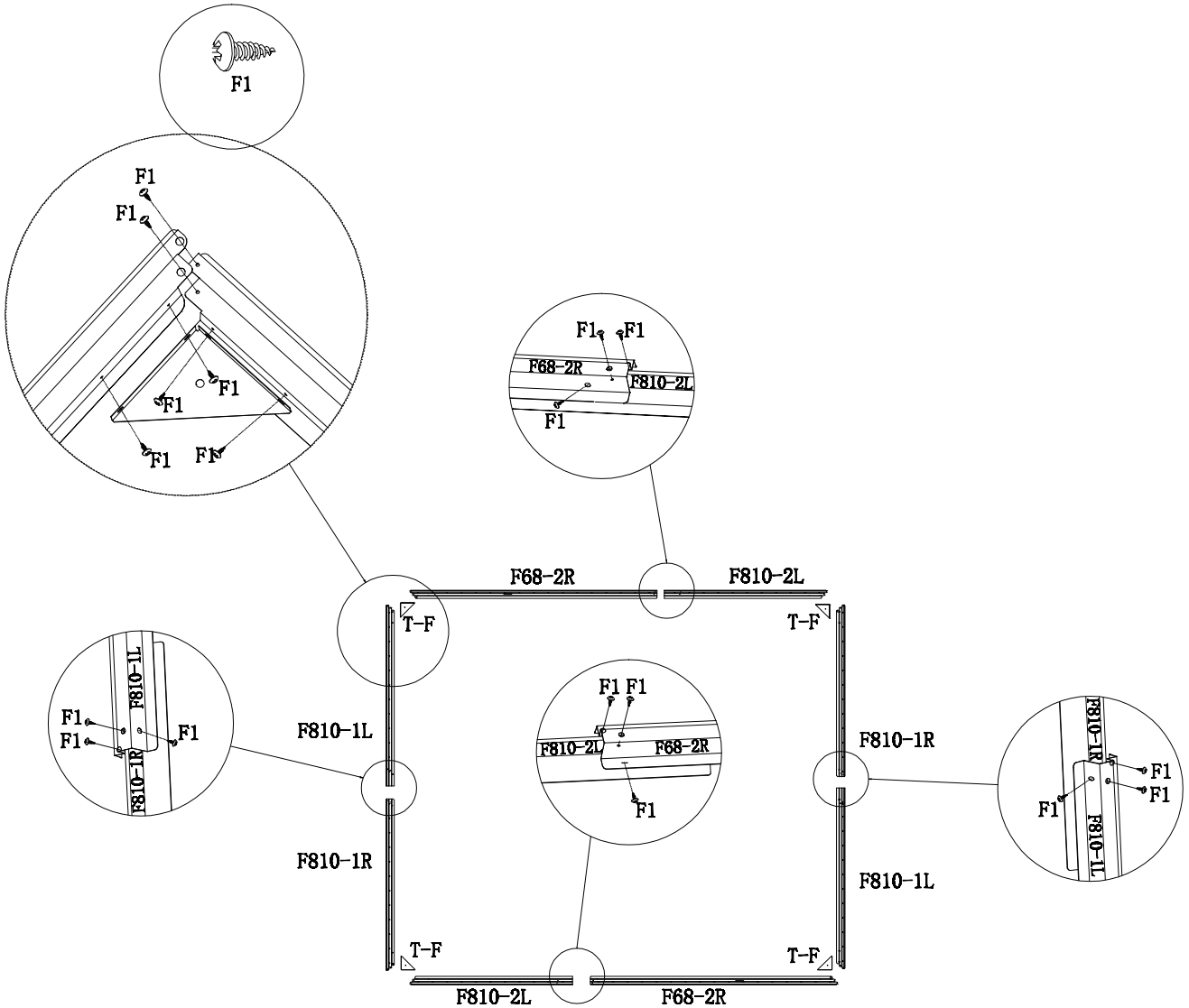

Note: The larger hole is always covered over the small hole.

# Shed Side Panels Assemble

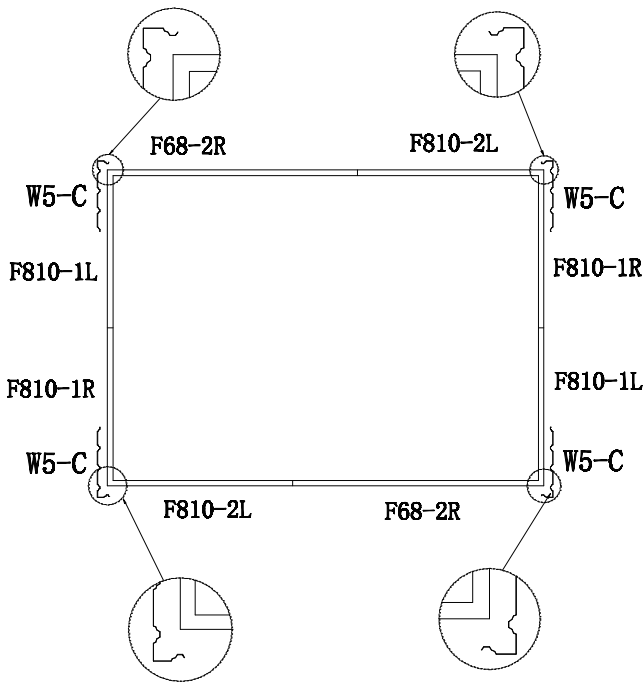



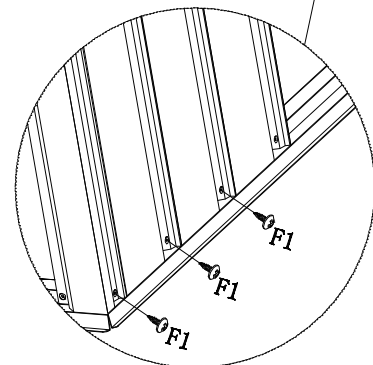
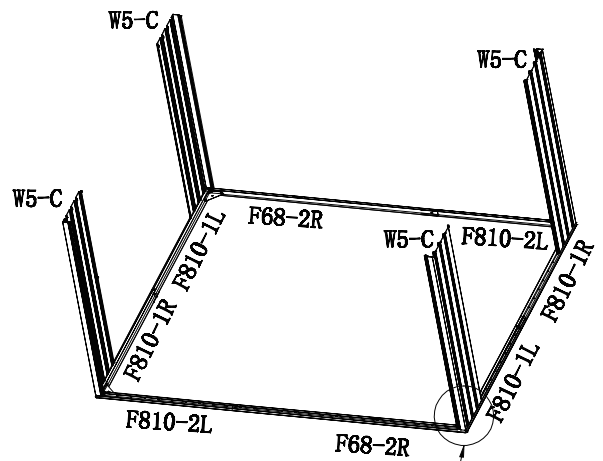
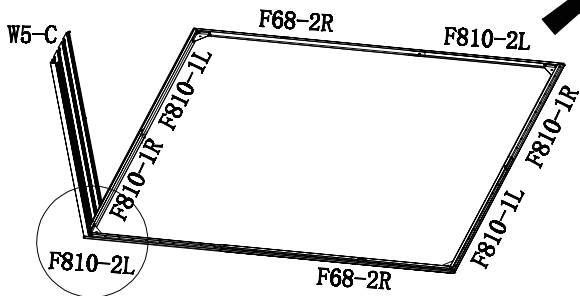



PART	NO.	QTY.
	W5-C	4
	F1	12



**Note2:**

It's advised to fix the shed on the ground or deck with screw/pin thru the middle hole(dia.=4mm) on part #T-F for better stability.

**Note1 :** The colored side should be facing out.

PART	NO.	QTY.
	F810-4L	2
	F810-4R	2
	F810-3L	2
	F68-3R	2
	F1	44
	C2-1	1
	C2	3

 Two Adults Are Required

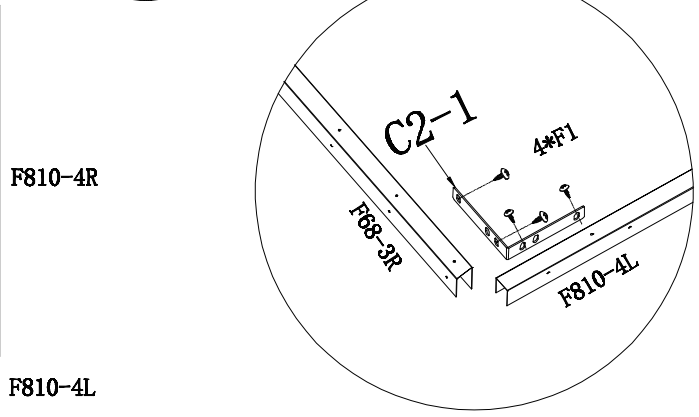
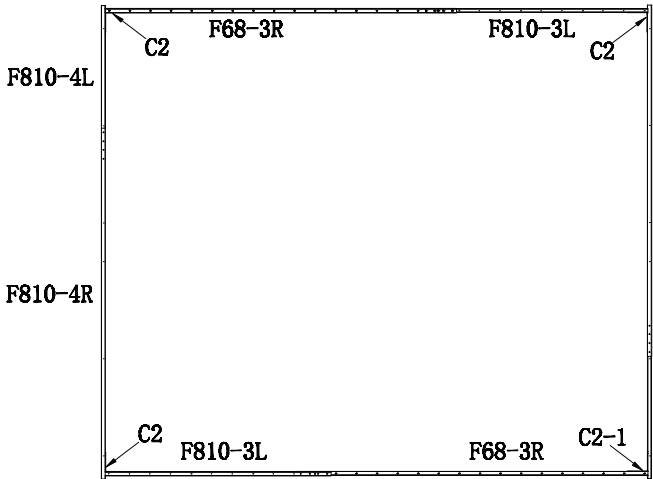
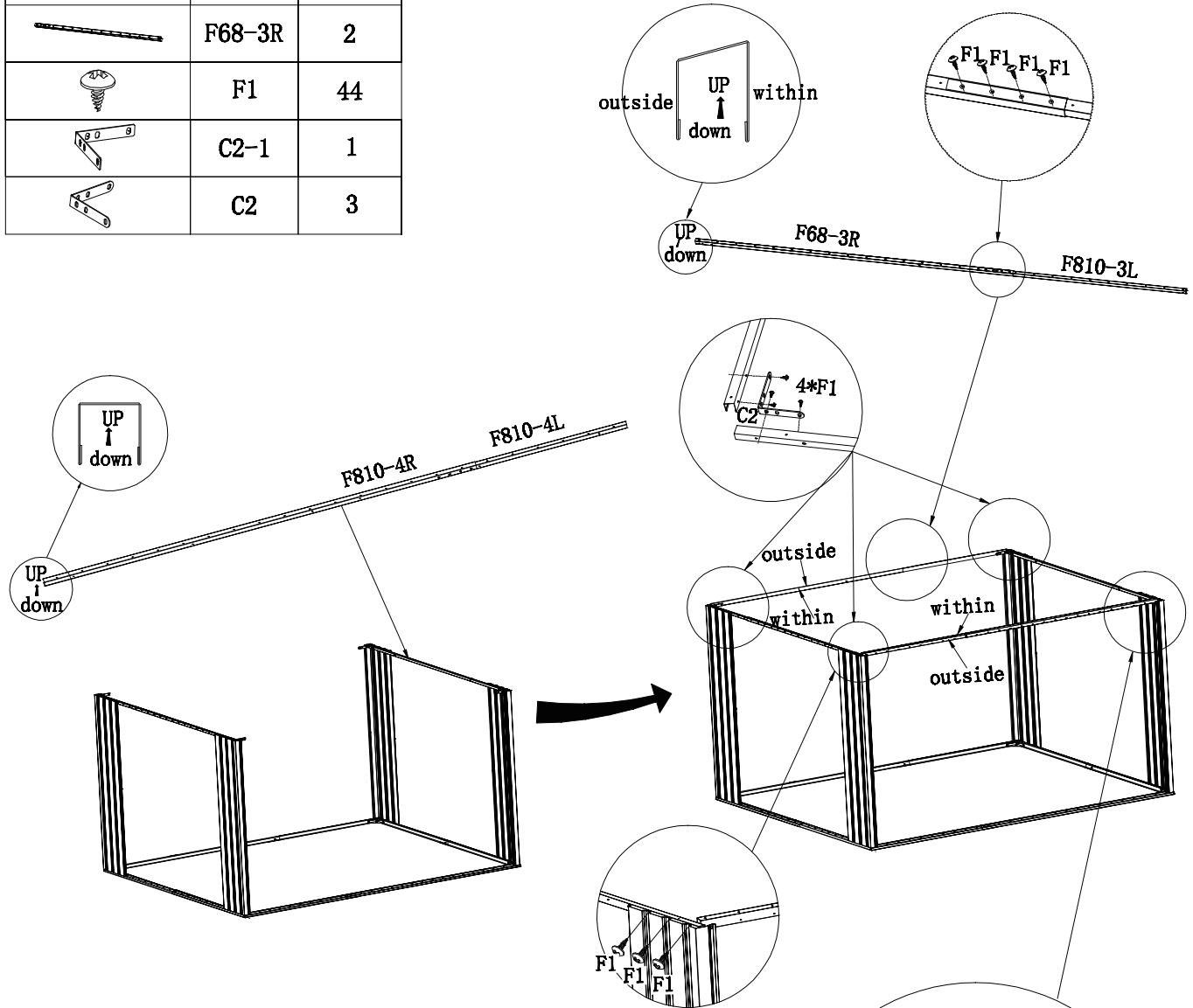

Tip: For the convenience of installation, please install two "F68-3R+F810-3L" first, then install "C2" and finally install "F810-4R".

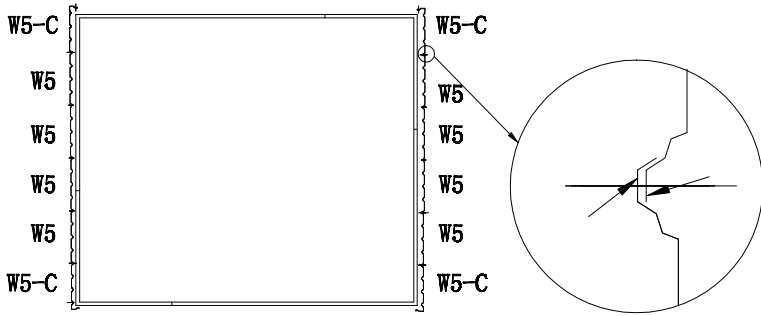

PART	NO.	QTY.
	W5	8
	F1	68
	F2	10

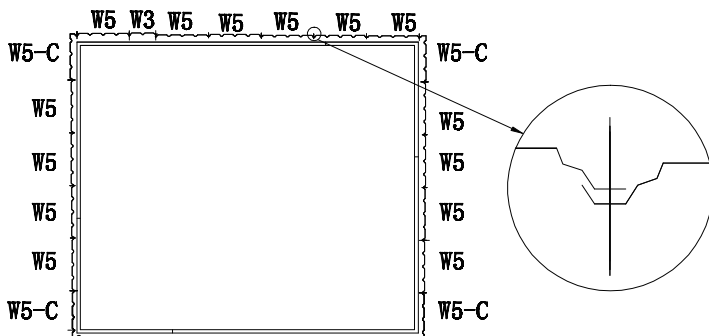
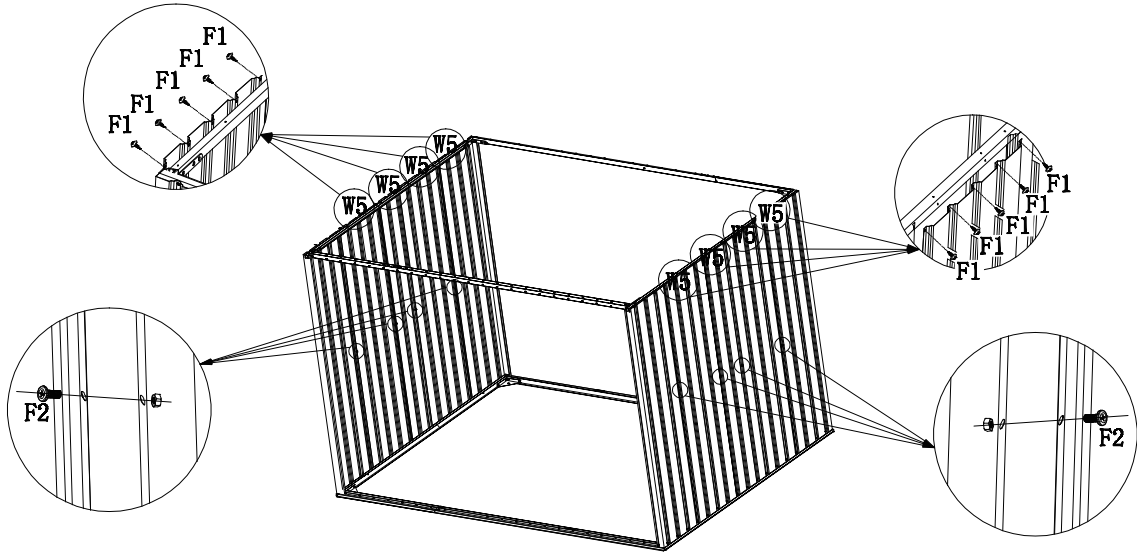

PART	NO.	QTY.
	W5	6
	W3	1
	F1	54
	F2	8

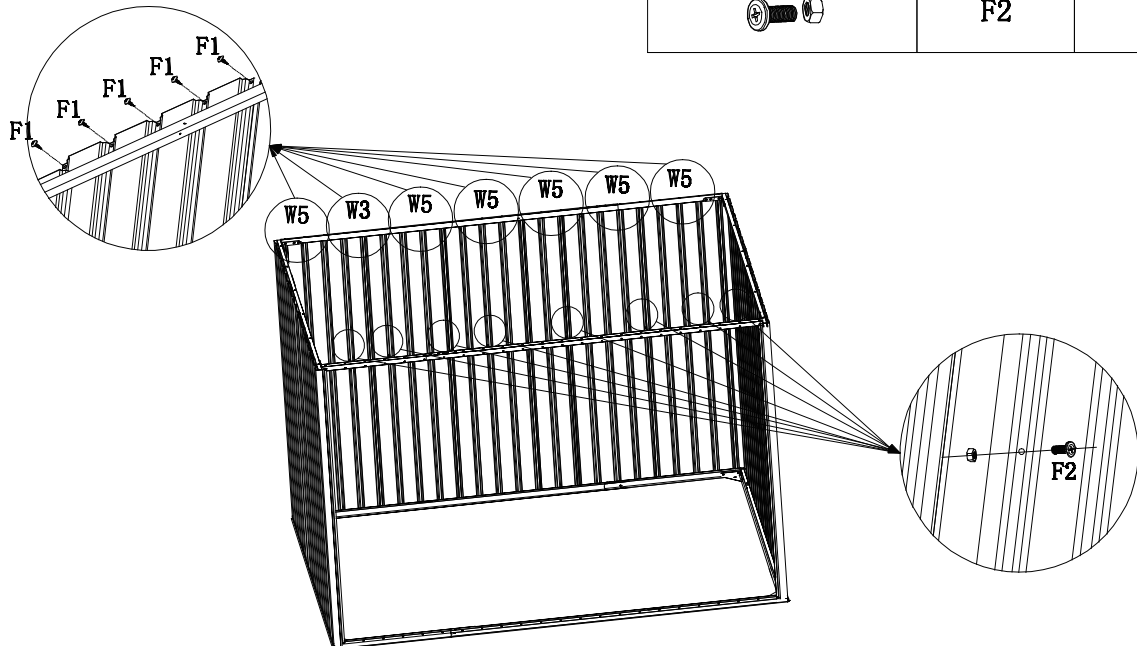





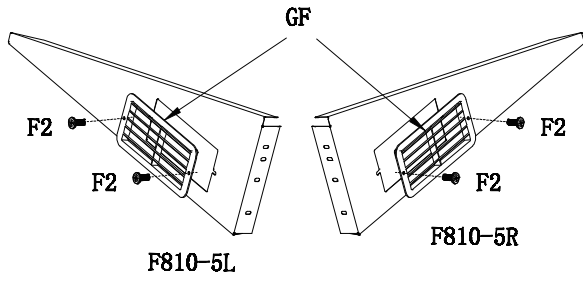

# Shed Top Frame Assemble

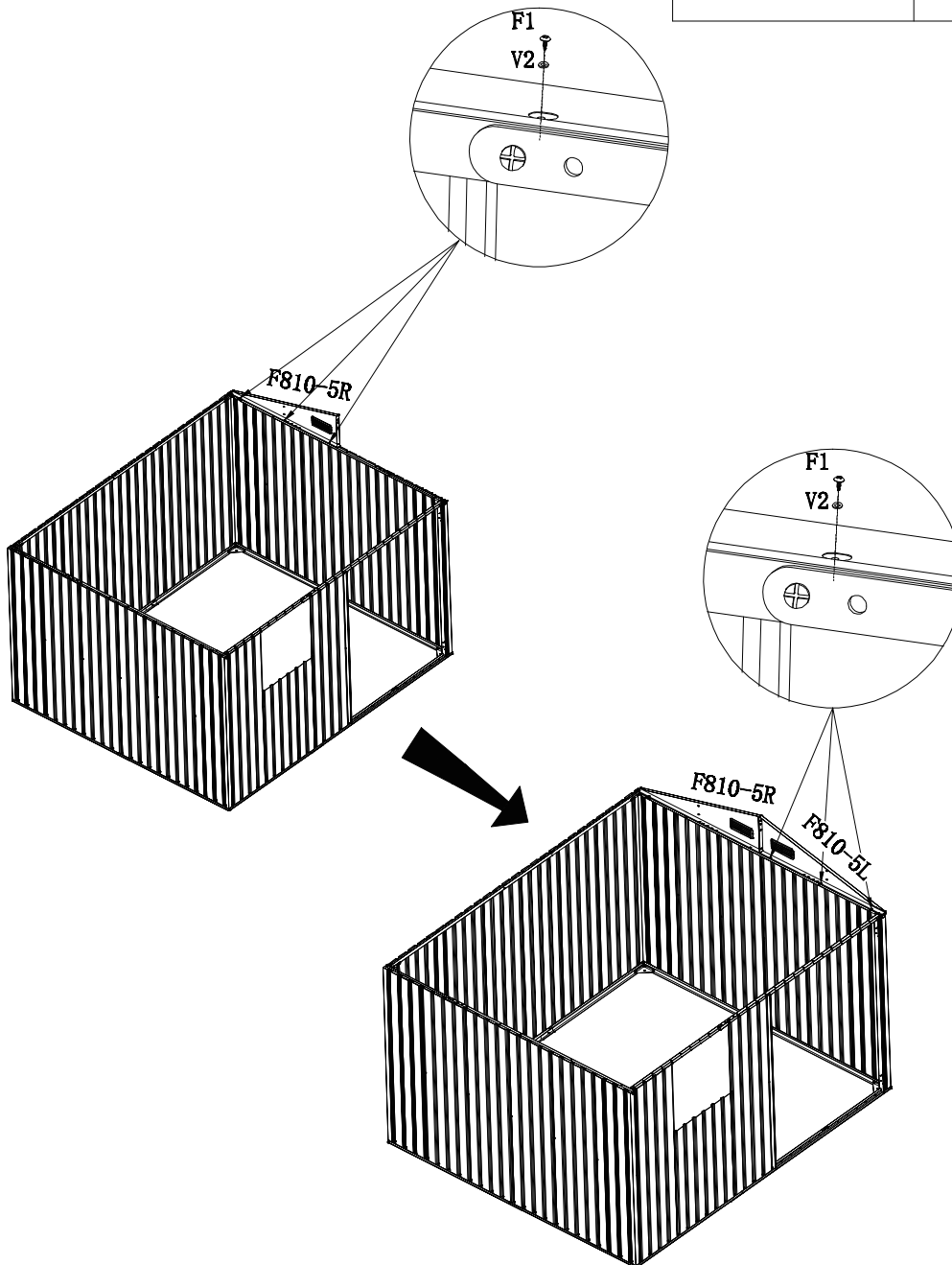

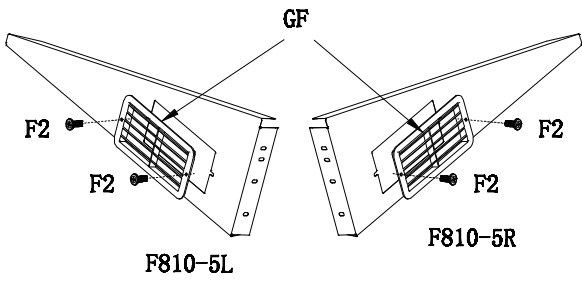

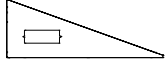
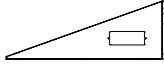

PART	NO.	QTY.
	F810-5L	1
	F810-5R	1
	F1	6
	V2	6
	GF	2
	F2	4



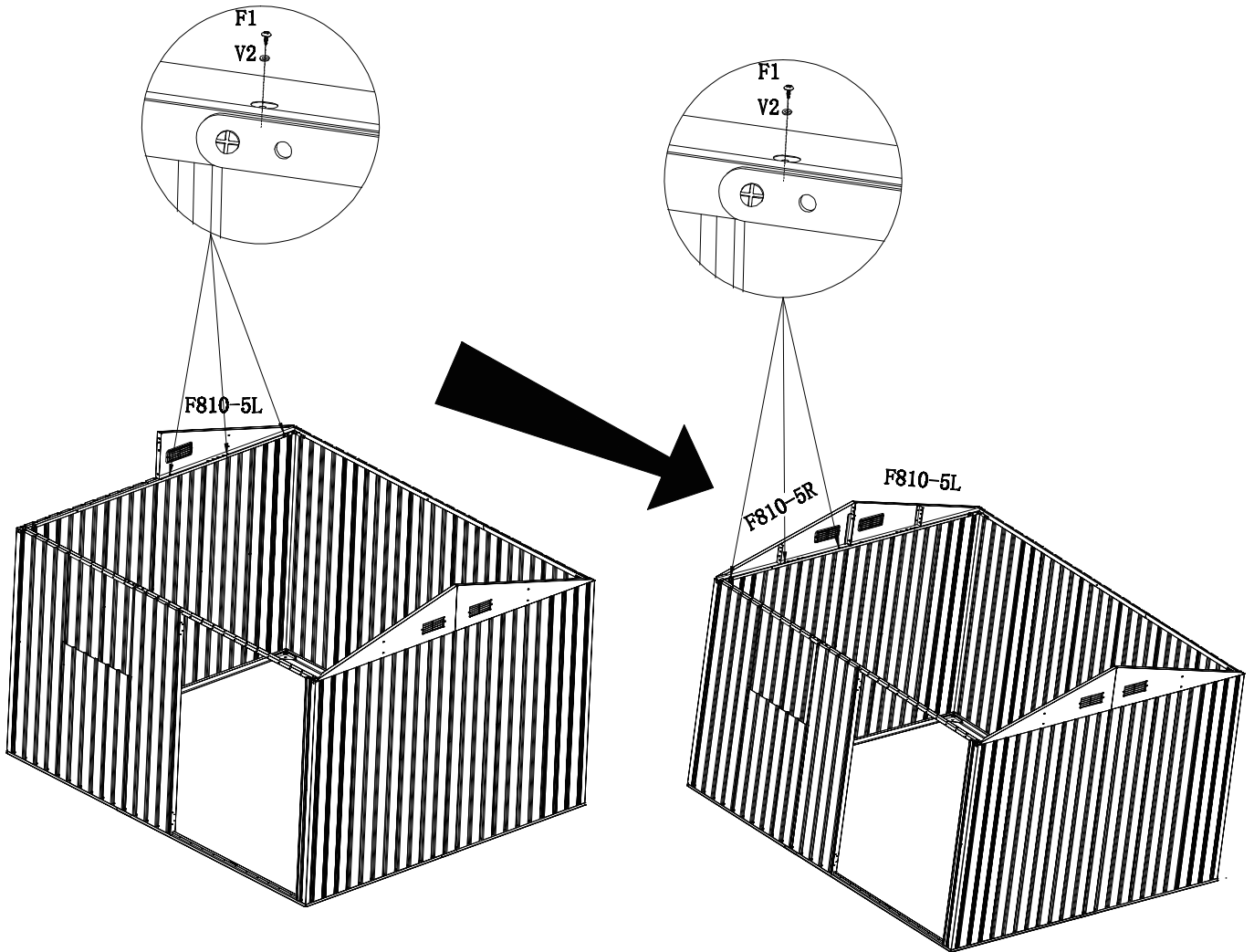

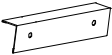



PART	NO.	QTY.
	F810-5L	1
	F810-5R	1
	F1	6
	V2	6
	GF	2
	F2	4



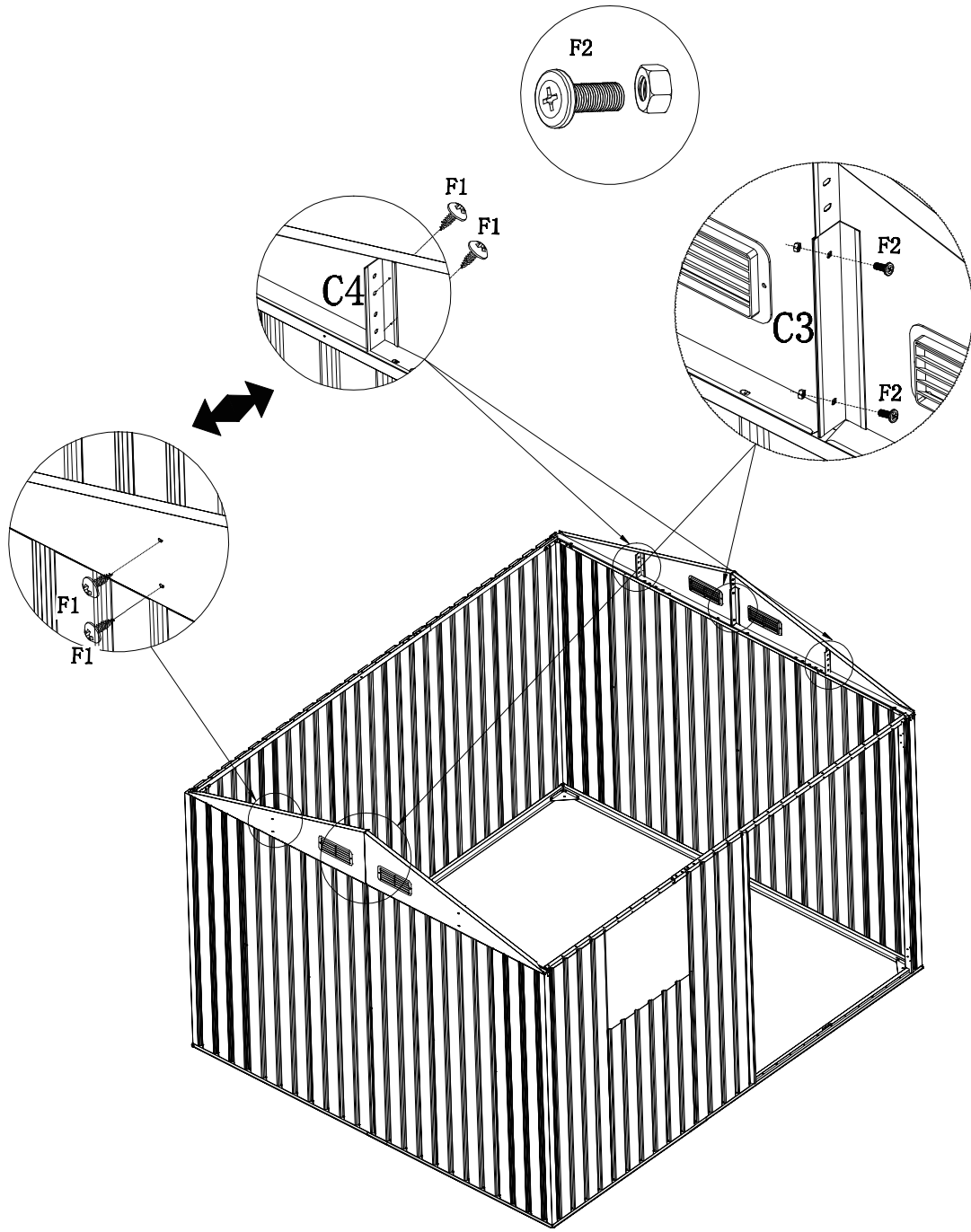

PART	NO.	QTY.
	C3	4
	C4	4
	F2	4
	F1	8

 Two Adults Are Required



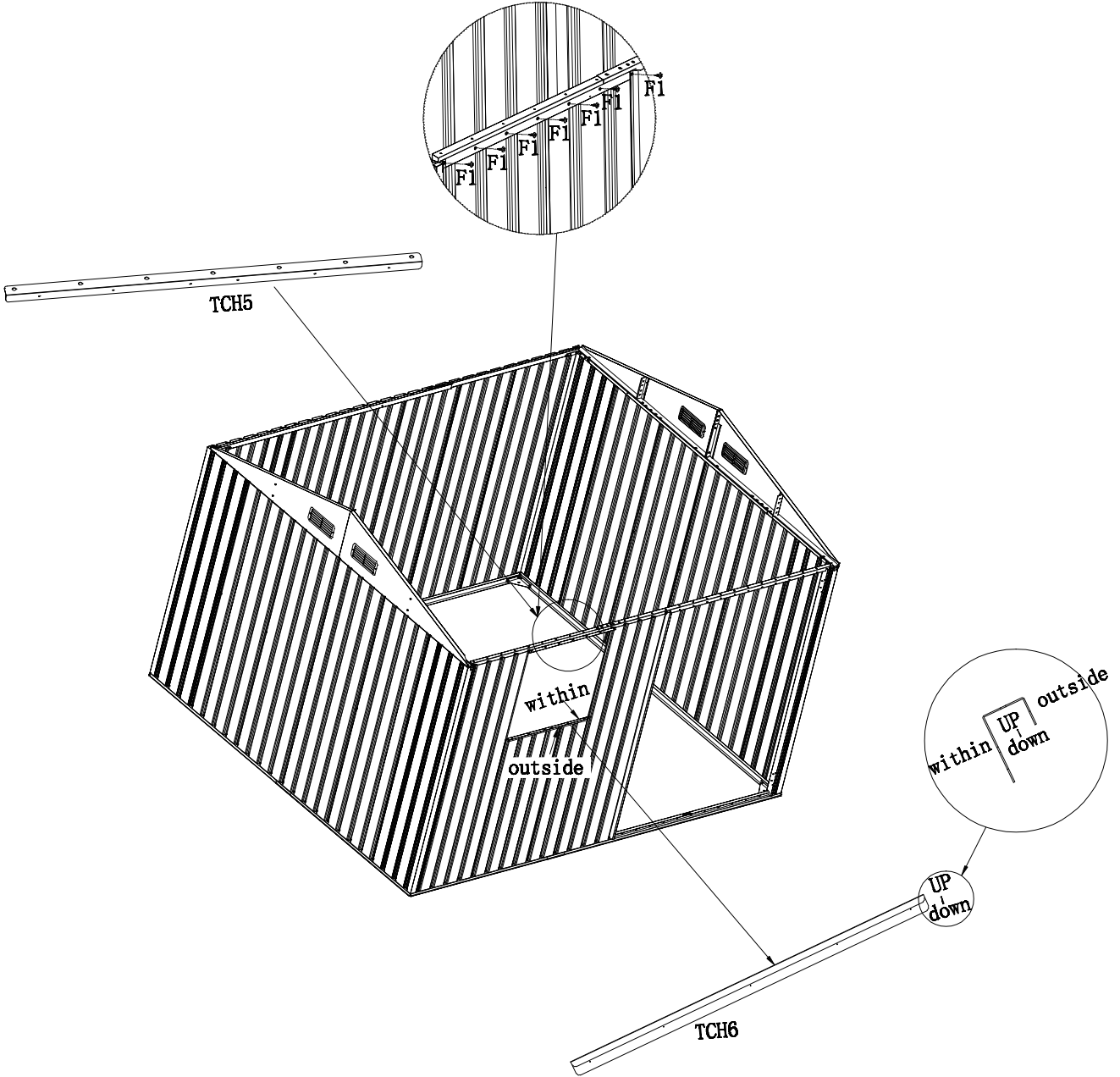

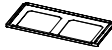
PART	NO.	QTY.
	TCH5	1
	TCH6	1
	F1	7



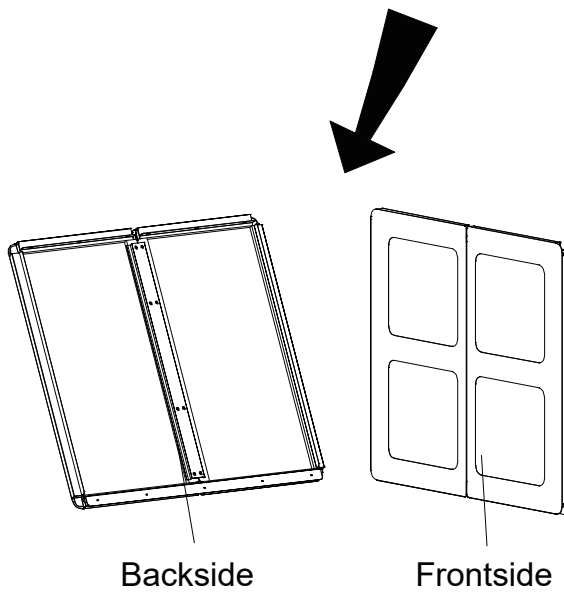
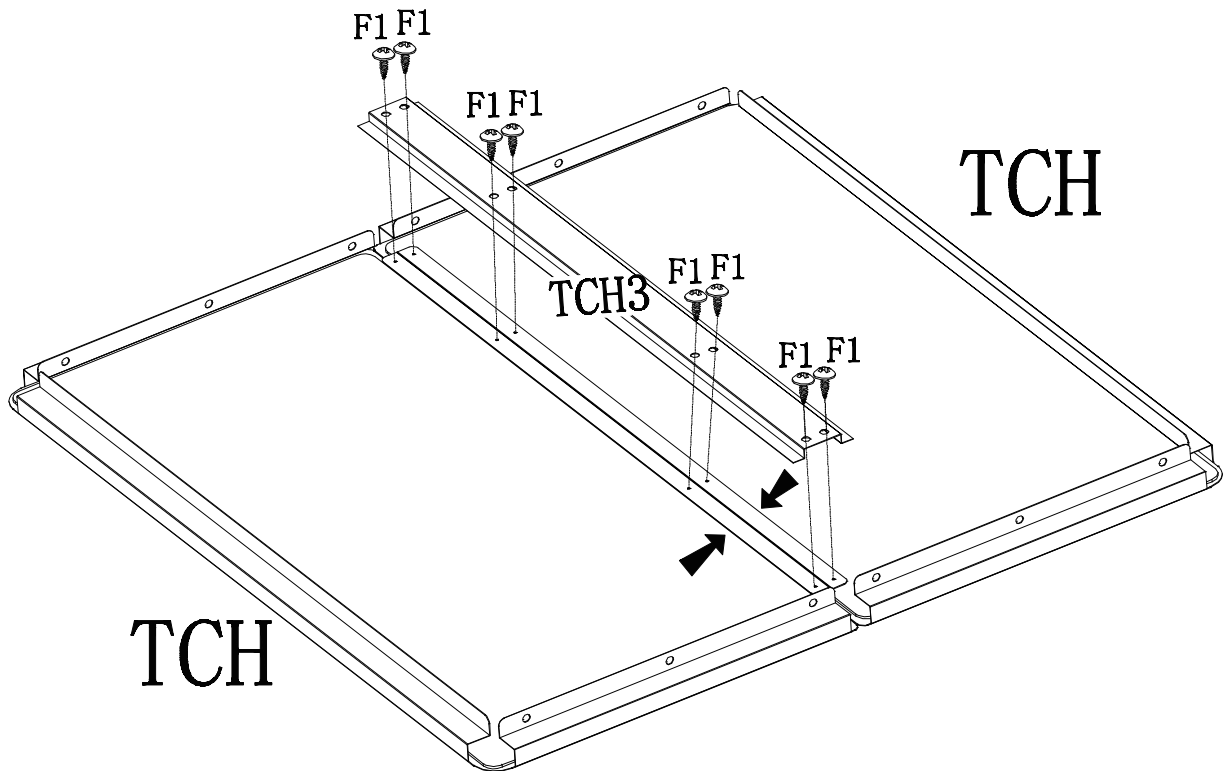

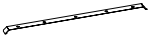
PART	NO.	QTY.
	TCH	2
	TCH3	1
	F1	8



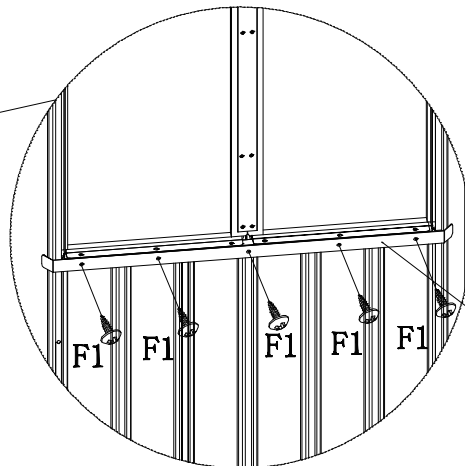
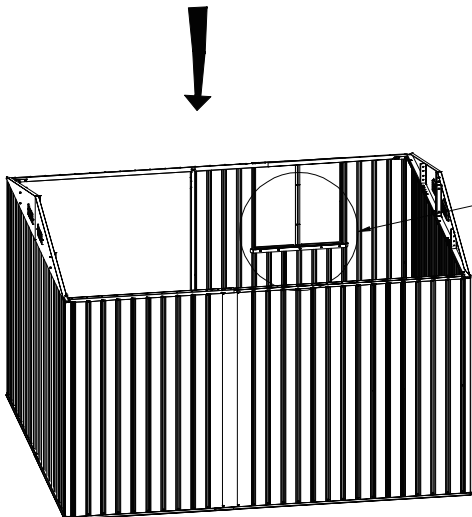
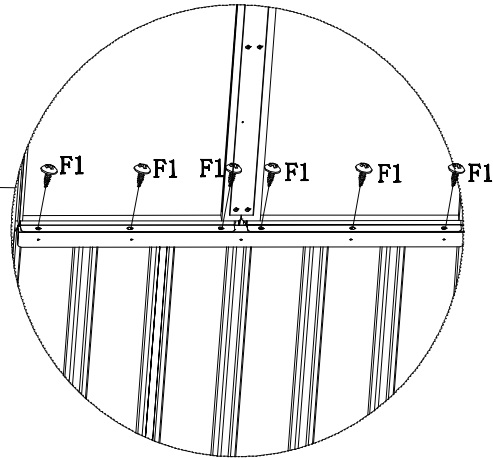
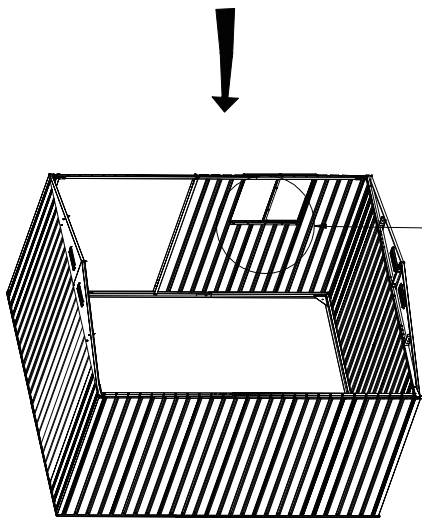
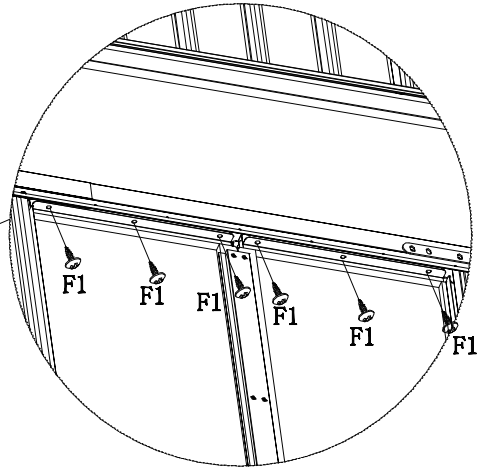
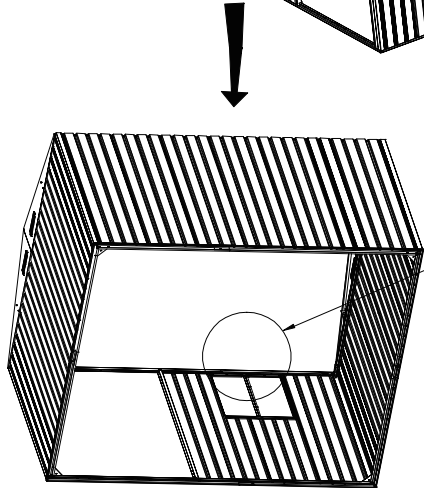
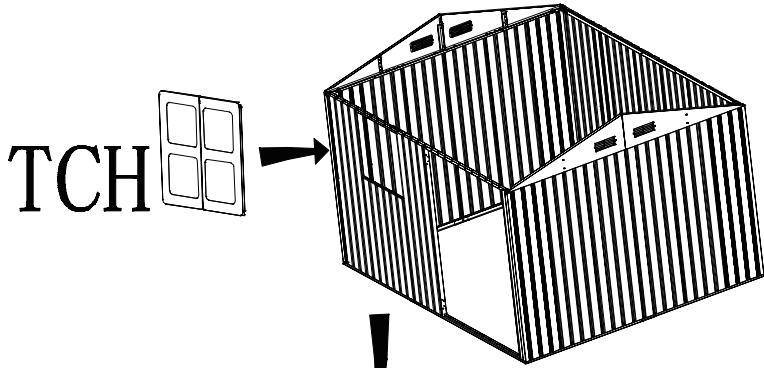



PART	NO.	QTY.
	TCH	1
	TCH7	1
	F1	17

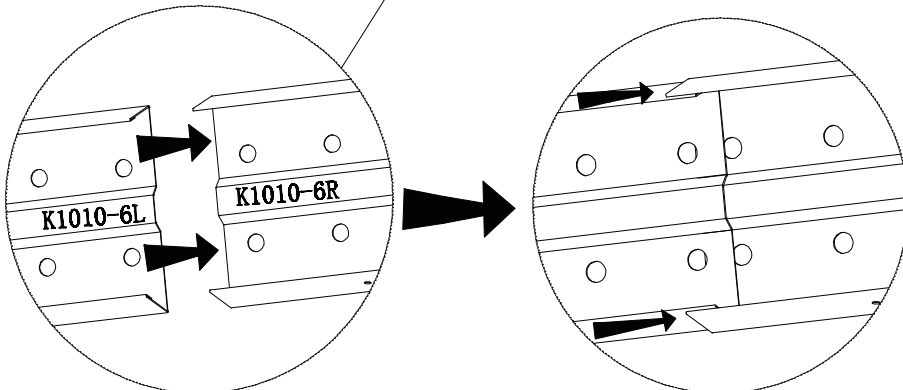
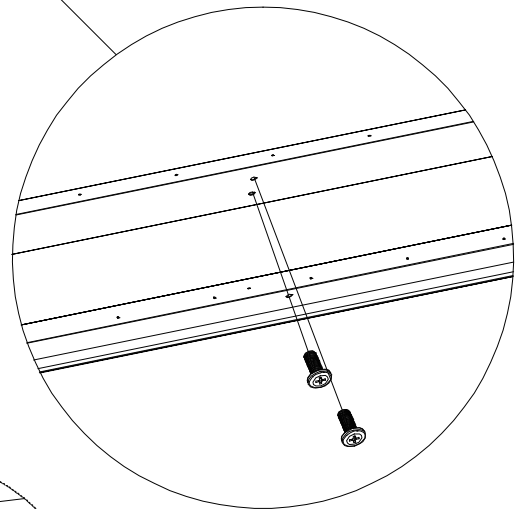
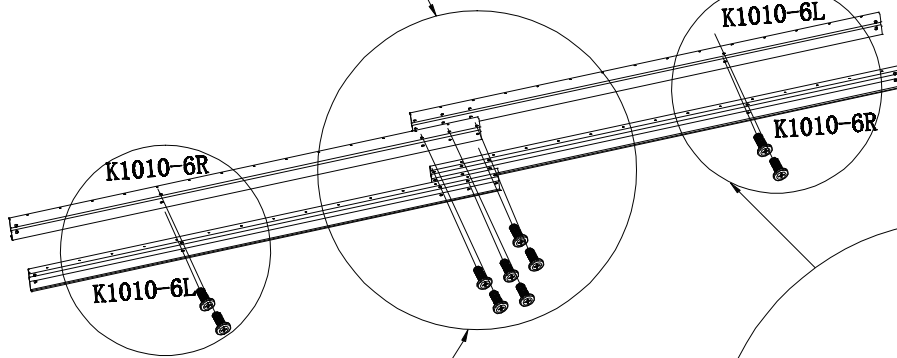
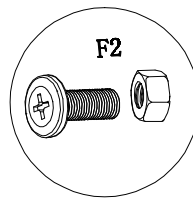
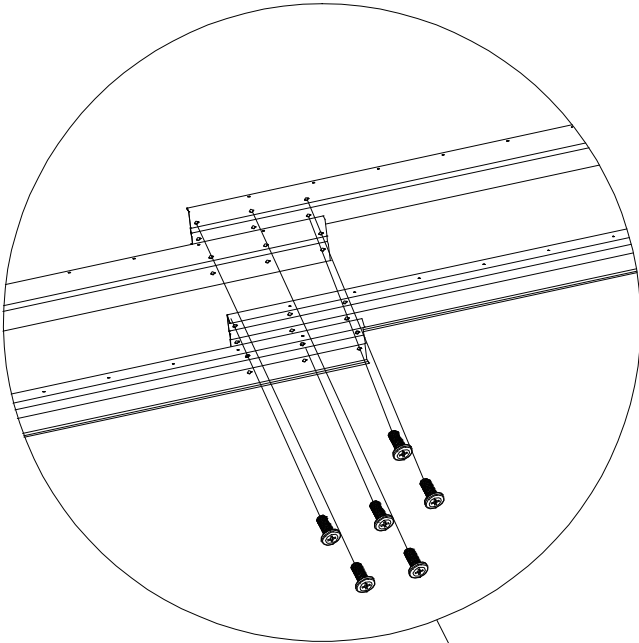

TCH7

PART	NO.	QTY.
	K1010-6L	2
	K1010-6R	2
	F2	10



PART	NO.	QTY.
	K1010-6L	2
	K1010-6R	2
	F1	8
	F2	16

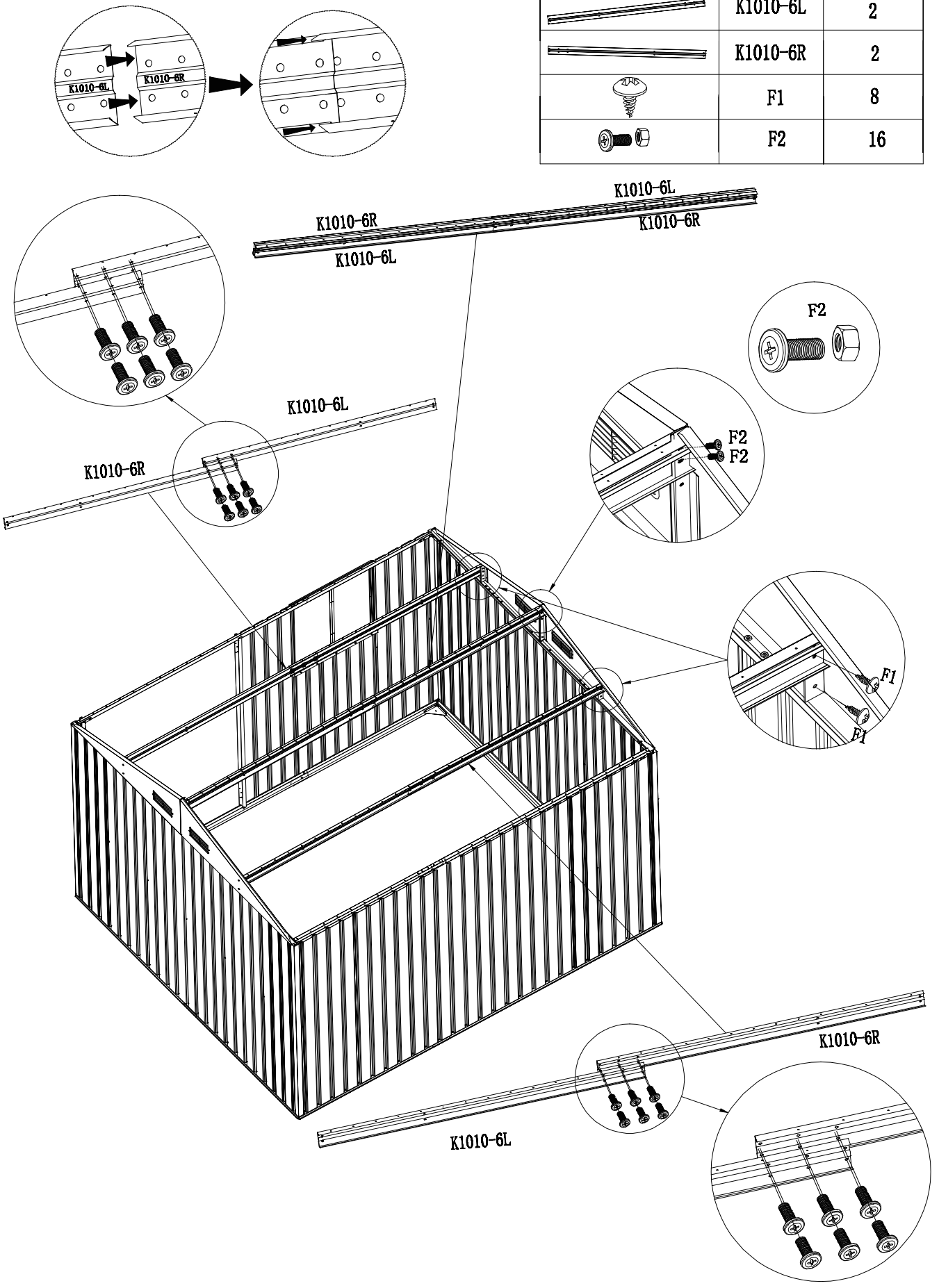



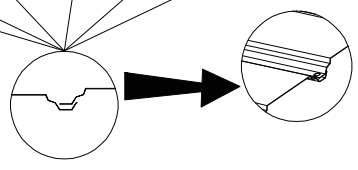
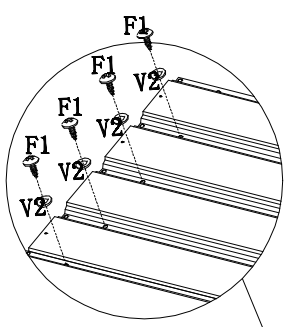

F810-7R F810-7M F810-7M F810-7M F810-7M F810-7M F810-7L

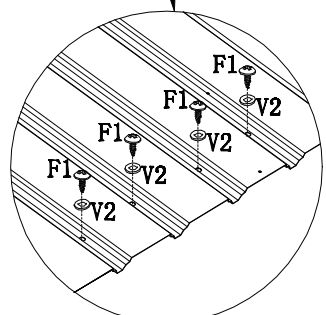
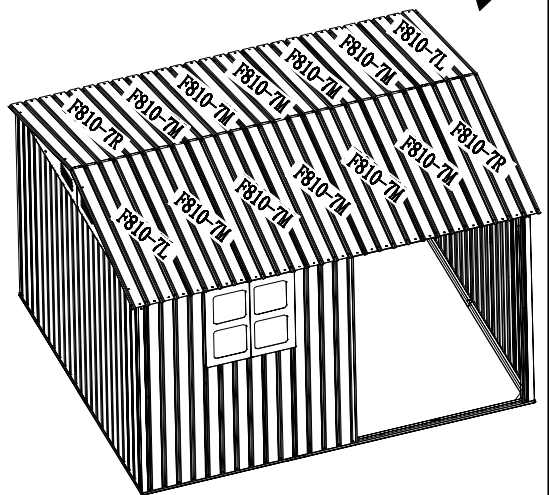
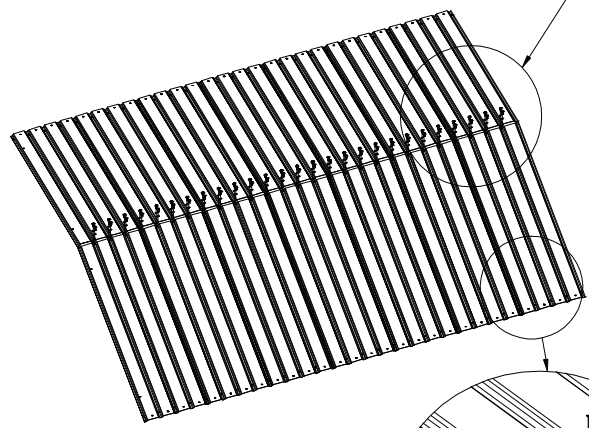
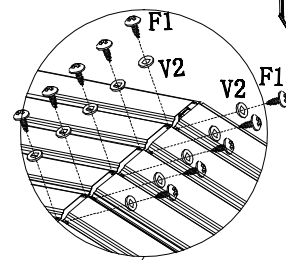
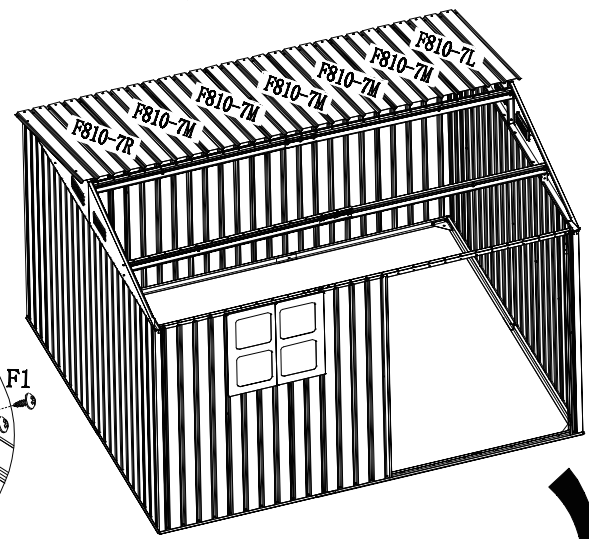
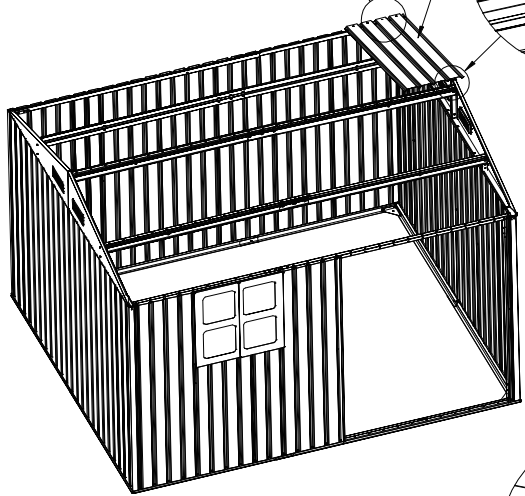
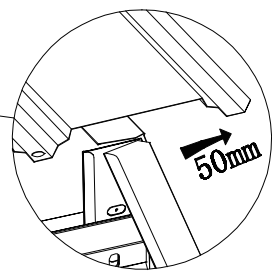
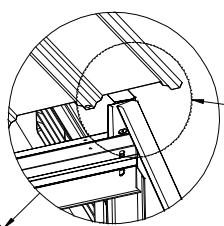

**!** Please steady the ladder make sure the product placed on a flat ground.



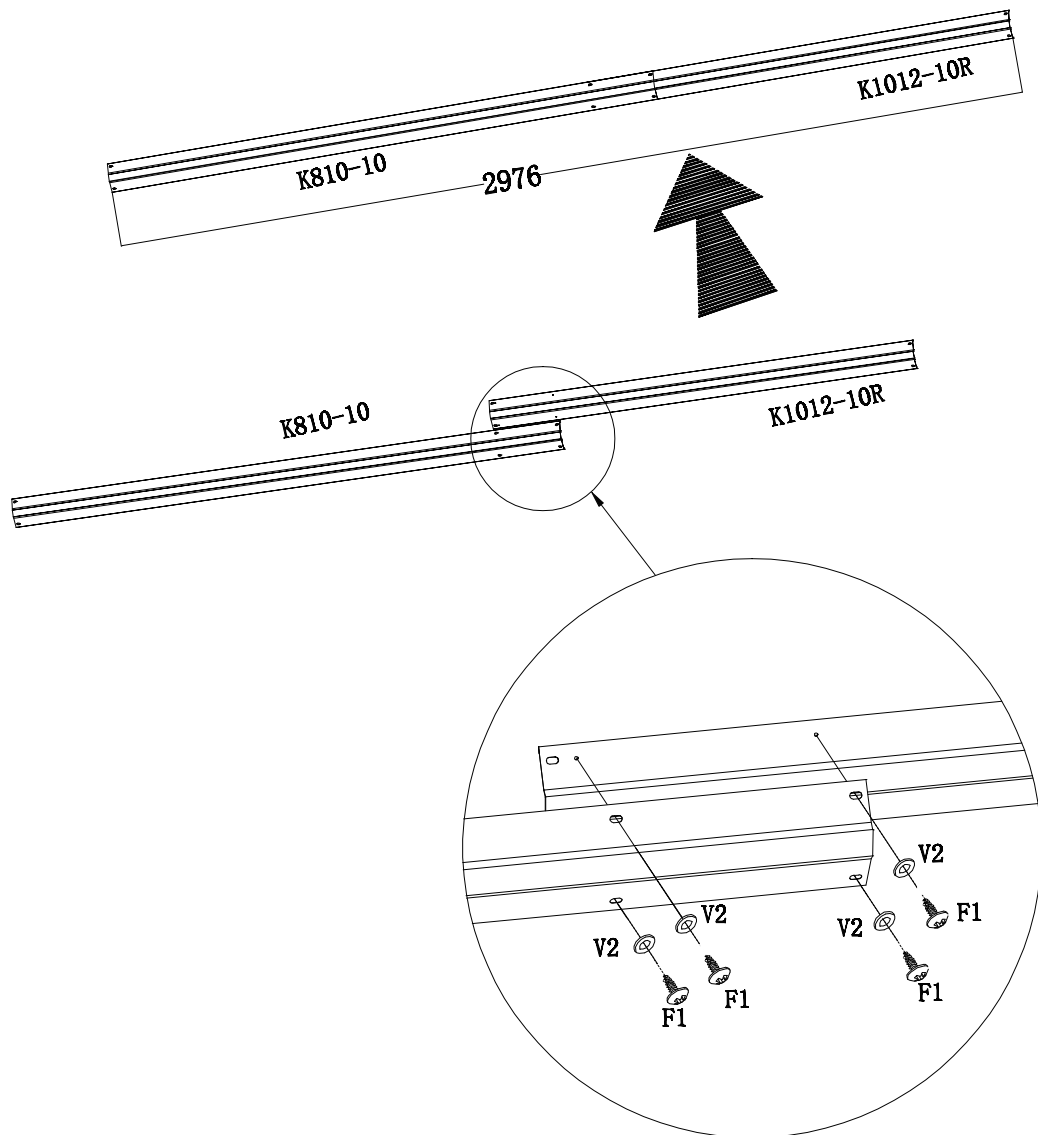

PART	NO.	QTY.
	F810-7L	2
	F810-7M	10
	F810-7R	2
	F1	108
	V2	108

PART	NO.	QTY.
	K810-10	1
	K1012-10R	1
	F1	4
	V2	4









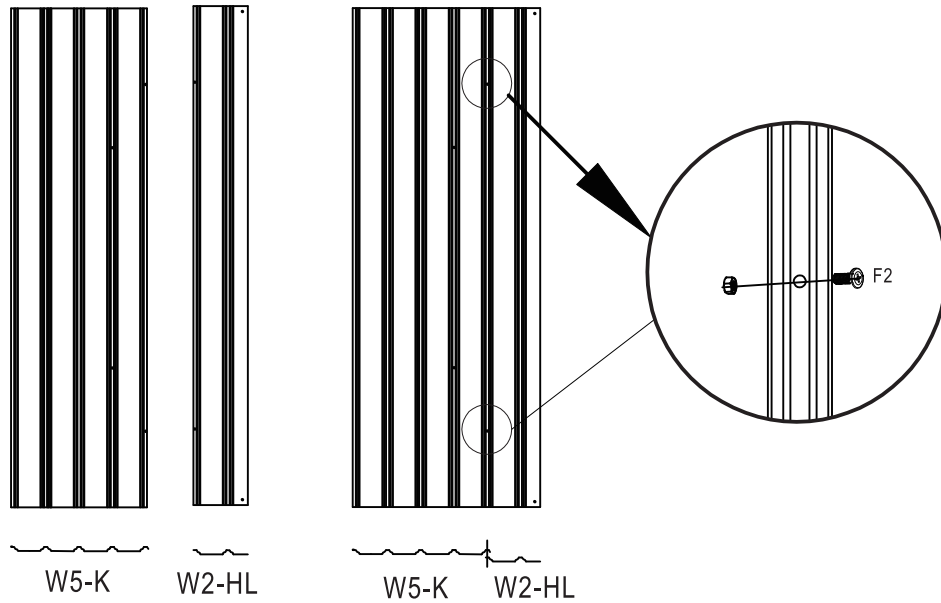

# Door Assemble

PART	NO.	QTY.
	W5-K	1
	W2-HL	1
	F2	2

**DL**



View from the front, the vertical rod covers the horizontal rod. The larger hole is always covered over the small hole.

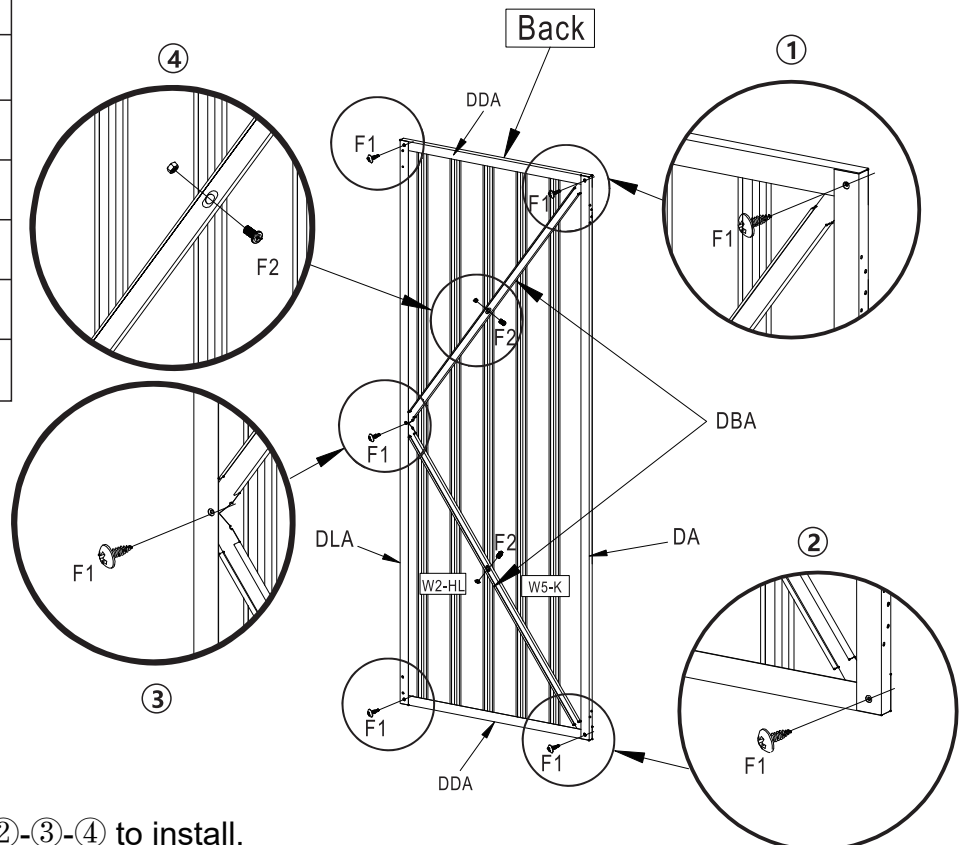

PART	NO.	QTY.
	DA	1
	DLA	1
	DDA	2
	DBA	2
	F1	9
	F2	2







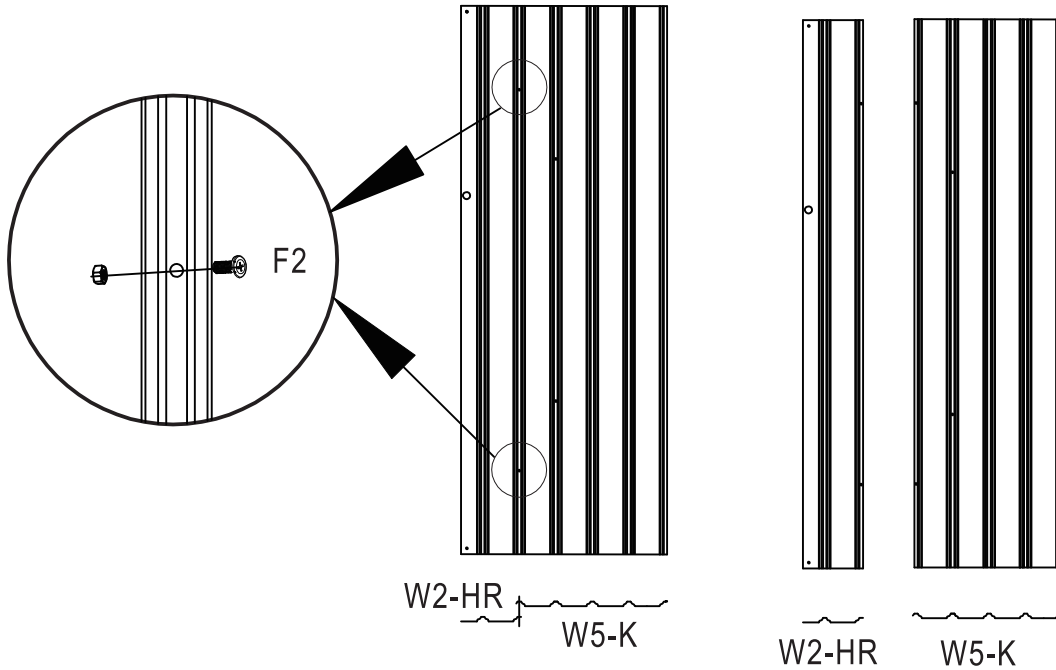

Please follow the steps ①-②-③-④ to install.  
The final fixation should be done after all parts are aligned.

PART	NO.	QTY.
	W5-K	1
	W2-HR	1
	F2	2

**DR**





View from the front, the vertical rod covers the horizontal rod.  
The larger hole is always covered over the small hole.

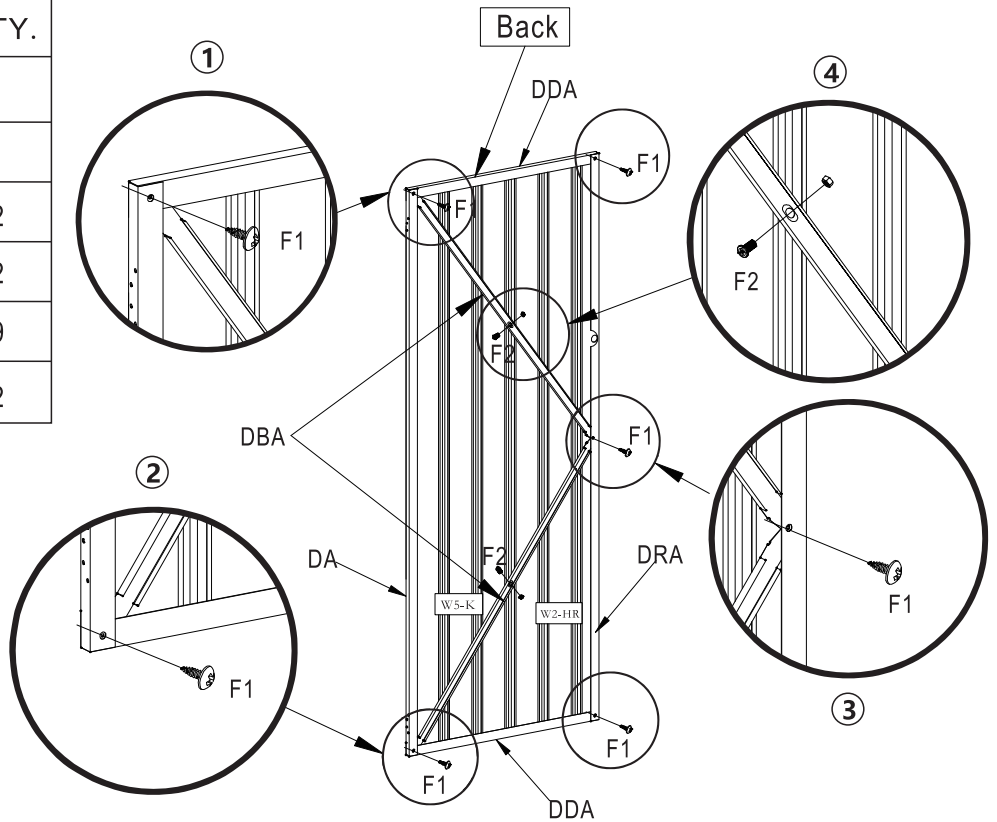





PART	NO.	QTY.
	DA	1
	DRA	1
	DDA	2
	DBA	2
	F1	9
	F2	2



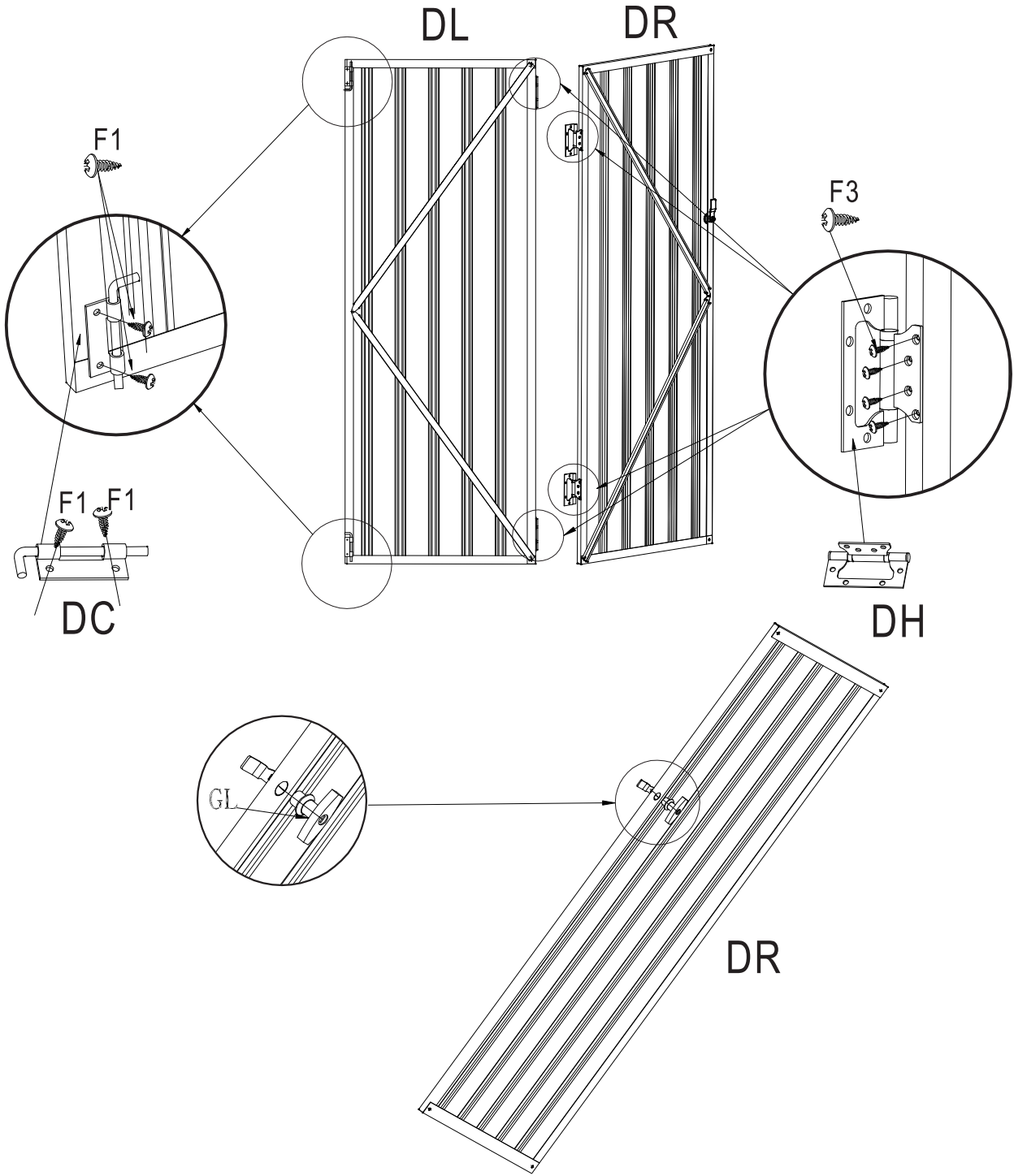

Please follow the steps ①-②-③-④ to install.  
The final fixation should be done after all parts are aligned.

PART	NO.	QTY.
	DH	4
	DC	2
	F3	16
	GL	1
	F1	4



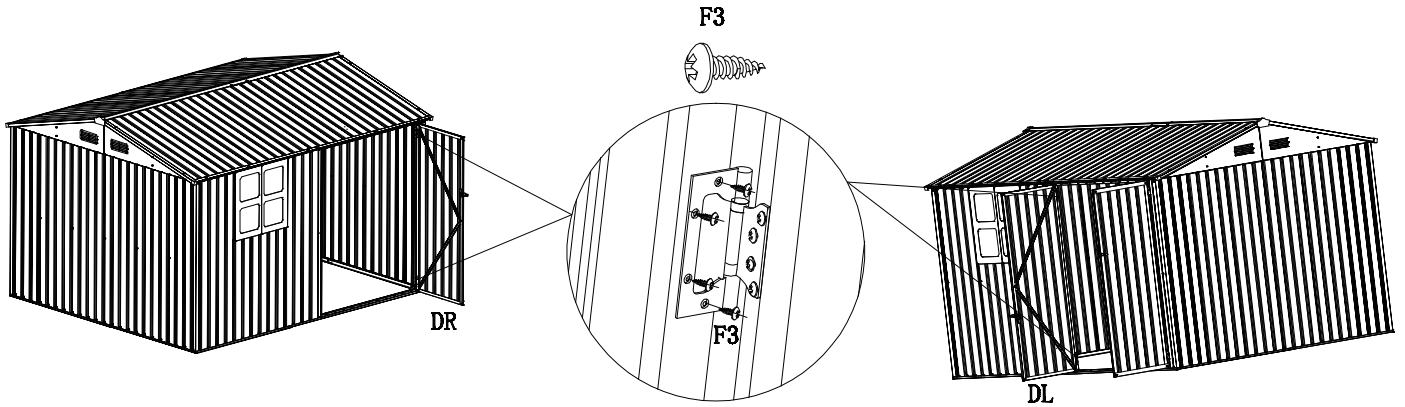

PART	NO.	QTY.
	DL	1
	DR	1
	F3	16

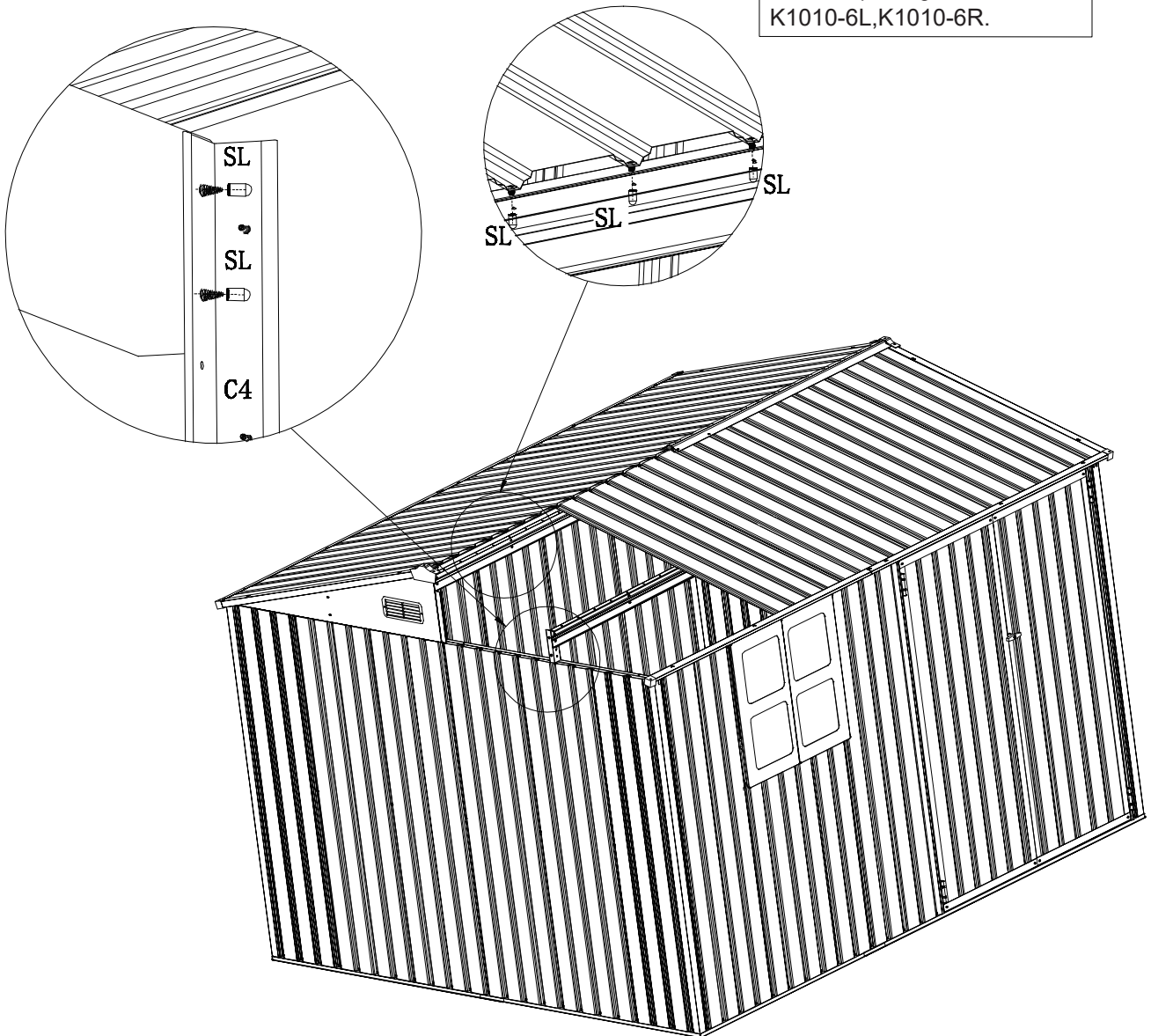

PART	NO.	QTY.
	SL	62

Install protective caps SL for those exposing screws on K1010-6L,K1010-6R.



PART	NO.	QTY
	LED	1
	3M Adhesive	1

Remove the back sticker of the 3M adhesive strip and attach the soft magnetic glue to the back of the LED.

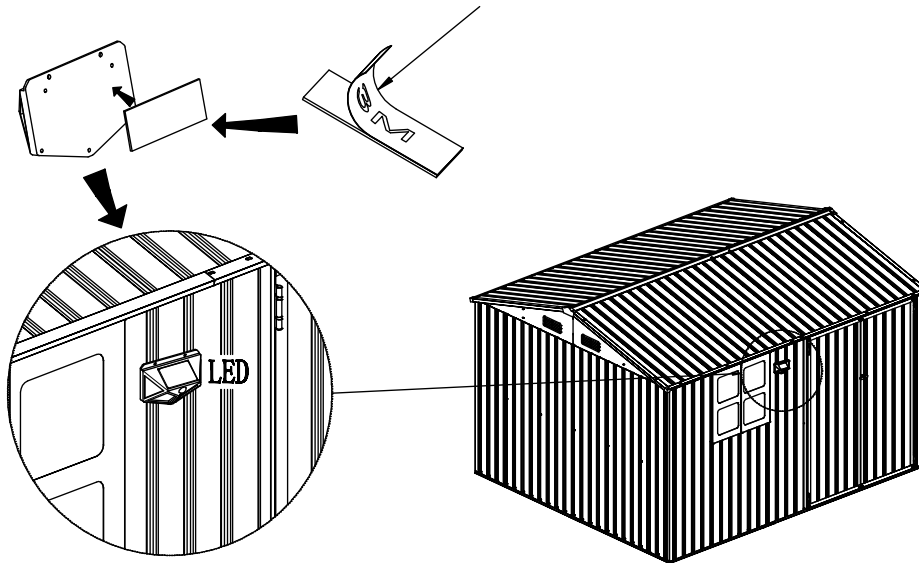

Please refer to the instructions in the box for specific instructions on the LED.

# HELP CENTER

Question about your product? We're here to help. Visit us at:

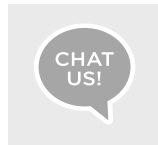

[Chat Support](#)

[Product Inquiry](#)

[Orders FAQ](#)

[Product Assembly](#)

[Returns & Refunds](#)

## We Stand Behind the Quality of Their Furniture

If you have any issues with your item please let us know! We will always do our best to come up with a solution that you will be happy with. Please get in touch with our customer service team before returning the product. And pls do not throw the original box(es) if you have not finished assembling or confirmed no quality issues.

Length of return period:

Items can be returned within 30 days of purchase.

In the meanwhile, everything you purchased from us comes with a one-year warranty.

Who is responsible for the return shipping fee:

We will cover the return shipping fees if:

1. Your item has a manufacturing defect in its materials or workmanship. For example, torn wicker or misaligned screw holes. We will send you a prepaid shipping label after photos are sent.
2. Your item has been damaged in transit. For example, glass is broken or wicker is damaged. We will send you a prepaid shipping label after photos are sent.
3. You receive the wrong box(es) due to a warehouse error. We will send you a prepaid shipping label after photos are sent of the wrong SKU numbers on the outer box(es).
4. One or more boxes are lost in transit. We will send you a prepaid shipping label if you no longer want the item.

\*However, we still hope to work with you for a better solution instead of a return. Please don't hesitate to contact our customer service team.

Customer will cover the return shipping fees if:

1. You don't like the product(s) after receiving the box(es).
2. You no longer need the product(s) but you have received the box(es).
3. You buy the product(s) by mistake but you have received the box(es).
4. Order/shipment cancellation failed and you have received the box(es).

---

## Return Request

In order to get a full refund as described in this return policy, all items must be: (1) In a brand new/unused condition, please provide photos before and after packaging. (2) When returning, all accessories and parts are firmly packed in all original packaging.

If your return does not meet the requirements, you may not get a full refund.

When will I be refunded?

The refund is released once the goods have been returned to our warehouse.

What if the product is damaged/defective outside of the valid return period?

We want you to be a happy customer. Please reach out to us by email and we will come up with a solution to make sure you are satisfied.

## Reach us at

 [support@garvee.com](mailto:support@garvee.com)