

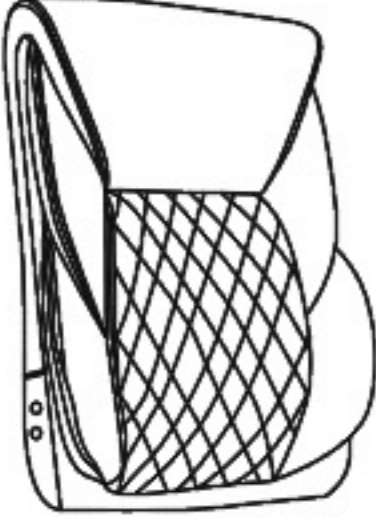







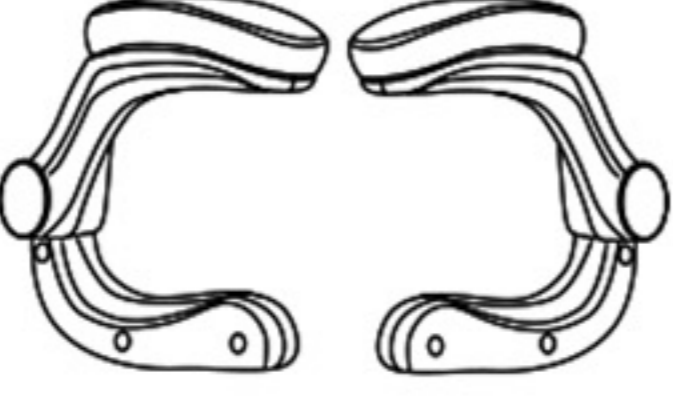
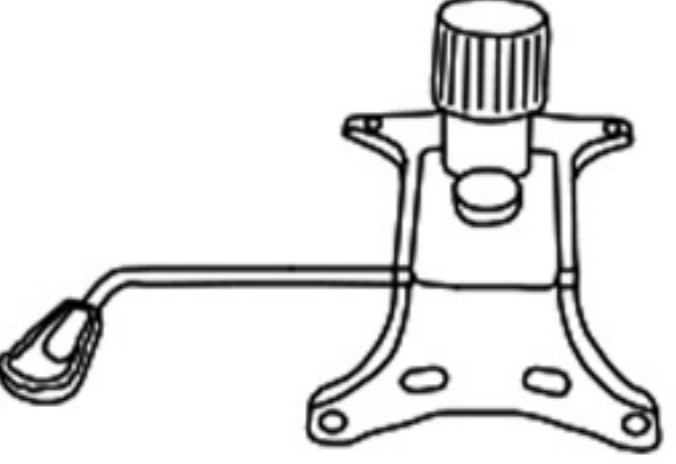

Accessories List

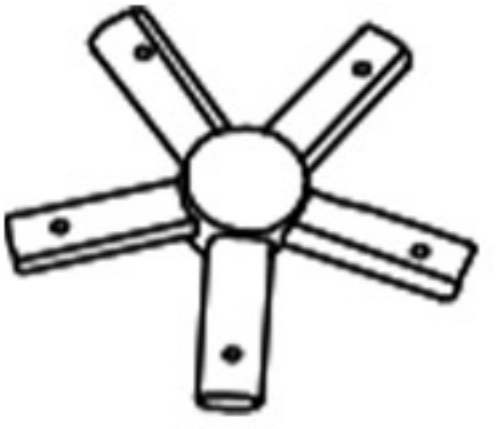
(1) Backrest 	(2) Seat Cushion 	(3) 2 Armrests 	(4) Base Plate 
(5) Split Base Tube 	(6) Central Base Tube 	(7) Central Base Buckle 	(8) Air Rod 
(9) 5 Castors 	(10) Hexagon Wrench 	(11) 8 Decoration Caps 	(12) 5 Screws (M6×20) 
(13) 8 Screws (M8×25) 	(14) 4 Screws (M6×25) 		

Notice

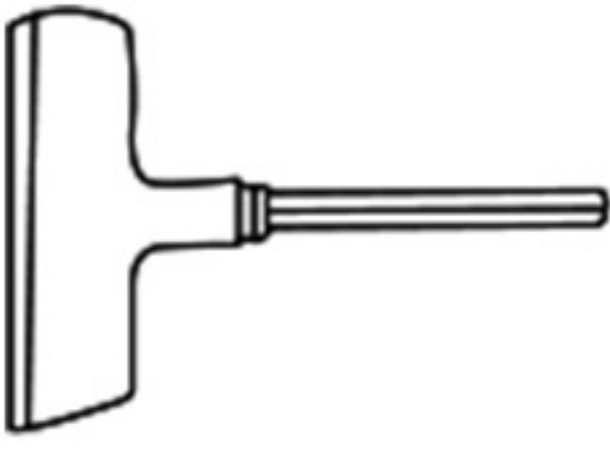
- Do not stand in this chair or use the chair as a step ladder, use it as chair only. This chair is designed for one person to use at a time.
- Do not use this chair unless all bolts, screws and knobs are firmly secured.
- Check all bolts, screws and knobs every 6 months. Tighten if any are loose.
- Failure to follow these instructions may result in serious injury or death of yourself and people around you.
- Some of the parts are heavy and/or have sharp edge, please install it carefully to avoid hurting you and people around you.

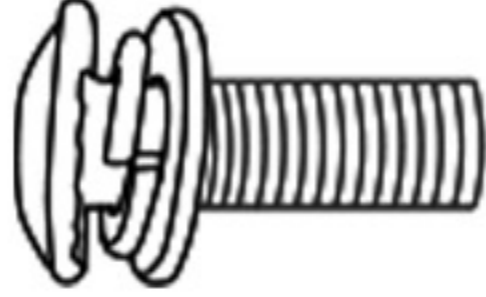
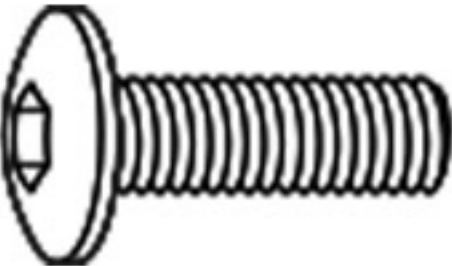
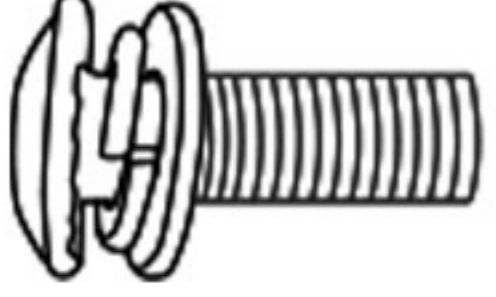
Instructions for Use



Upward/Downward adjustment



Armrest adjustment



115° Rocking function

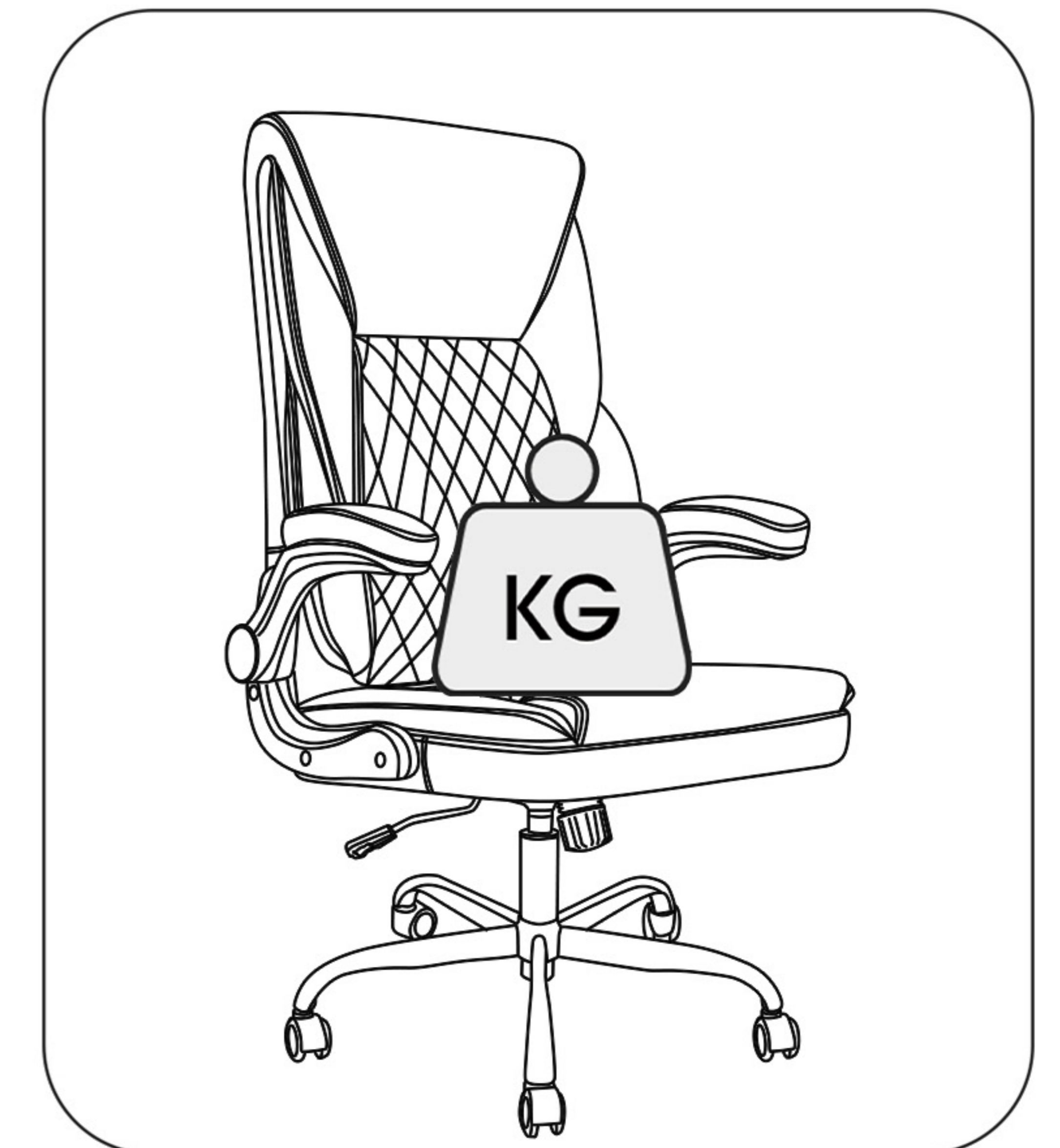

300LB (136kg)

Thanks for purchasing our products. Please read this manual before assembly. And please assemble in order. After the assembly, keep the instruction properly. Make sure all the parts are included (14 kinds in total).

Assembly Instruction

Step 1

Take out Split Base Tube (5), Central Base Tube (6). Insert Split Base Tube (5) into Central Base Tube (6) as shown. You can see there are screw holes. Align with the holes, tighten Screws M6X20 (12) with Hexagon Wrench (10) to fix 5 Split Base Tube (5) to Central Base Tube (6). Repeat it five times.

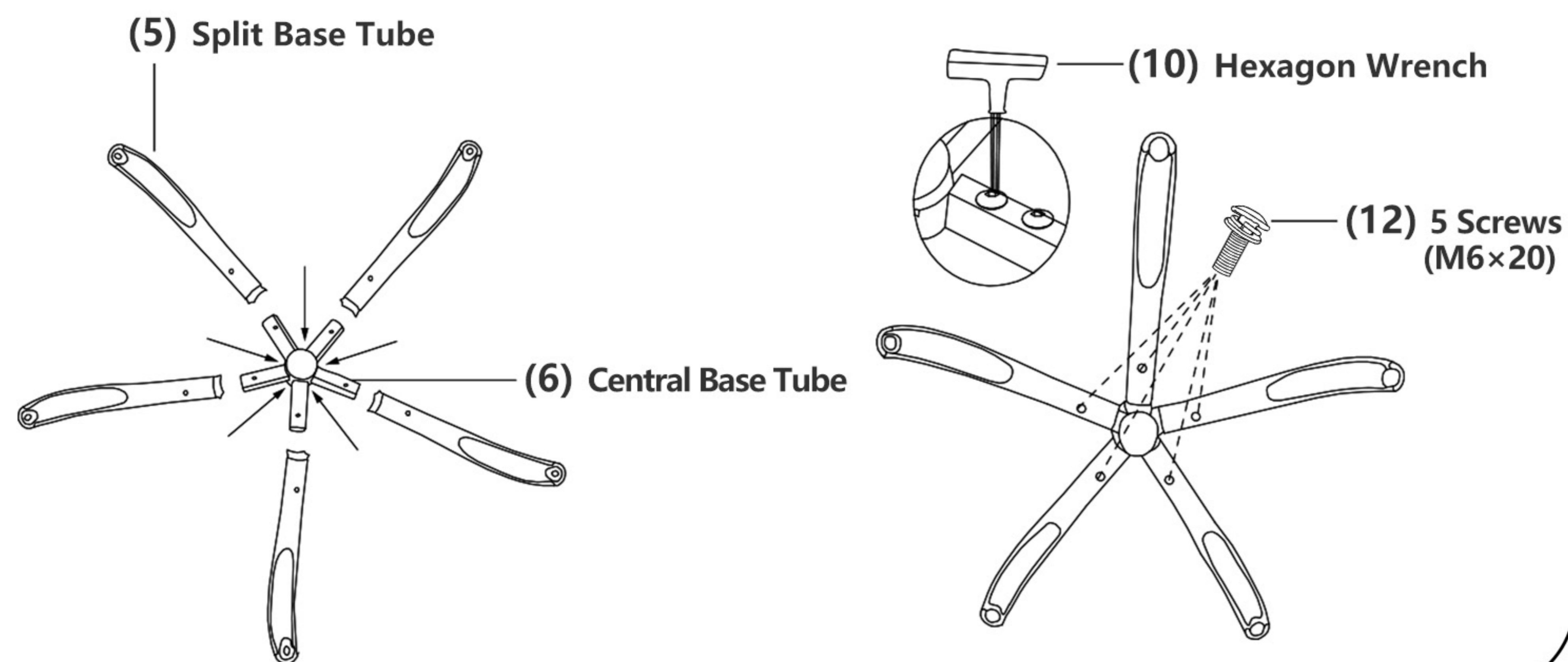

Step 2

Take out Castors (9). Insert Castors (9) into part of Step 1 as shown. There are 5 Castors (9) need to be inserted. Take out Air Rod (8). Put Air Rod (8) through Central Base Buckle (7) into the hole of Central Base Tube (6) as shown.

* Caution: Confirm 5 Castors (9) must be inserted deeply. Otherwise the castors could easily fall out and the chair could fall down.

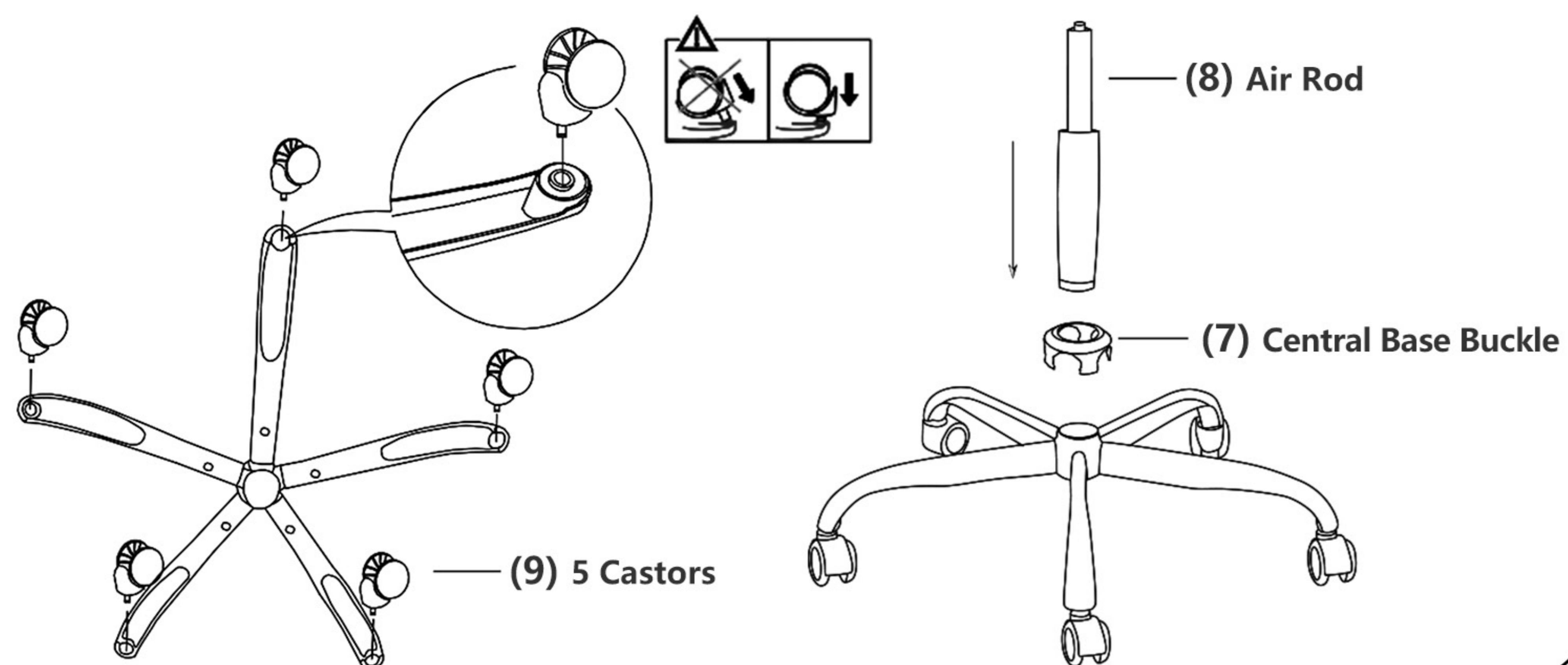

Step 3

Fix Base Plate (4) to the bottom of Seat Cushion (2). Tighten the Screws M6X25 (14) with Hexagon Wrench (10) firmly. Then insert the Air Rod (8) into the Base Plate (4), the Base Plate (4) has holes in the middle. Press the Seat Cushion (2) from top to bottom, with all the strength of your body.

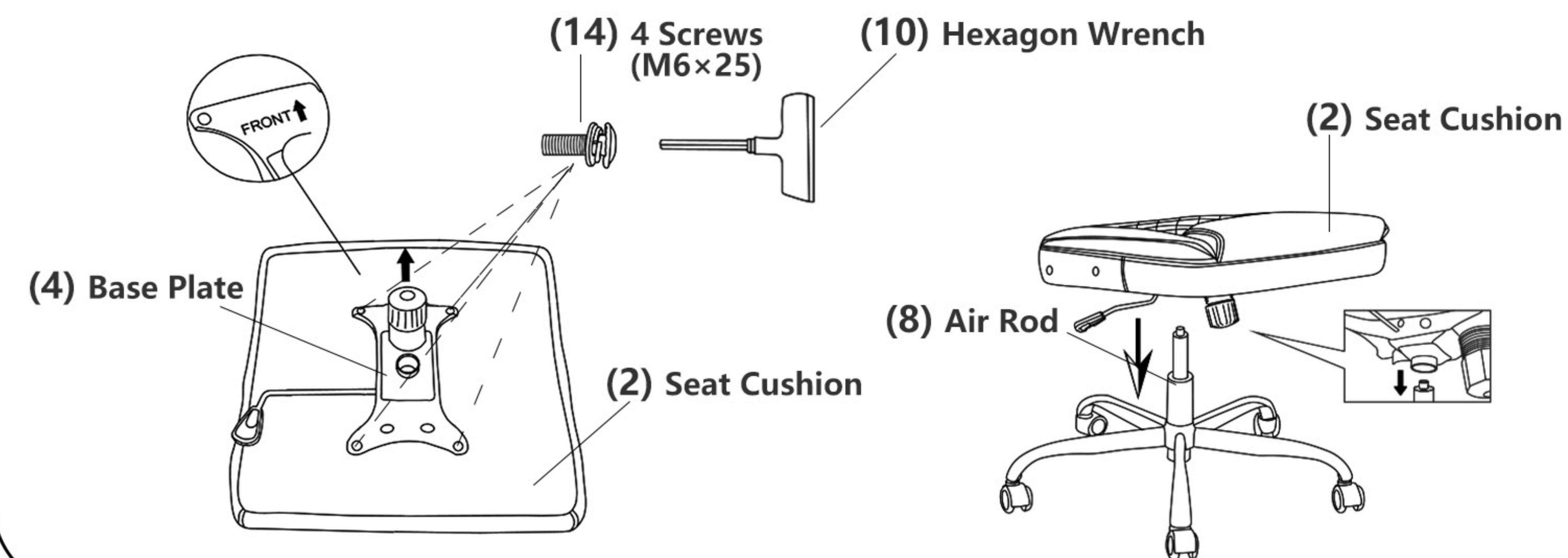

Step 4

Tighten the Screw M8X25 (13) with a Hexagon Wrench (10) to fix the 2 Armrests (3) on the Seat Cushion (2). Then fix the Backrest (1) between the 2 Armrests (3) and the Seat Cushion (2) with Screw M8X25 (13). Tighten the 8 screws firmly and then screws with 8 Decoration Caps (11). The assembly is complete now.

* Caution: Do not tighten the bolts before the product is fully assembled.

* Caution: Tighten the 8 Screws firmly and then cover the Screws with Decoration Caps (11). The assembly is complete now.

