

# ANKA PLAY TABLE AND CHAIR SET (1+2) ASSEMBLY INSTRUCTION

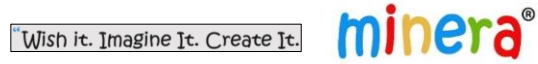

## CONTENTS

TABLE			CHAIR		
NR.	Component	Qty	NR.	Component	Qty
1	Case Long Side Piece	2	8	Seat Tray	2
2	Case Short Side Piece	2	9	Back	2
3	5 mm Table Bottom Board	1	10	Left Part	2
4	Flat Table Leg	2	11	Right Part	2
5	Table Leg	2	12	Bottom Unit	2
6	Sub Support Unit	2	-	Fastening Screw	16+1 (Add.)
7	8 mm Table Top	1			
-	Long Mounting Screw	16+1 (Add.)			
-	Short Mounting Screw	4+1 (Add.)			

**THE PRODUCT SHOULD NOT COME INTO CONTACT WITH WATER. WIPE WITH A CLOTH WITH A SMALL AMOUNT OF MILD DETERGENT. DRY WITH A CLEAN CLOTH.**



**\*IMPORTANT NOTE: TIGHTEN THE SCREWS HALFWAY WHILE ASSEMBLING THE PARTS AND FULLY TIGHTEN THEM AFTER THE ASSEMBLY WORKS ARE COMPLETED!**

## WARNINGS

- \*THERE IS A RISK OF SUFFOCATION DUE TO SMALL PARTS (SCREWS ETC.).
- \*MUST BE USED UNDER PARENTAL SUPERVISION.
- \*ASSEMBLY MUST BE DONE BY ADULTS. TO BE ASSEMBLED MANUALLY WITH SCREWDRIVER OR CORDLESS DRILL WITH LOW TORQUE.
- \*MAXIMUM (AVERAGE) CARRYING LOAD OF THE TABLE: 30 KG.
- \*MAXIMUM (AVERAGE) CARRYING LOAD OF THE CHAIR: 40 KG.
- \*THERE IS A RISK OF FALLING IN WEIGHTS GIVEN TO ONE SIDE IN THE SITTING POSITION ON THE CHAIR.
- \*THE TABLE MUST BE USED FOR ITS INTENDED PURPOSE AND MUST NOT BE OVERLAPPED.

**PLEASE USE A SCREWDRIVER FOR ASSEMBLY**

## CHAIR ASSEMBLY STEPS

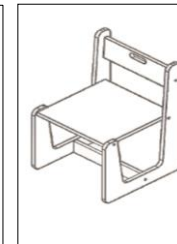
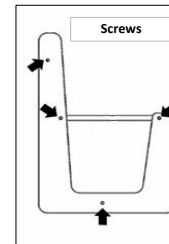
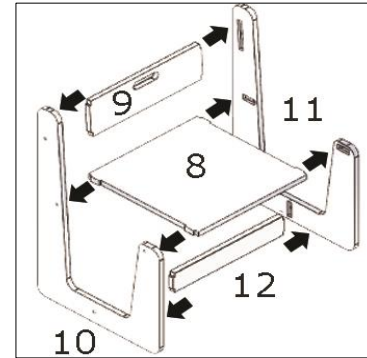

## Q&A ?

### PRODUCT SHAKES!!!:

- 1- Screws are not fully tightened.
- 2- Screws are tightened before the parts are fully seated.
- 3- Assembly of all parts is not complete.

### PART of the PRODUCT IS CRACKED!!!:

- 1- Cracks due to screwing from a place other than the screw places.
- 2- Screws are tightened before the parts are fully seated.

### PRODUCT ARRIVED BROKEN!!!:

- 1- Quality controlled products are packaged and shipped. It is damaged from time to time in cargo.
- 2- If any of the parts are broken, cracked, etc. if there is a deformation, the product has been damaged in the shipment.
- 3- If you have encountered such a situation, please call our technical support line before assembling and returning the product.

## TABLE ASSEMBLY STEPS

1- Start by collecting the top case of the table.

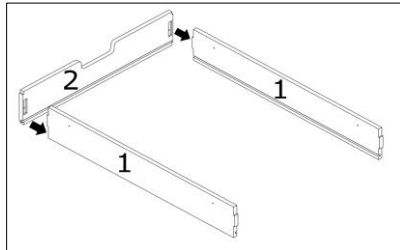

2- Assemble the 5 mm thick table bottom plate. Be careful not to mix with the 8 mm thick top plate.

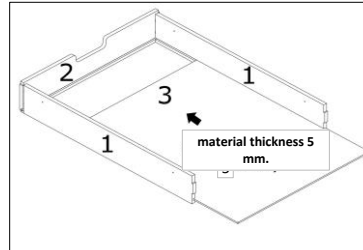

3- Assembled version of the table frame

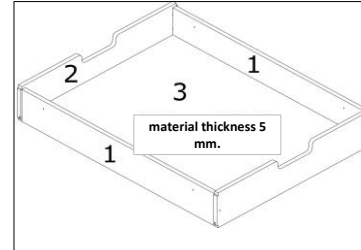

4- Continue by assembling the legs of the table.

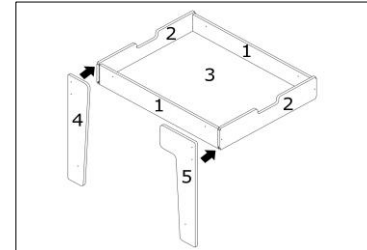

5- Assemble the bottom support records of the table.

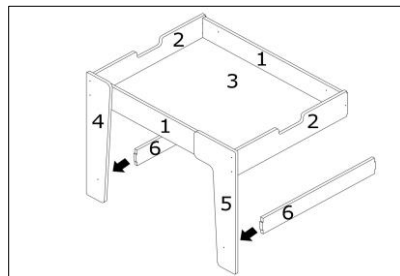

6- Complete the assembly of the table legs.

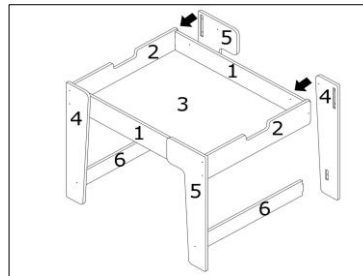

7- Perspective view of the assembled table

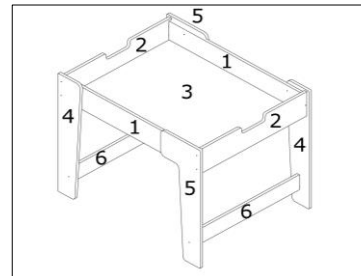

8- Thickness: 5 mm. Complete the assembly of the product by placing the top plate.

