

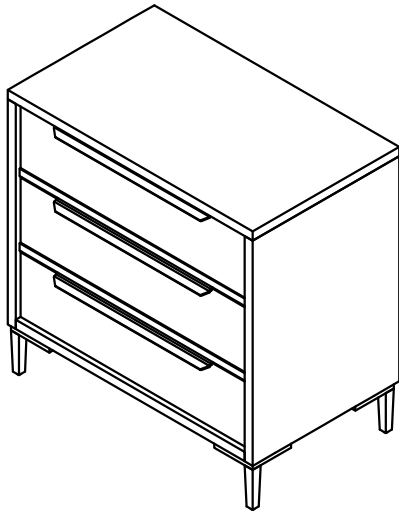

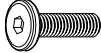

ASSEMBLY INSTRUCTION FOR 3 DRAWER DRESSER



Hardware List

A		Bolt	6mmx20mm	16
B		Spring Washer	6mm	16
C		Flat Washer	6mmx16mm	16
D		Allen Key	4mm	1
E		Tipping Hardware		1 set

Step 1

Align legs with frame before
tightening bolts

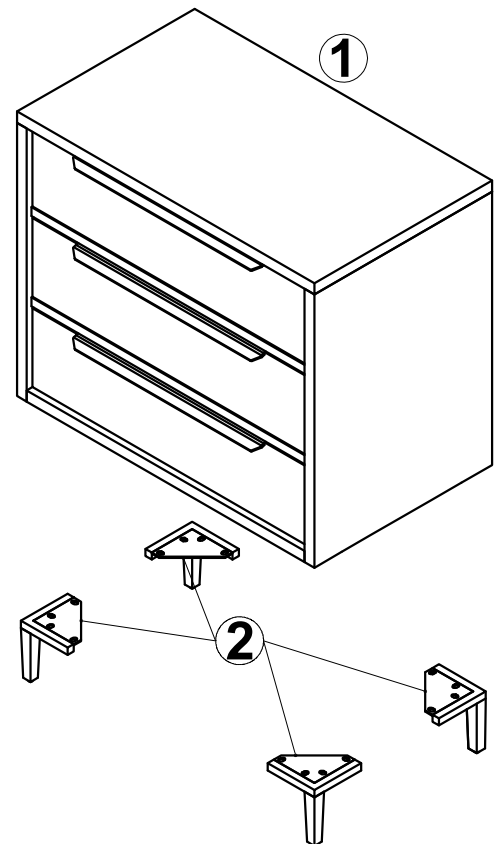
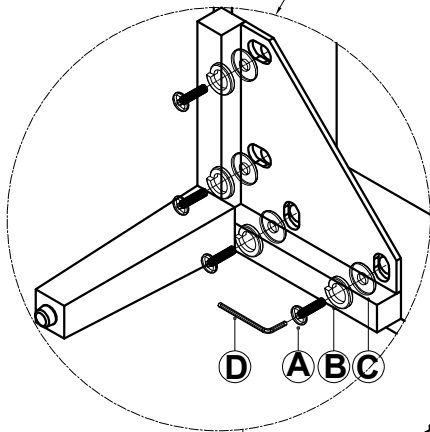

Step 2

REMARK: There is a tip restraint kit provided on the back of this product please read the direction thoroughly and install immediately

Tipping Hardware

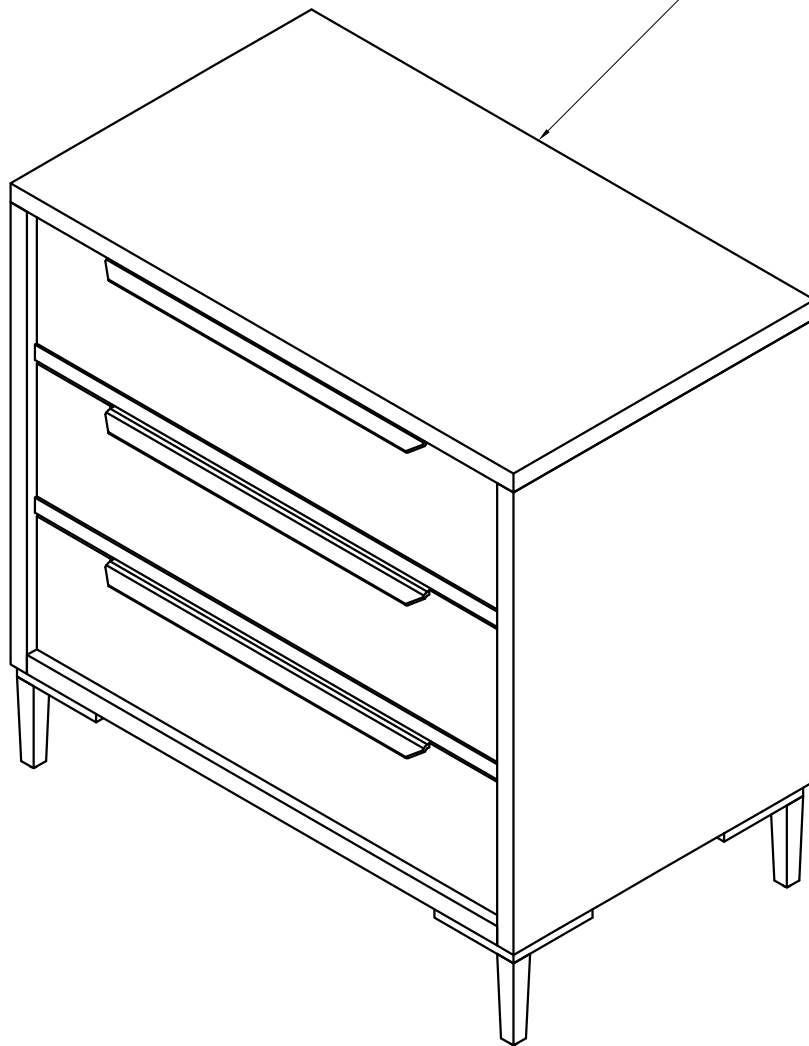
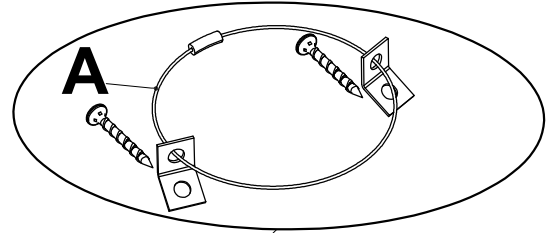

Step 3

Adjusting floor levelers.

Your furniture has been expertly crafted and re-adjusted by professionals. However, slight shifts can occur during transportation. If you notice that the furniture wobbles, a quick adjustment can help ensure stability and a seamless look.

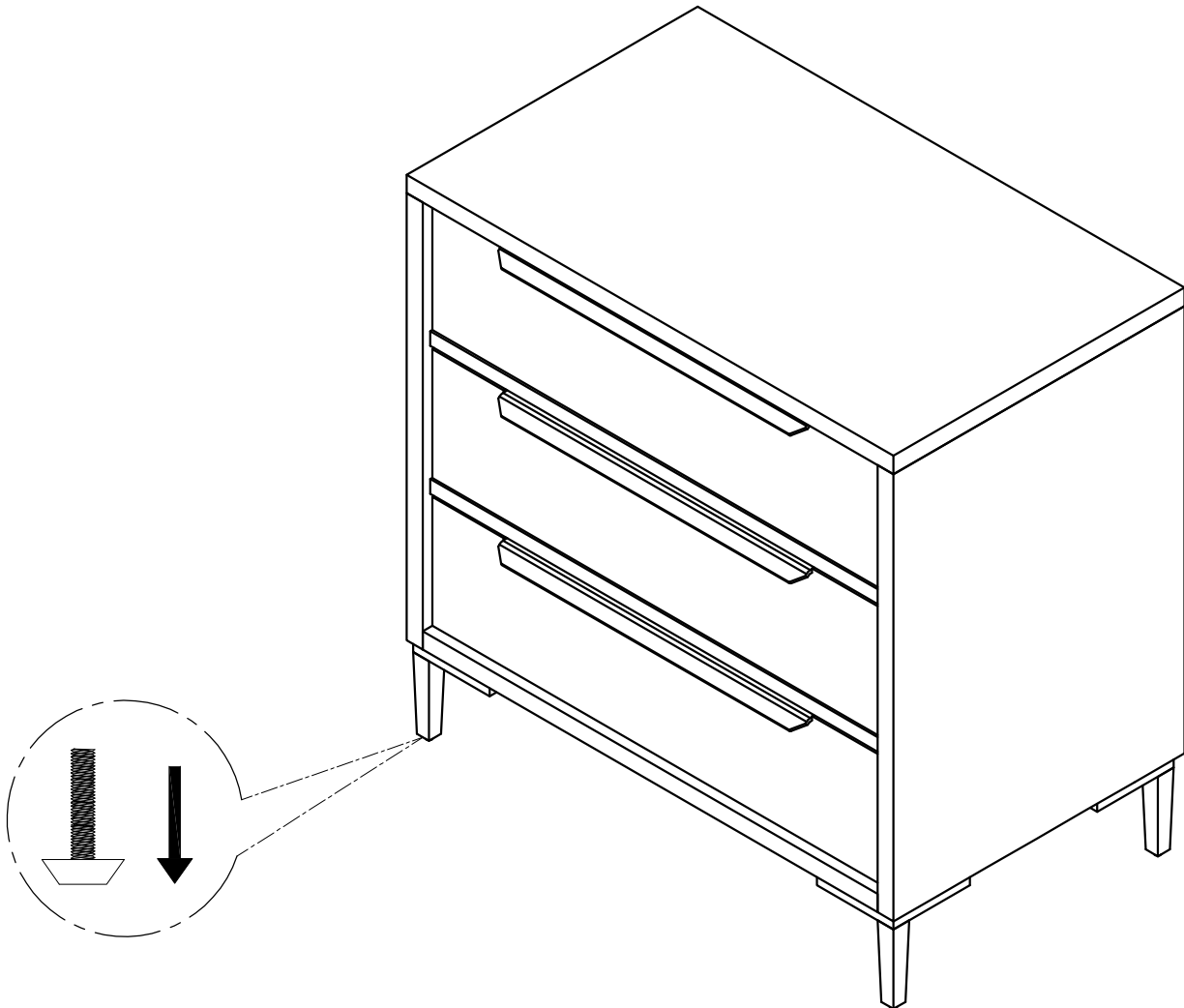

Adjusting Floor Levelers

Check for stability - Place the furniture in its final position on a level surface. If it wobbles or doesn't sit evenly, the floor levelers need adjusting.

Locate the levelers - These are small adjustable feet found at the bottom corners of your furniture.

Adjust as needed - Using your hand or a wrench, turn the levelers clockwise to raise or counterclockwise to lower the furniture. Make small adjustments and check stability after each turn.

If you need further adjustments, repeat the process in small increments.