

# Instruction Manual

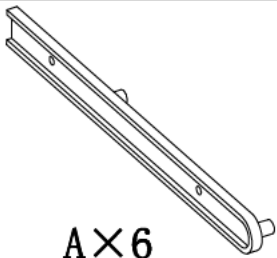

A×6

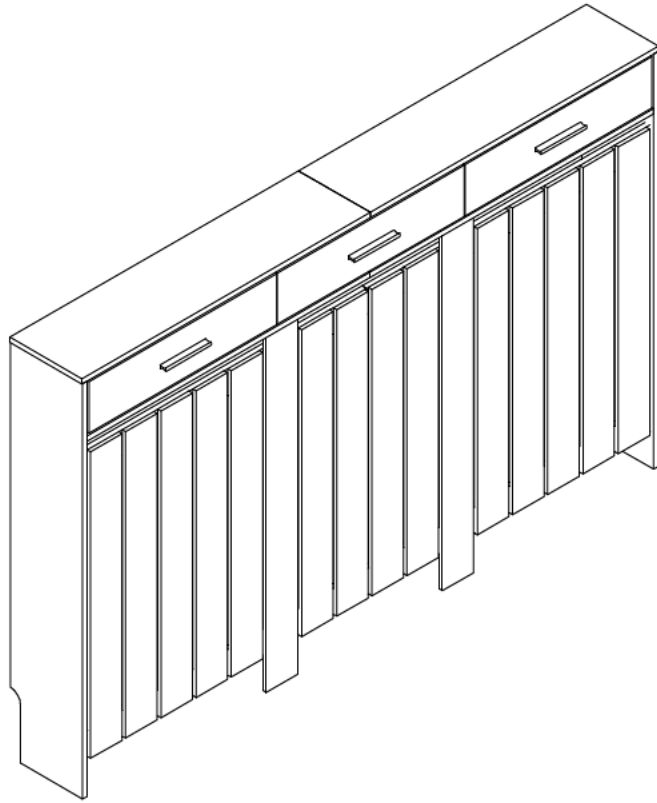
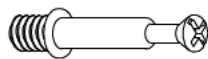

B×32



C×40



D×10

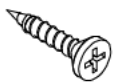

E×64



F×2

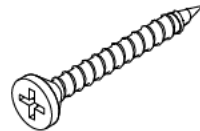

G×12

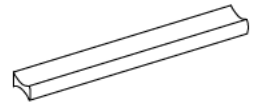

H×3



I×6



J×3

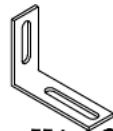

K×2



L×2



M×2



N×19



O×2

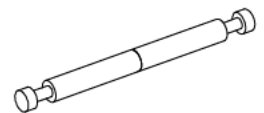

P×4

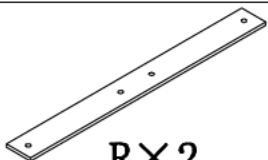

R×2

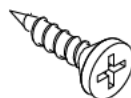

S×8

# Exploded View

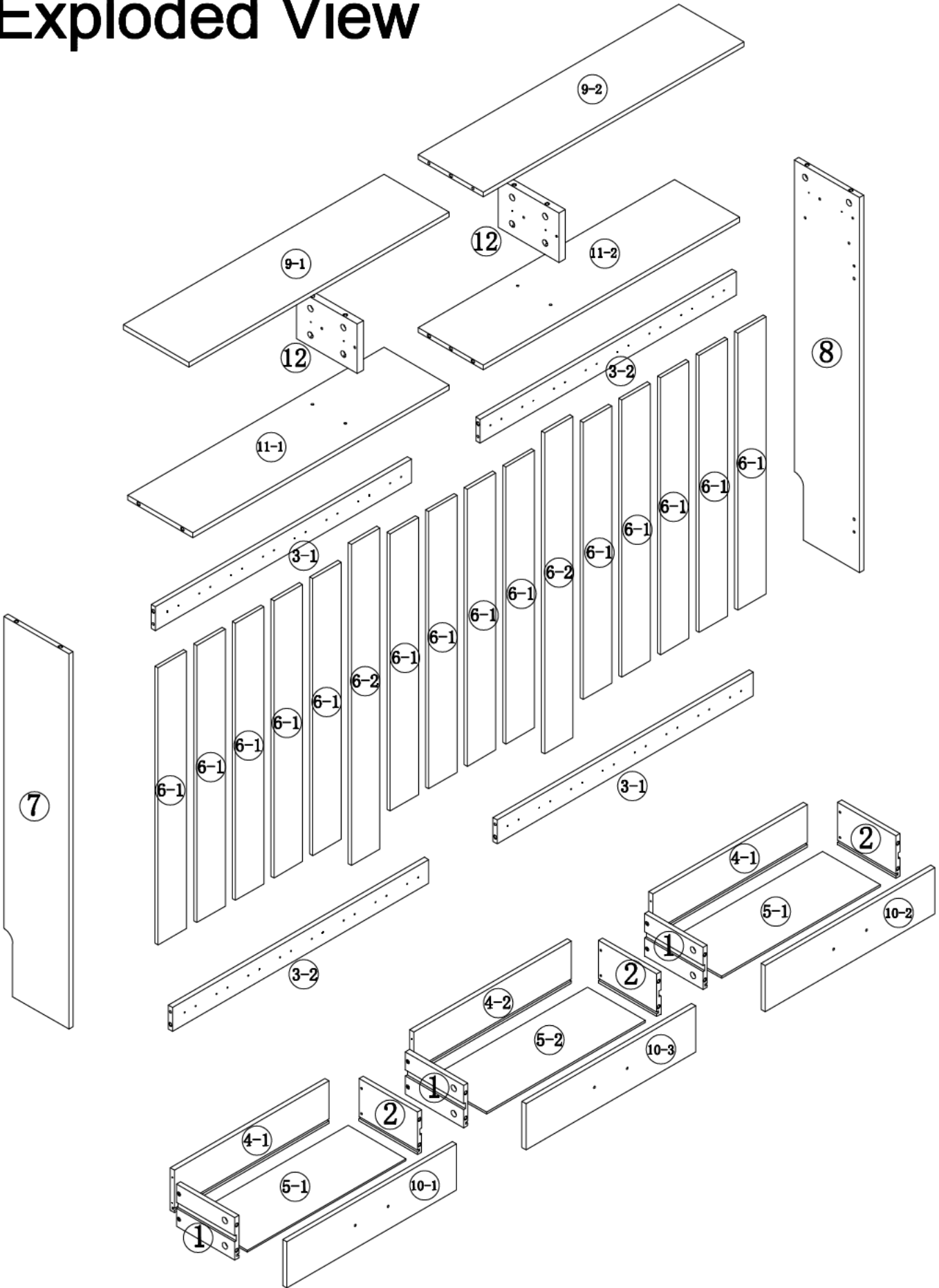

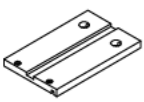
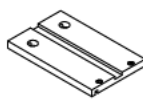
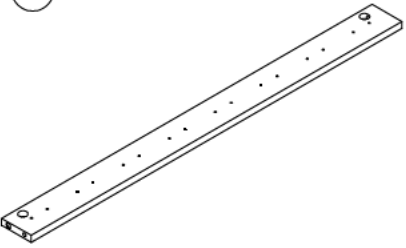
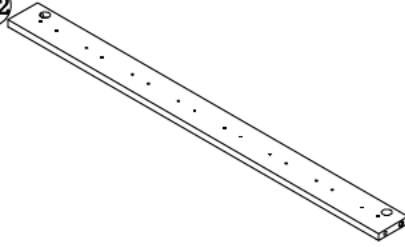
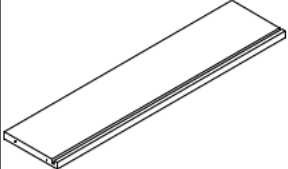
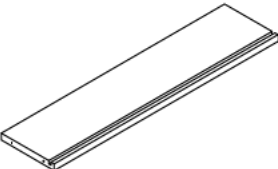
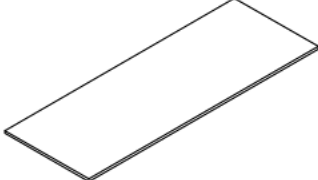
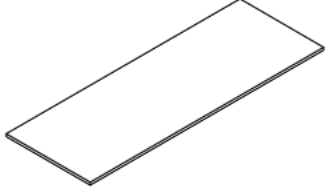
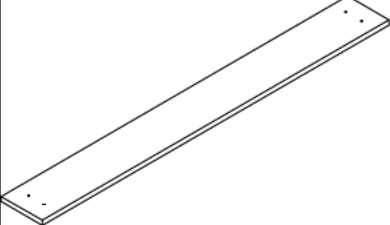
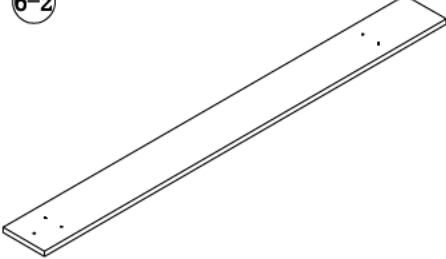
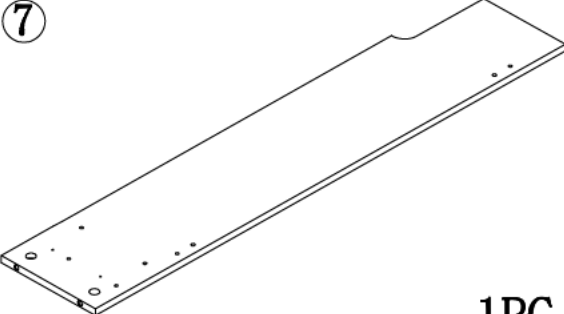
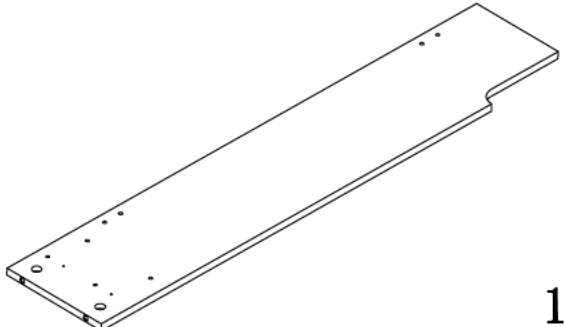
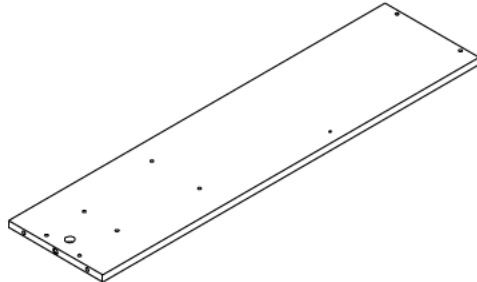
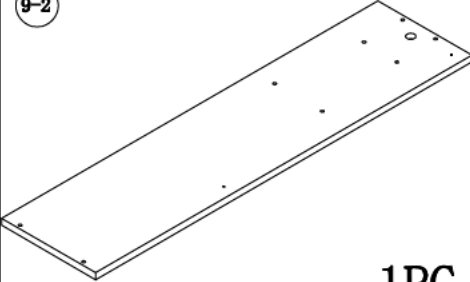
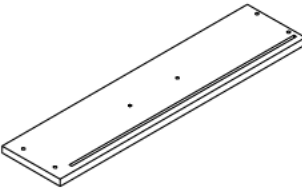
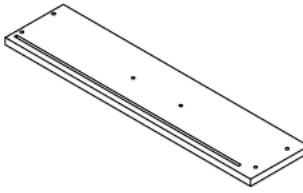
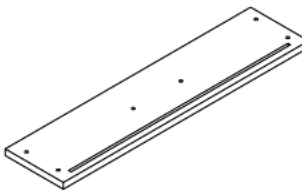
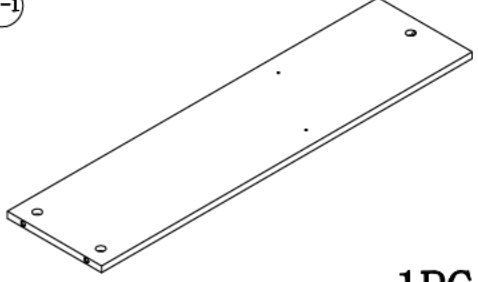
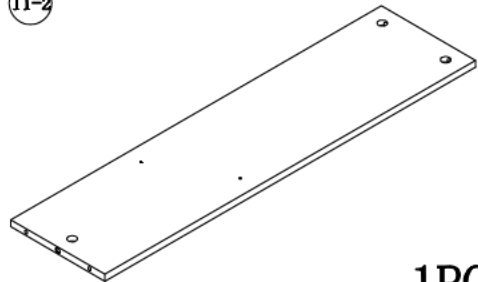
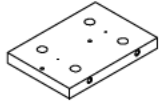
<p>①</p>  <p>3PCS</p>	<p>②</p>  <p>3PCS</p>	<p>③-1</p>  <p>2PCS</p>	<p>③-2</p>  <p>2PCS</p>
<p>④-1</p>  <p>2PCS</p>	<p>④-2</p>  <p>1PC</p>	<p>⑤-1</p>  <p>2PCS</p>	<p>⑤-2</p>  <p>1PC</p>
<p>⑥-1</p>  <p>14PCS</p>	<p>⑥-2</p>  <p>2PCS</p>	<p>⑦</p>  <p>1PC</p>	
<p>⑧</p>  <p>1PC</p>	<p>⑨-1</p>  <p>1PC</p>		
<p>⑨-2</p>  <p>1PC</p>	<p>⑩-1</p>  <p>1PC</p>	<p>⑩-2</p>  <p>1PC</p>	<p>⑩-3</p>  <p>1PC</p>
<p>⑪-1</p>  <p>1PC</p>	<p>⑪-2</p>  <p>1PC</p>	<p>⑫</p>  <p>2PCS</p>	

# STEP1

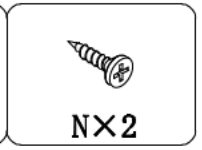
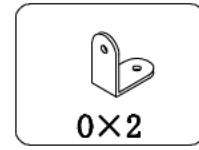
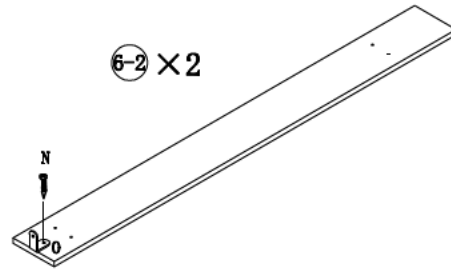

# STEP2

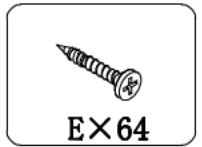
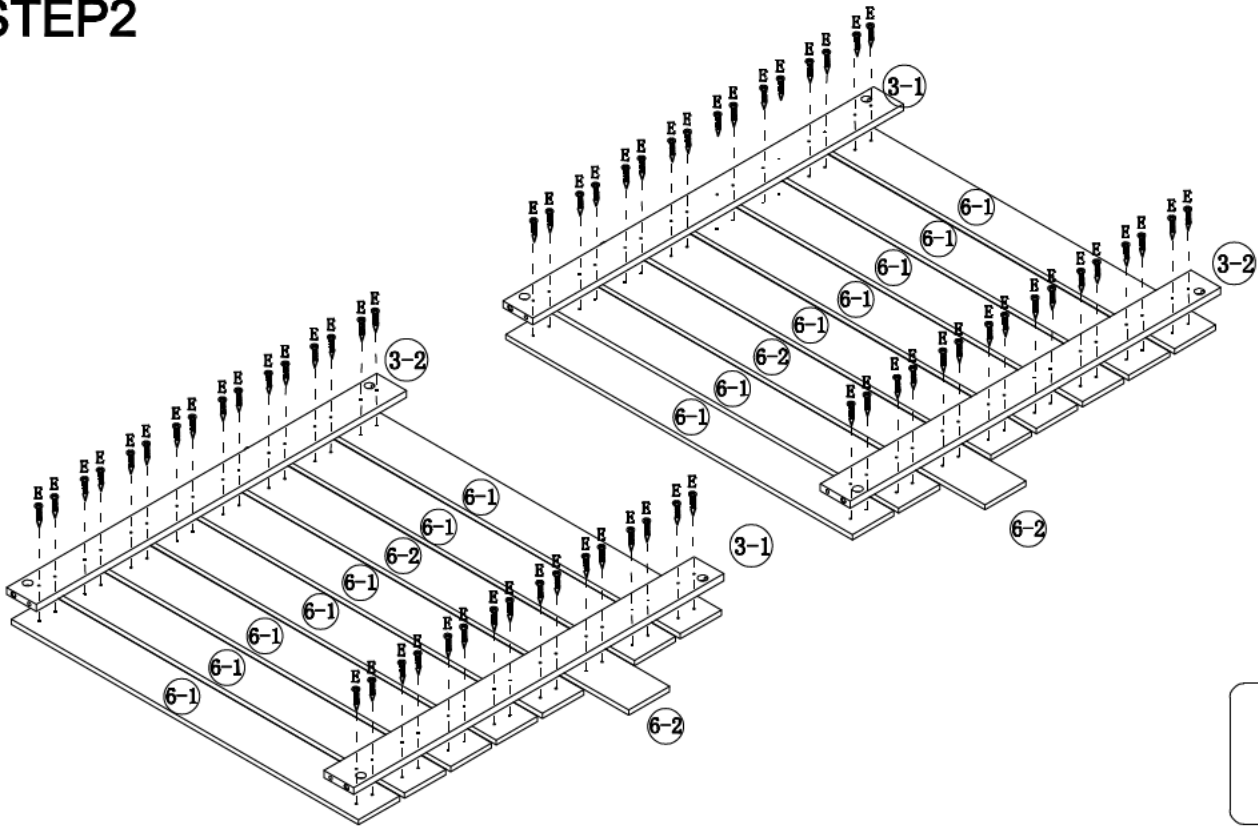

# STEP3

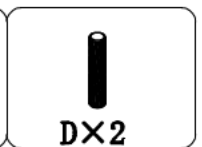
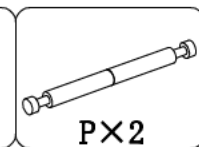
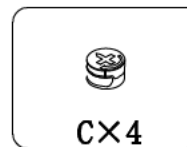
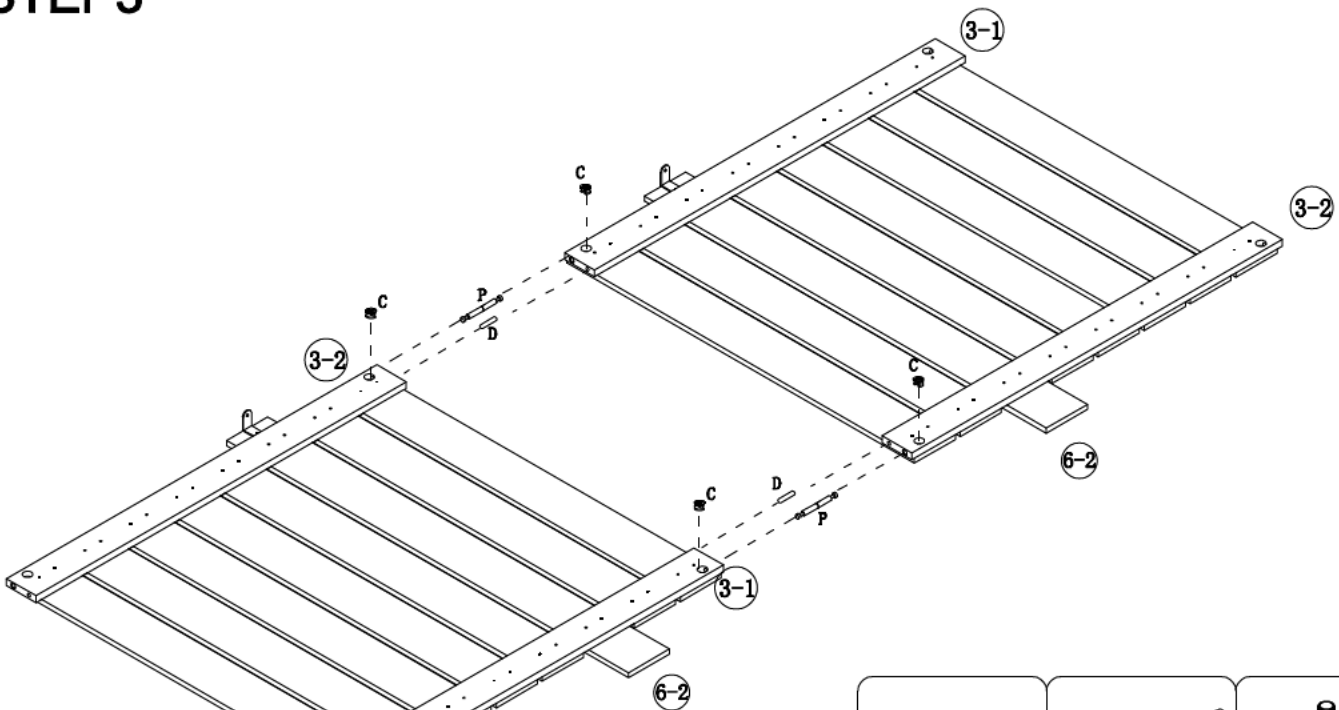

# STEP4

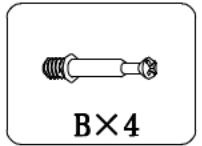
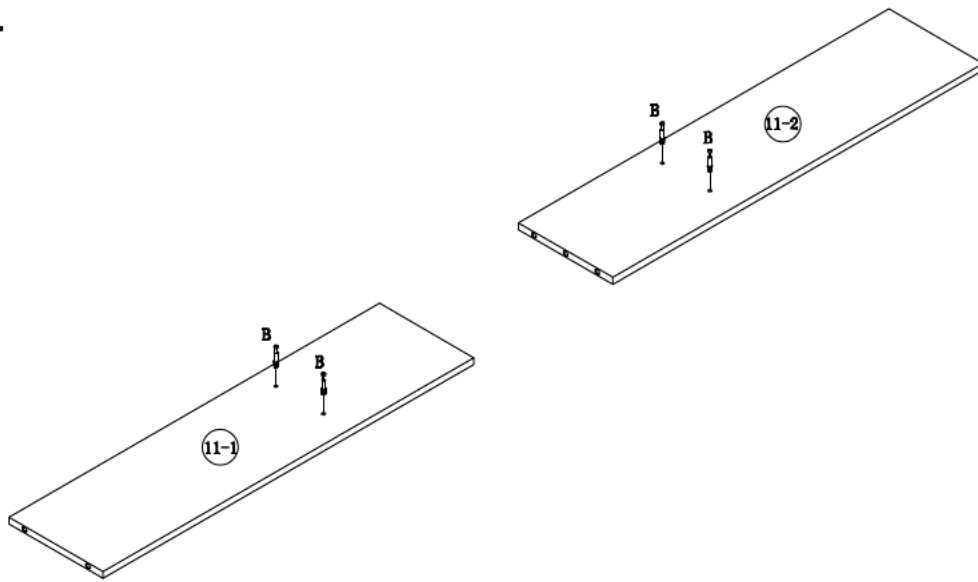

# STEP5

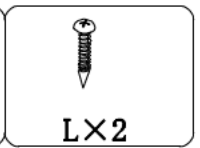
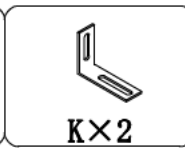
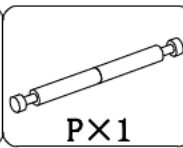
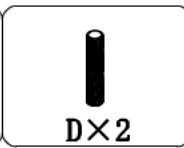
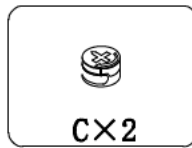
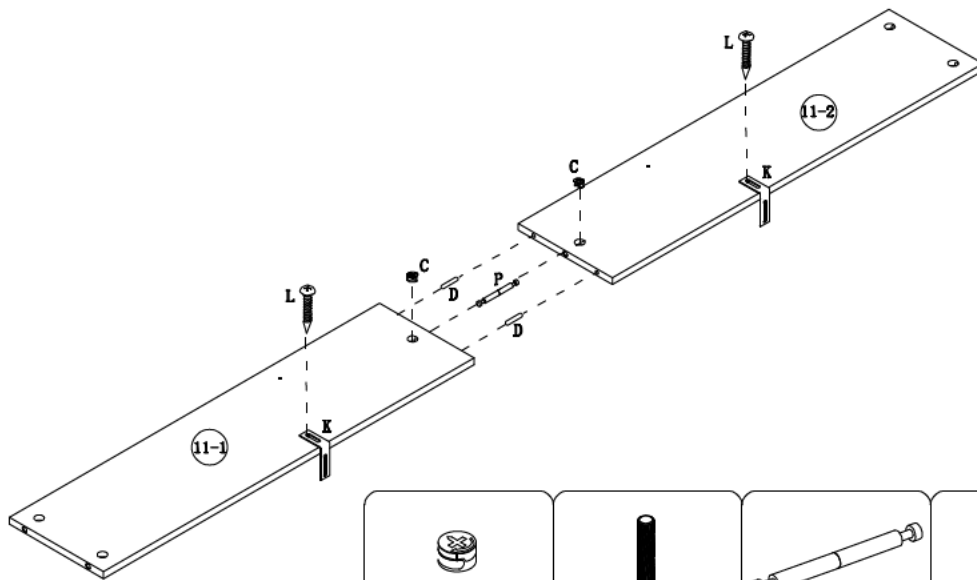

# STEP6

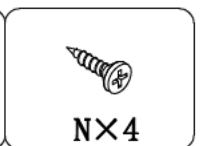
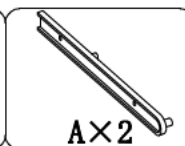
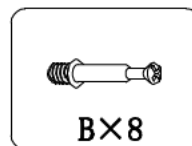
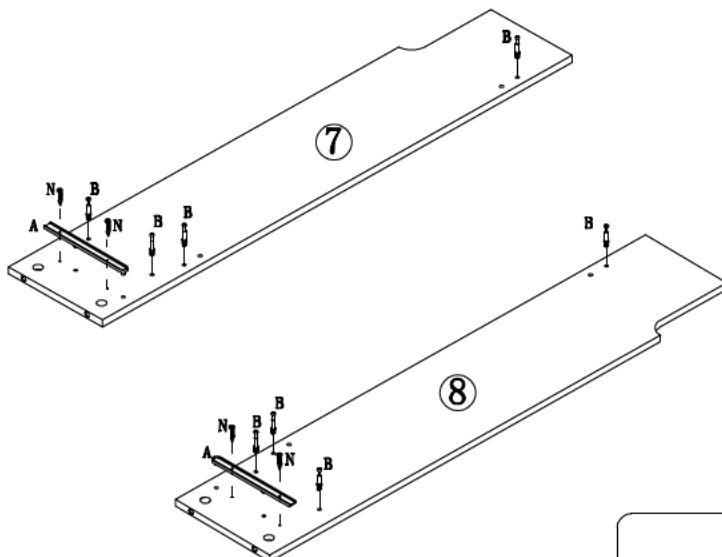



# STEP9

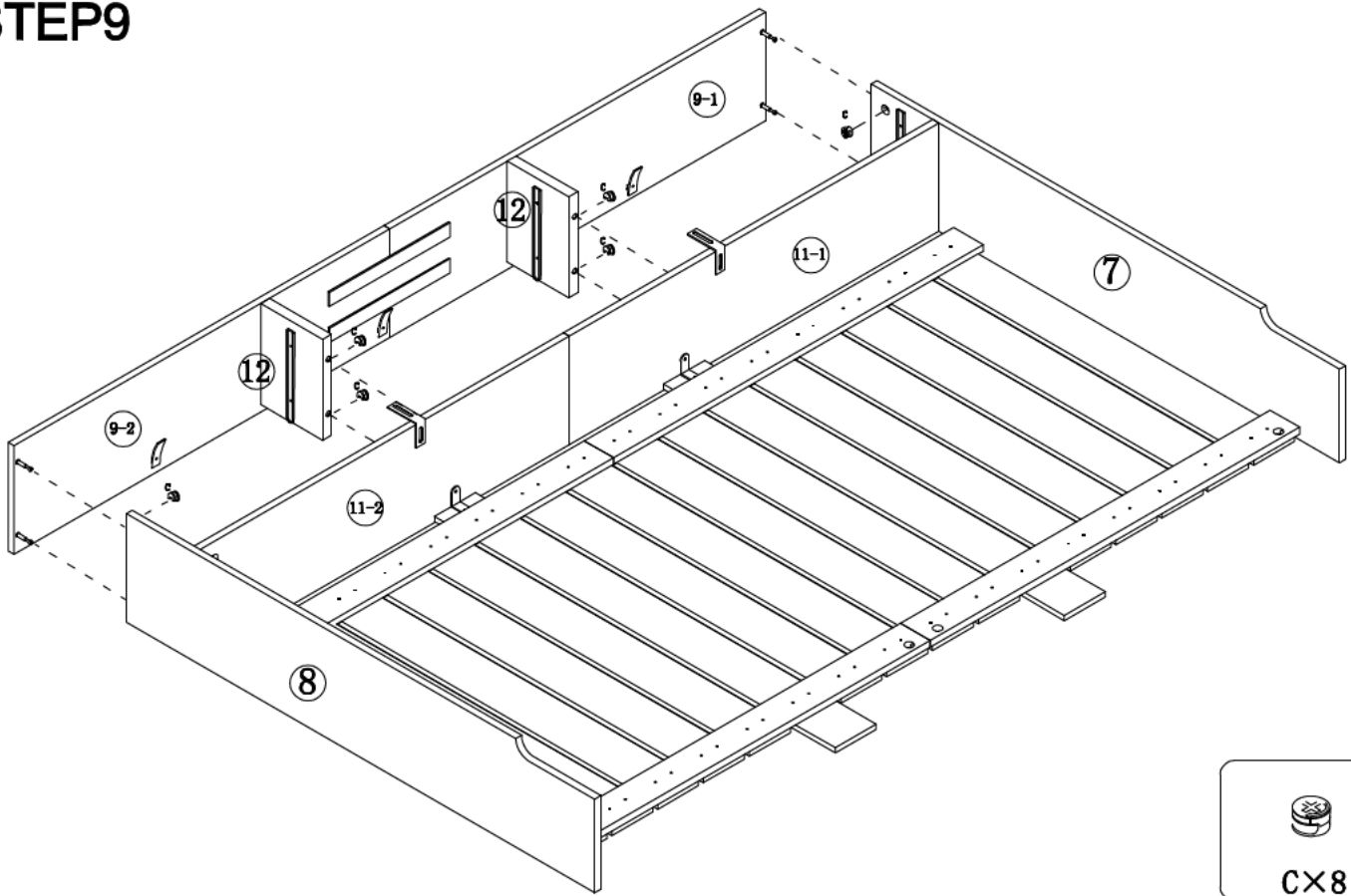

# STEP10

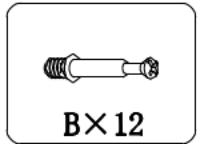
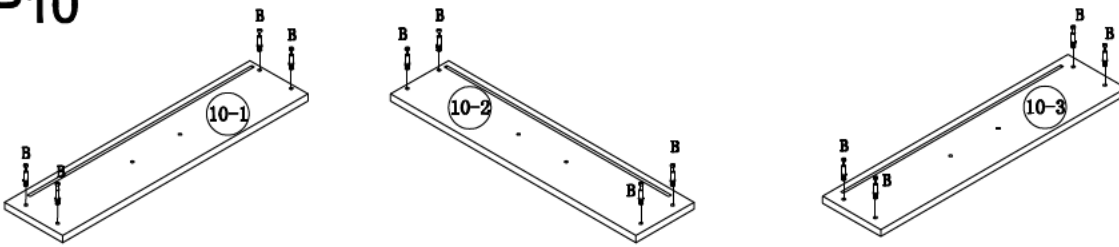



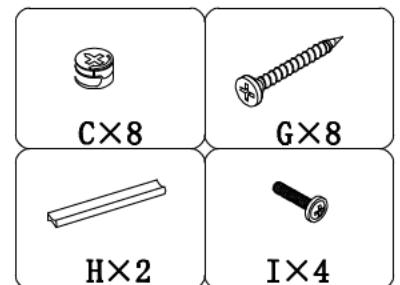
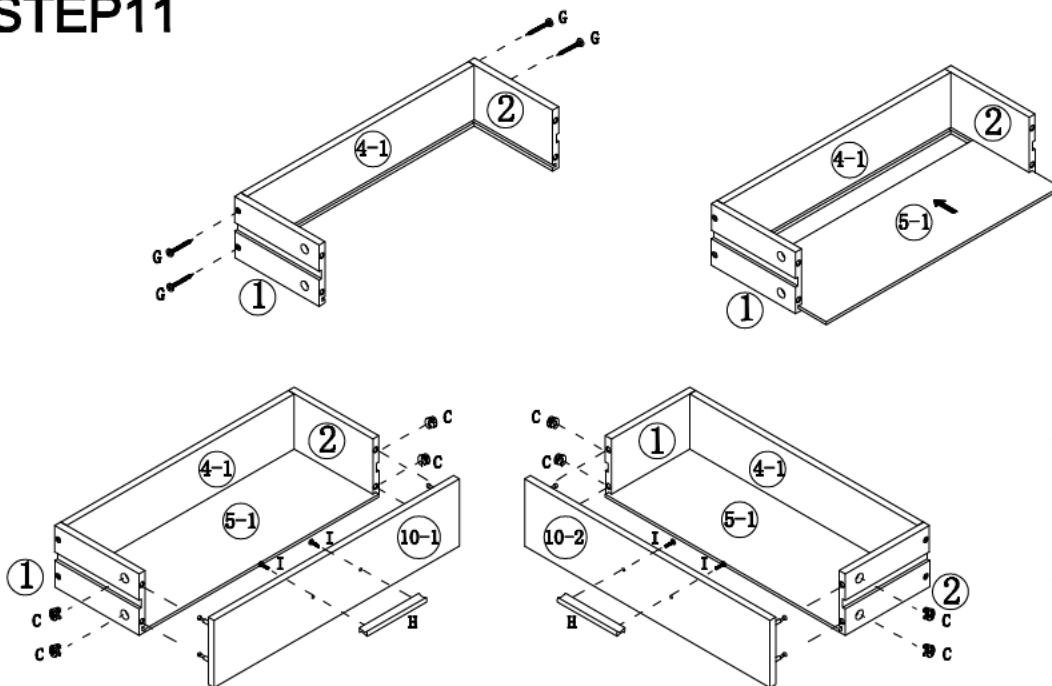

# STEP11

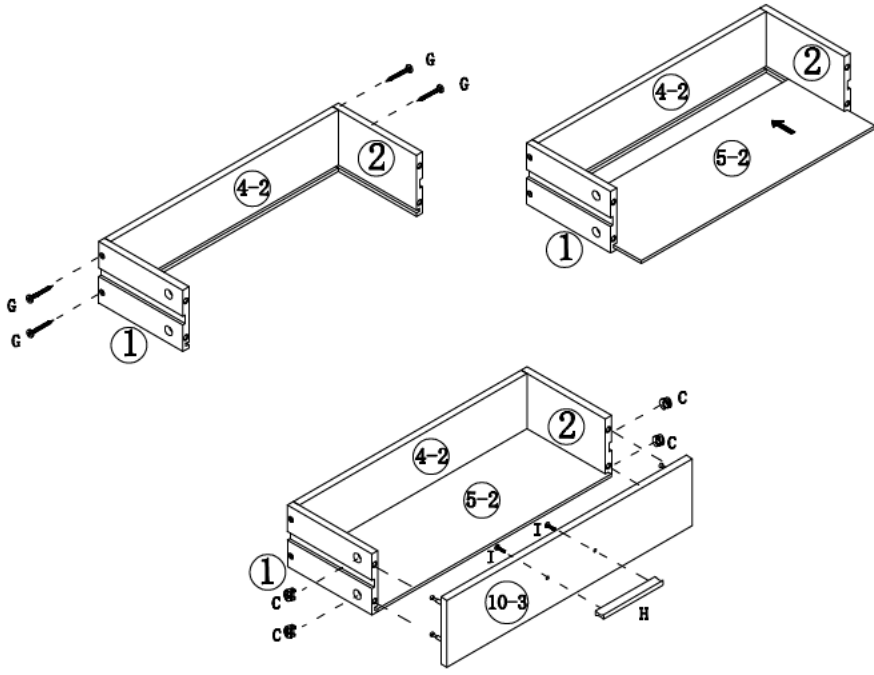



# STEP12

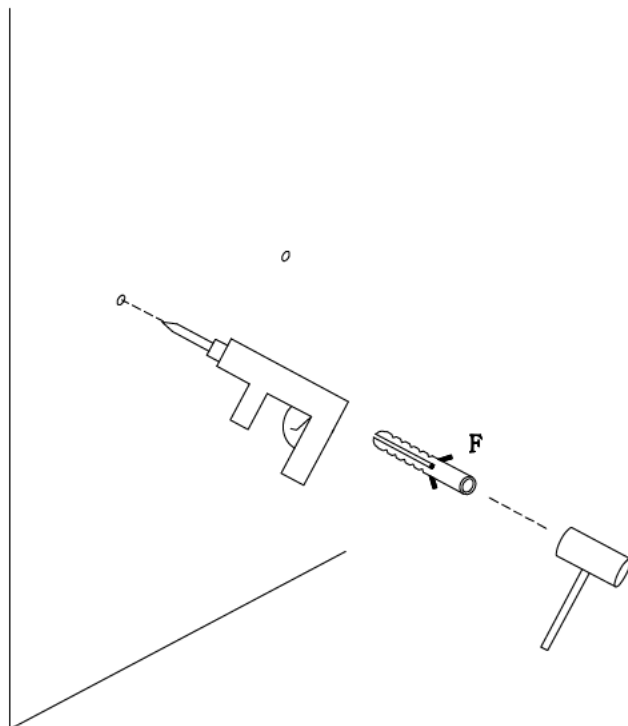

 C×4	 G×4	 H×1	 I×2
--	---	--	--

# STEP13



 F×2
--

## STEP14

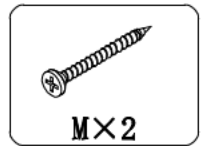
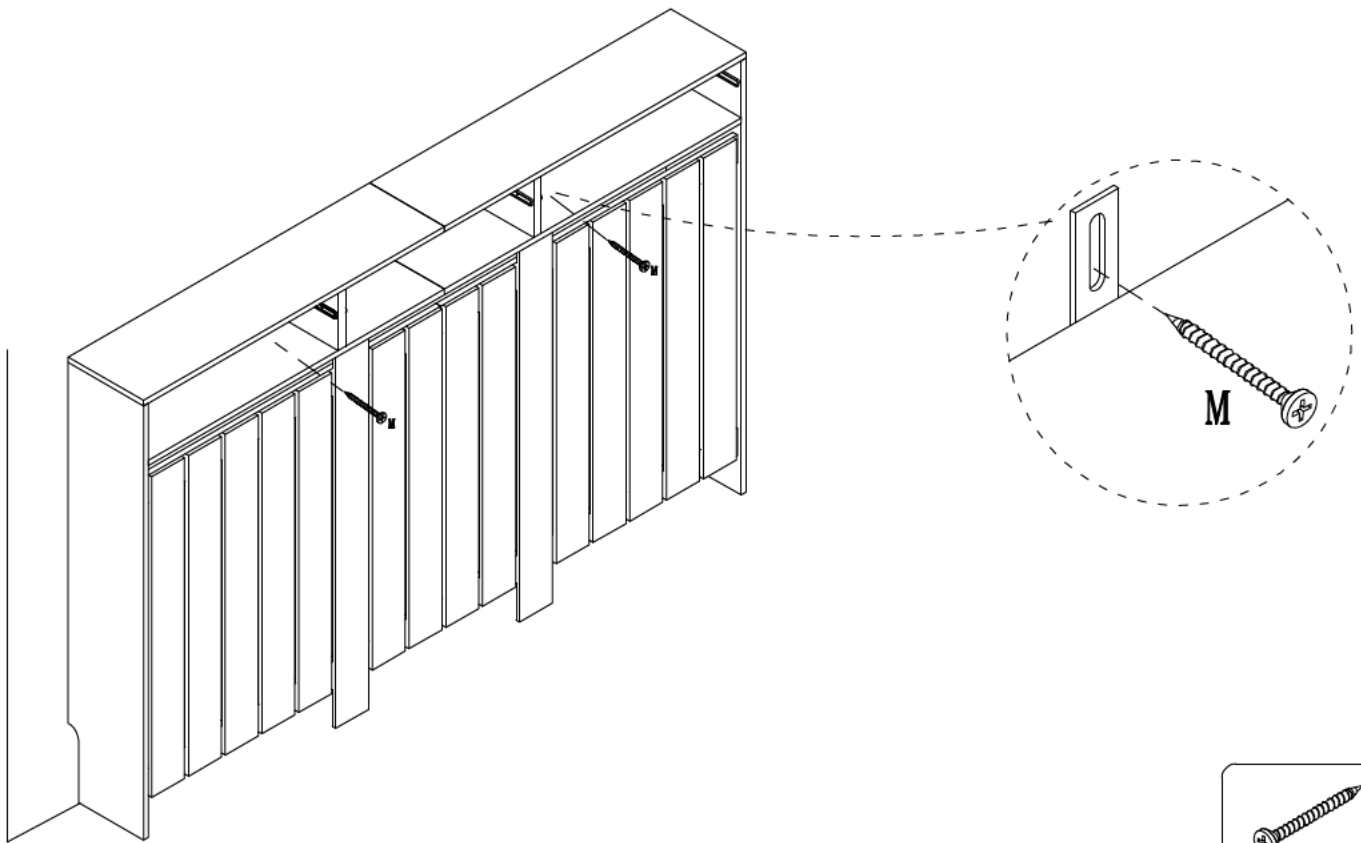

## STEP15

