

ASSEMBLY INSTRUCTION

PACKAGE LIST

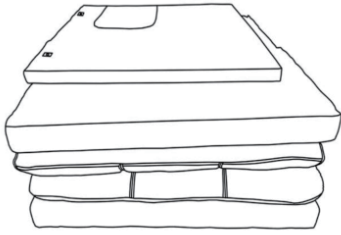

(A)*2
Futon Body

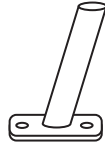

(B)*4
Side Legs

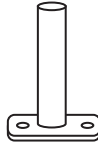

(C)*2
Middle Legs



(D)*8
Bolts
M10*25MM

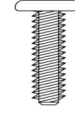

(E)*4
Bolts
M10*40MM

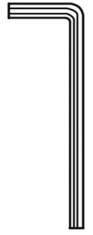

(F)*1
Wrench
6MM

Step 1:

Turn the futon body **(A)** upside down, place the 2 holes with white cardboard on each cushion facing the center of the futon close together. Take out the legs and hardware in the fabric zipper pocket on the underside of the sofa bed.

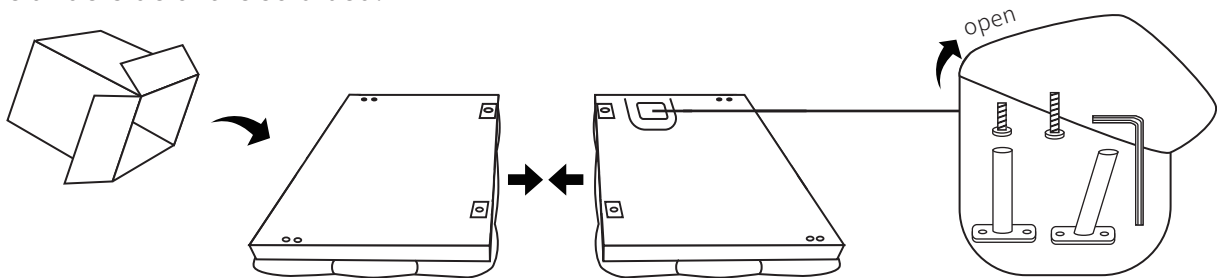

Step 2:

1. Attach the Middle Legs **(C)*2** to the Futon Body **(A)** with Four Bolts **(E)*4**, using the Wrench **(F)**.
2. Attach the Side Legs **(B)*4** to the Futon Body **(A)** with Eight Bolts **(D)*8**, using the Wrench **(F)**.

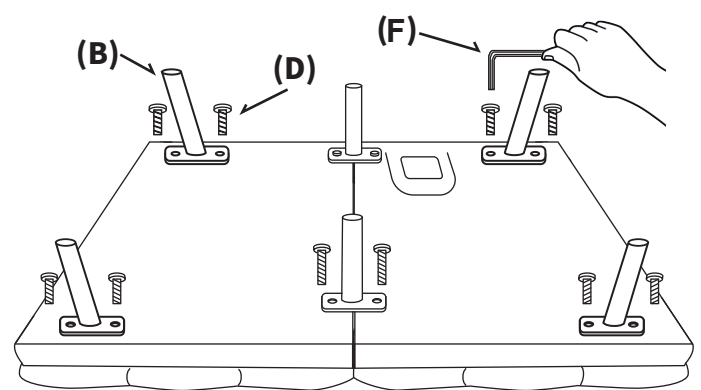
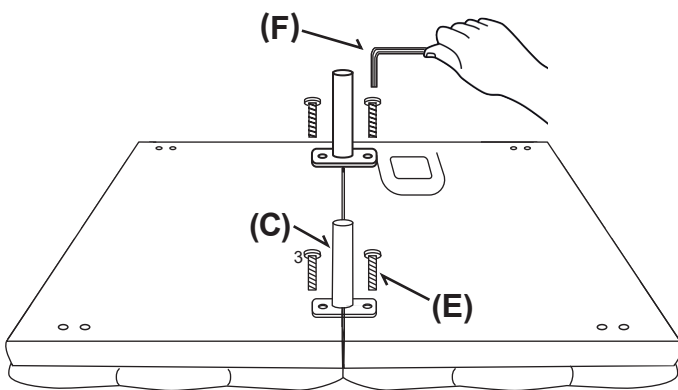

Step 3:

Flip the Futon over so it is supported on its legs, the assembly is complete.

NOTE: Leaving the sofa for 24 hours after unpacking to help the cushions to rebound to its original shape.

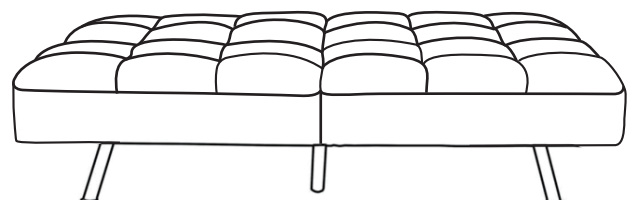

INSTRUCTIONS FOR USE

