







PartsList			
Item	Description	Part	Qty Pcs
1	Top Frame	 900x900x29	1
2	Front apron	 780x60x18	2
3	Left apron	 740x60x18	2

HardwareList			
Item	Description	Part	Qty Pcs
A	Cam lock	 Ø15x12 mm	16
B	Cam lock bolt	 M6x29 mm	16
C	Allen Wrench		1



1

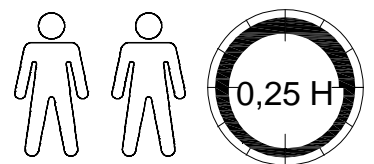
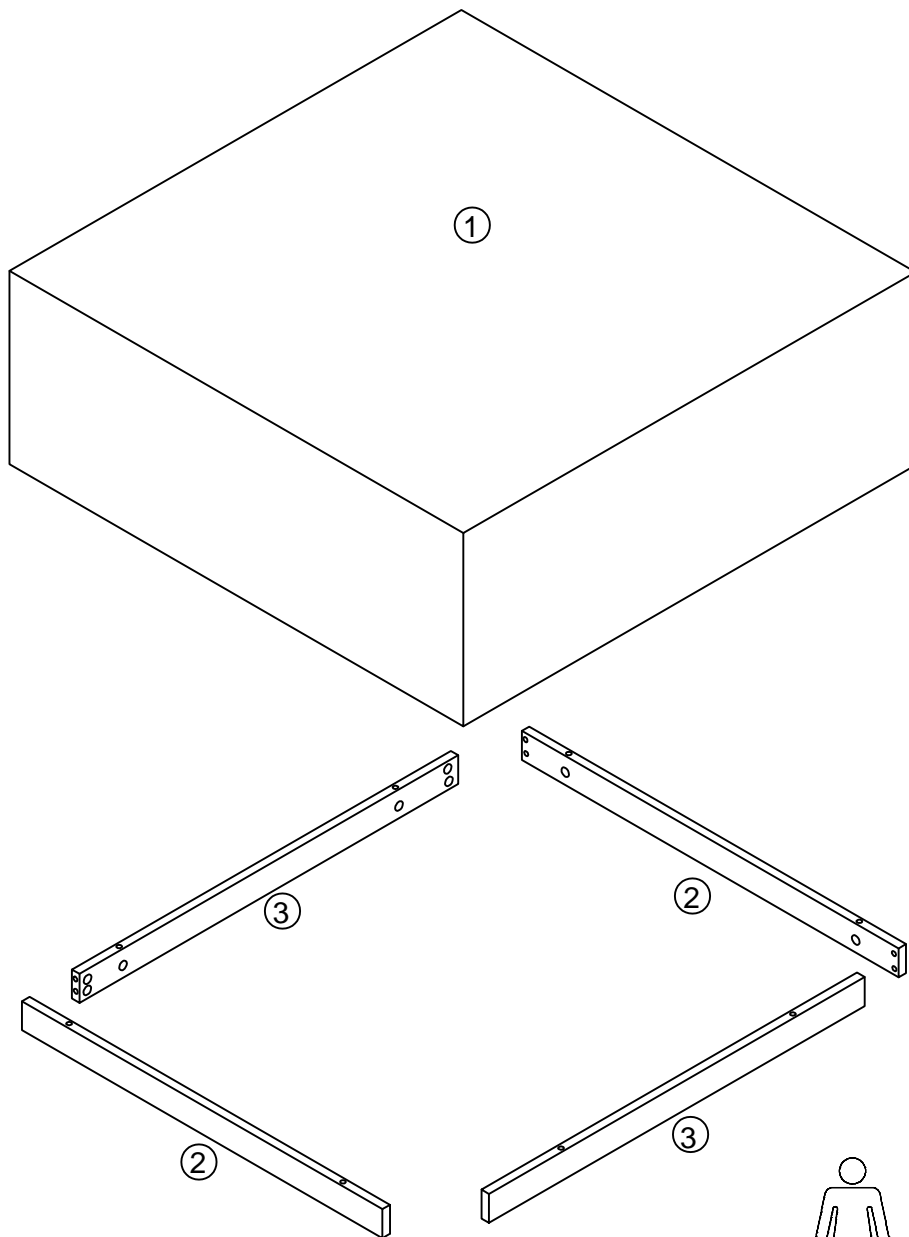
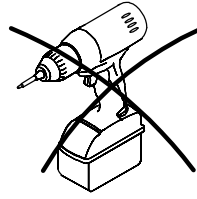
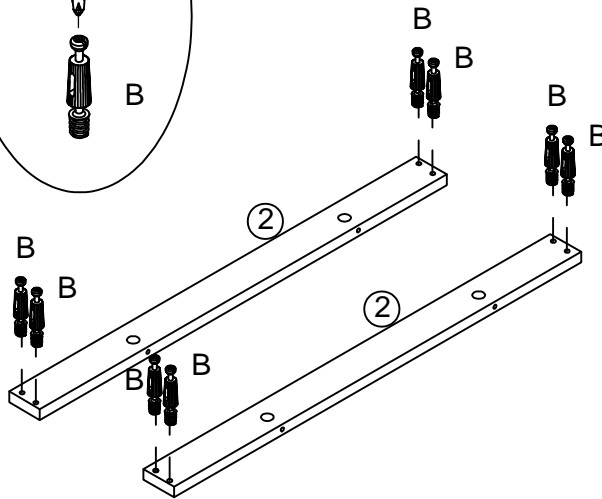
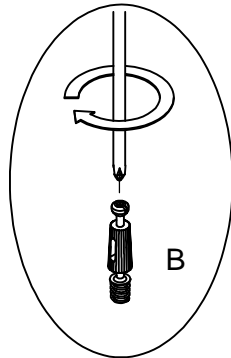
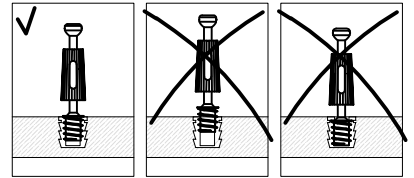
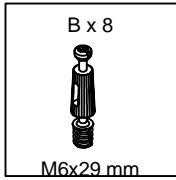

2

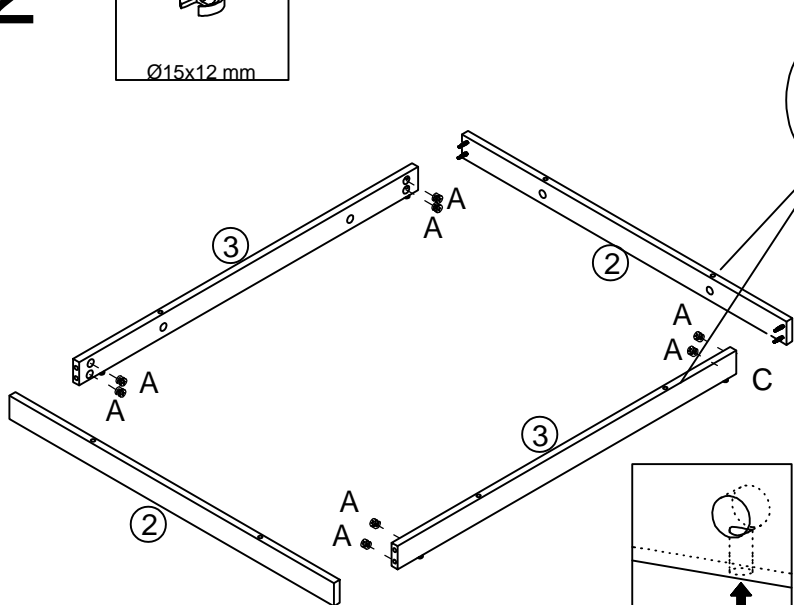
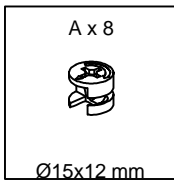

Note: Keep all pre-drilled holes on the same face and facing the same direction. If any slat is flipped, the frame won't line up when mounting to the coffee table.

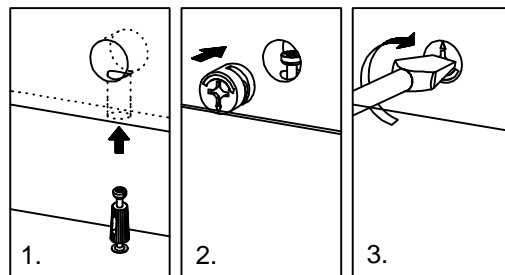

3

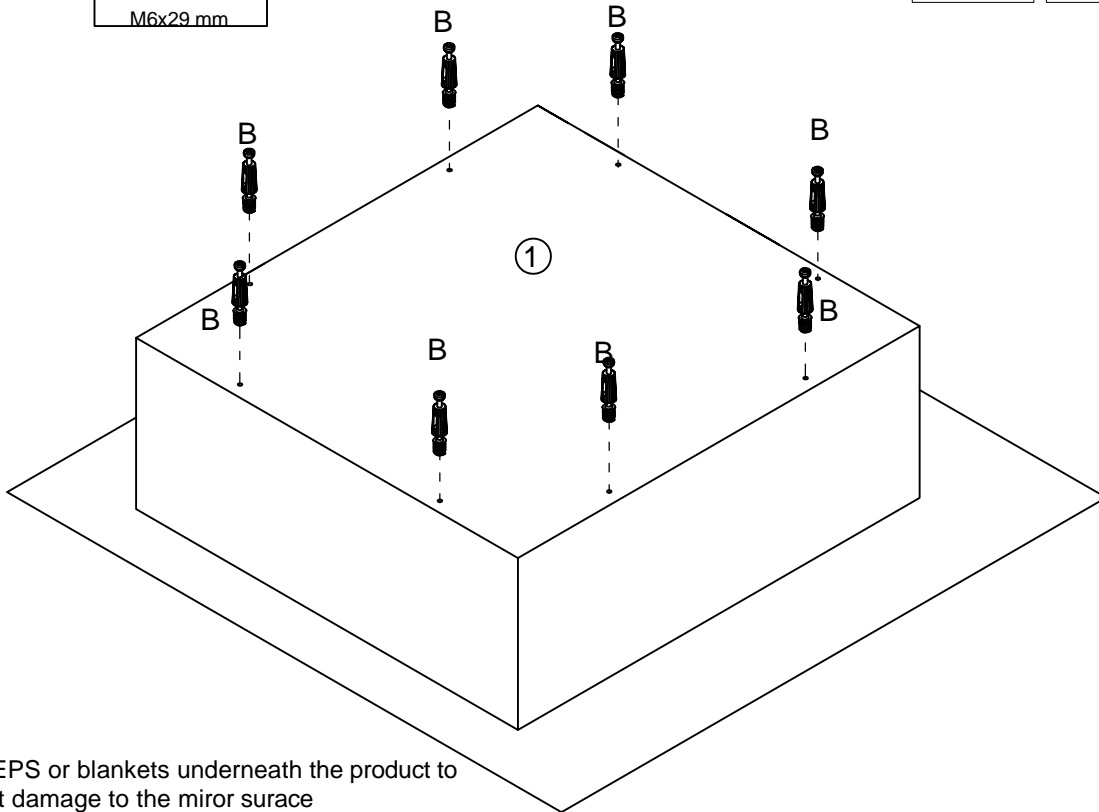
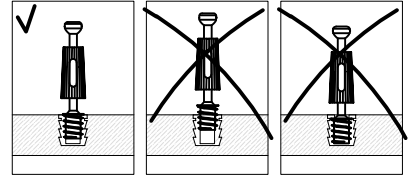
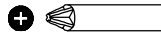
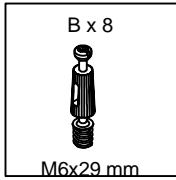

Place EPS or blankets underneath the product to prevent damage to the mirror surface
Two people work together to lift the top and slowly flip it over

4

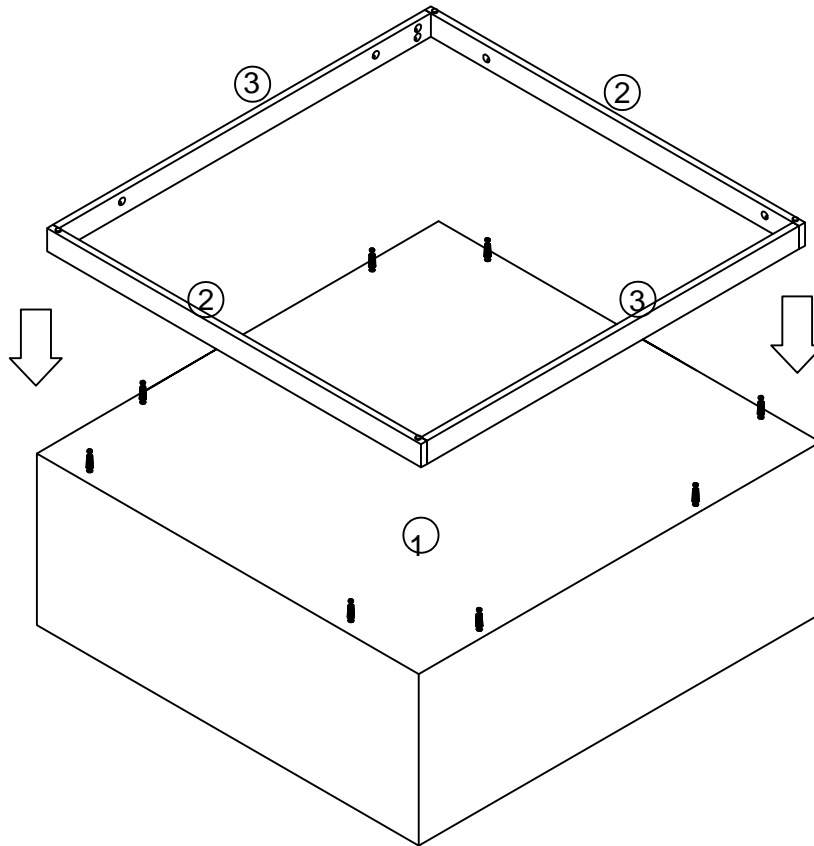

5

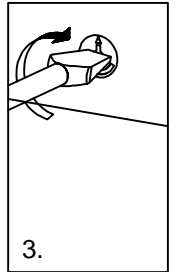
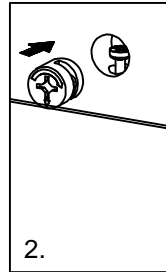
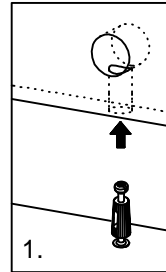
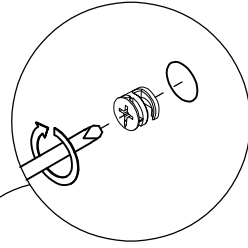
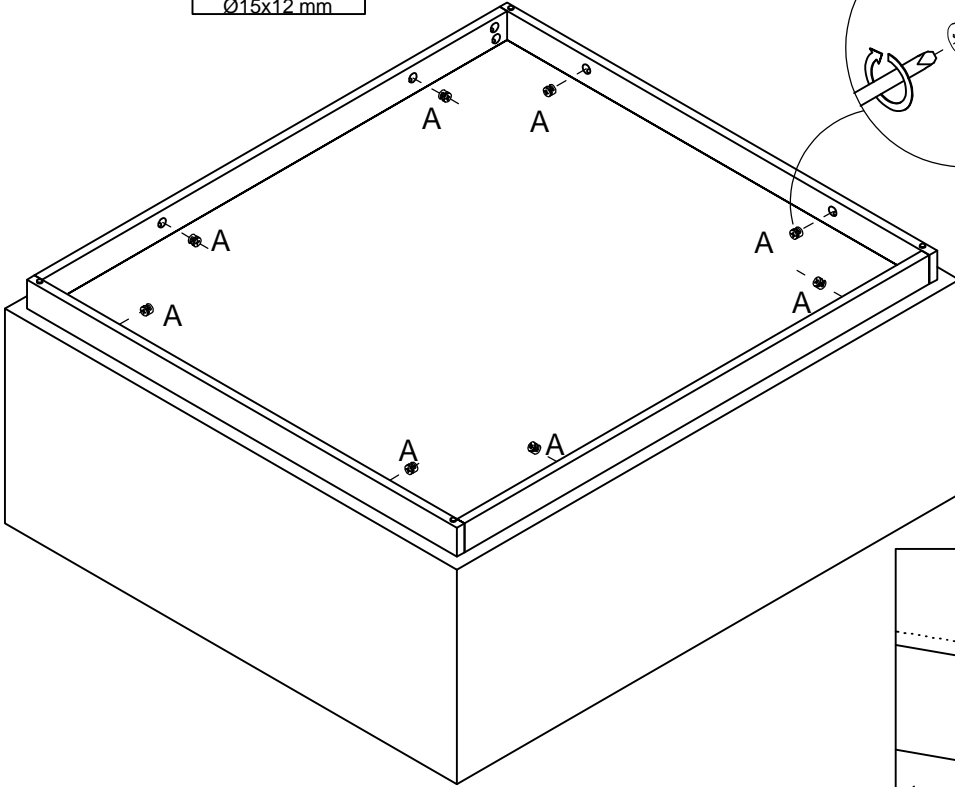
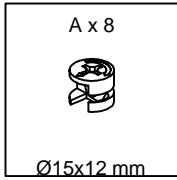

6

