

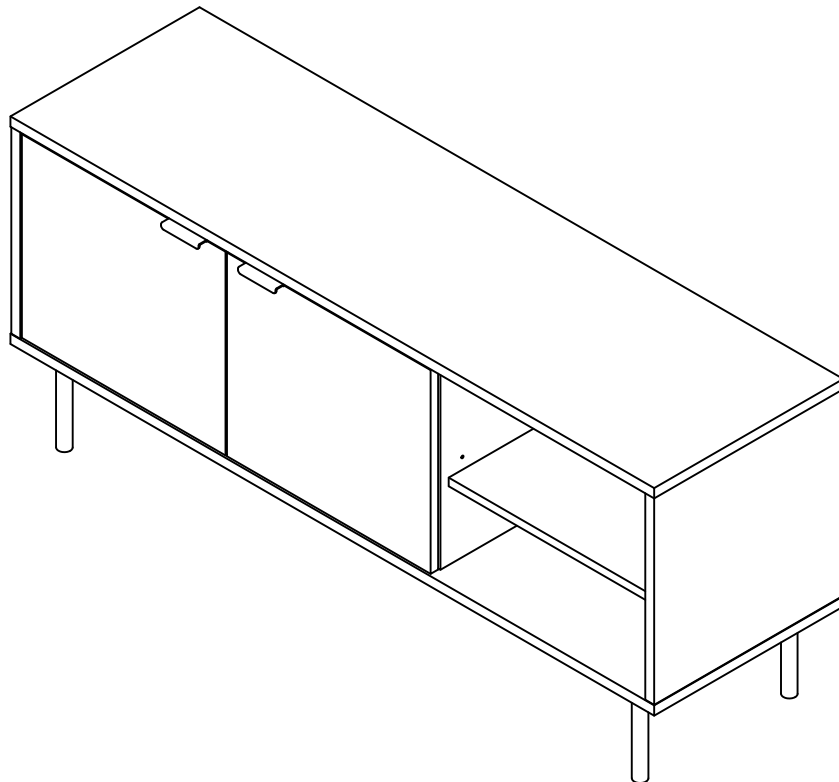

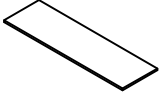

CROSLEY
FURNITURE

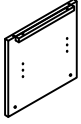

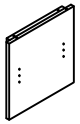
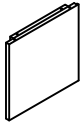
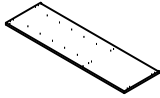
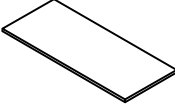
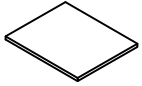

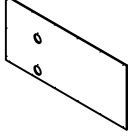
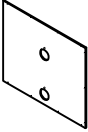
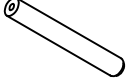
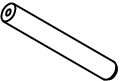





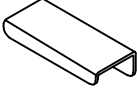
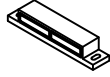

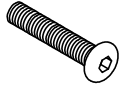



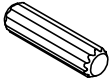

Record Storage Sideboard
CF1144

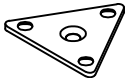

PARTS LIST

<p>A</p> 	<p>B</p> 	<p>C</p> 	<p>D</p> 	<p>E</p> 
<p>Top Panel 1 PC</p>	<p>Left Panel 1 PC</p>	<p>Partition Panel 1 PC</p>	<p>Right Panel 1 PC</p>	<p>Bottom Panel 1 PC</p>
<p>F</p> 	<p>G</p> 	<p>H</p> 	<p>I</p> 	<p>J</p> 
<p>Left Adjustable Shelf 1 PC</p>	<p>Right Adjustable Shelf 1 PC</p>	<p>Left Door 1 PC</p>	<p>Right Door 1 PC</p>	<p>Left Back Panel 1 PC</p>
<p>K</p> 	<p>L</p> 	<p>M</p> 	<p>N</p> 	<p>O</p> 
<p>Right Back Panel 1 PC</p>	<p>Leg 4 PCS</p>	<p>Support Leg 2 PCS</p>	<p>Cover 4 PCS</p>	<p>Metal Wire 5 PCS</p>

HARDWARE LIST

#1 	#2 	#3 	#4  1/4"*51mm	#5  1/4"*25mm
Handle 2 PCS	Double Magnet 1 PC	Shelf Holder 8 PCS (Extra 1)	Long Bolt 6 PCS (Extra 1)	Round Head Bolt 6 PCS (Extra 1)
#6  1/4"*25mm	#7  1/4"*16mm	#8  1/4"*10mm	#9  1/4"*13mm	#10  8*30mm
Medium Bolt 6 PCS (Extra 1)	Short Bolt 18 PCS (Extra 1)	Spring Washer 12 PCS (Extra 1)	Flat Washer 12 PCS (Extra 1)	Wood Dowel 12 PCS (Extra 1)
#11 	#12  M4	#13  6*3*15mm	#14  6*3*15mm	#15  8*3*12mm
Barrel Nut 6 PCS (Extra 1)	Hex Nut 10 PCS (Extra 1)	Long Screw 4 PCS (Extra 1)	Round Head Screw 2 PCS (Extra 1)	Short Screw 29 PCS (Extra 1)
#16 	#17 	#18  M4	#19  M2	#20 
Binding Post 4 SET (Extra 1)	Connecting Bar 6 PCS	Allen Wrench 1 PC	Small Allen Wrench 1 PC	Wrench 1 PC

ADDITIONAL TOOLS (Not Provided)

Note: It is not recommended to use power tools during assembly.

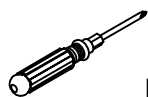



Phillips Head Screwdriver

Note: Wood dowels are intended for alignment. Additional clearance between wood dowel and pre-drilled hole is intentional for ease of assembly.

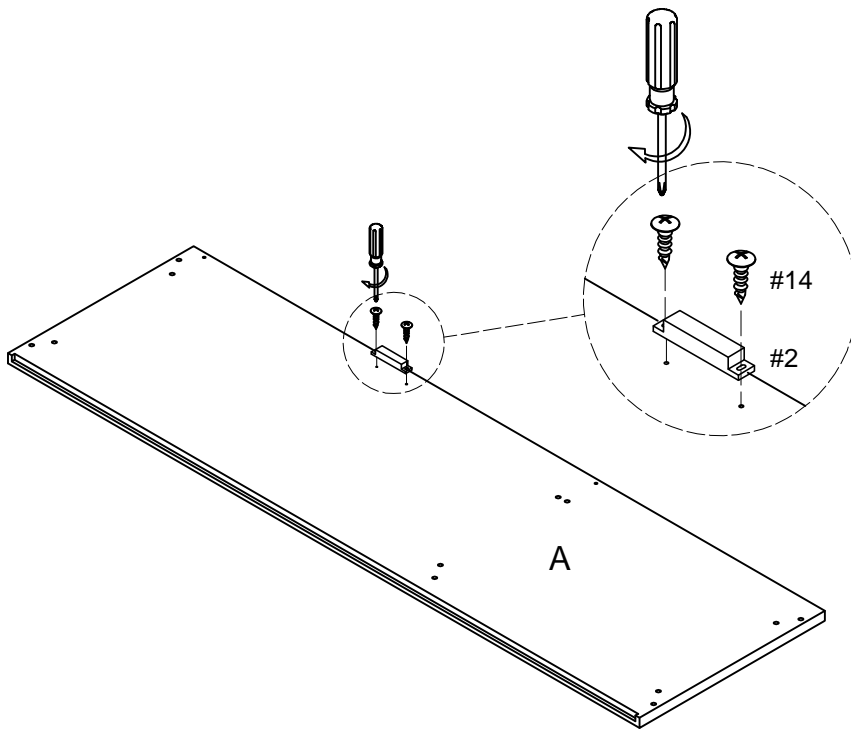

Step 1. Attach double magnet (part #2) to top panel (part A) using round head screws (part #14) and phillips head screwdriver.





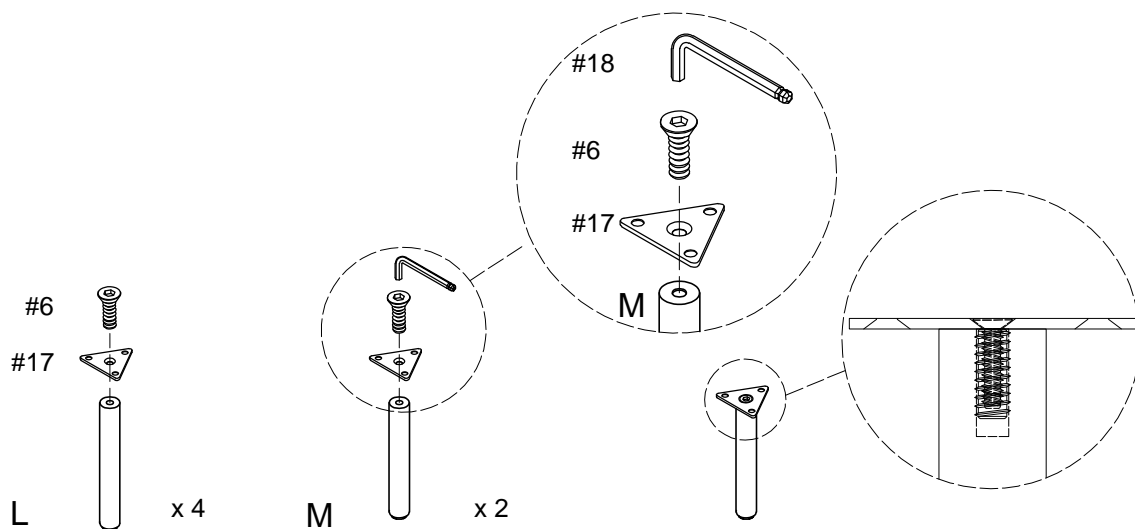

- | | | |
|-----|---|-----|
| #2 |  | x 1 |
| #14 |  | x 2 |

Step 2. Attach connecting bars (part #17) to legs and support legs (parts L & M) using medium bolts (part #6) and allen wrench (part #18).



- | | | |
|-----|---|-----|
| #6 |  | |
| #17 |  | |
| L |  | x 4 |

- | | | |
|---|---|-----|
| M |  | x 2 |
|---|---|-----|

- | | | |
|-----|---|-----|
| #6 |  | x 6 |
| #17 |  | x 6 |
| #18 |  | x 1 |

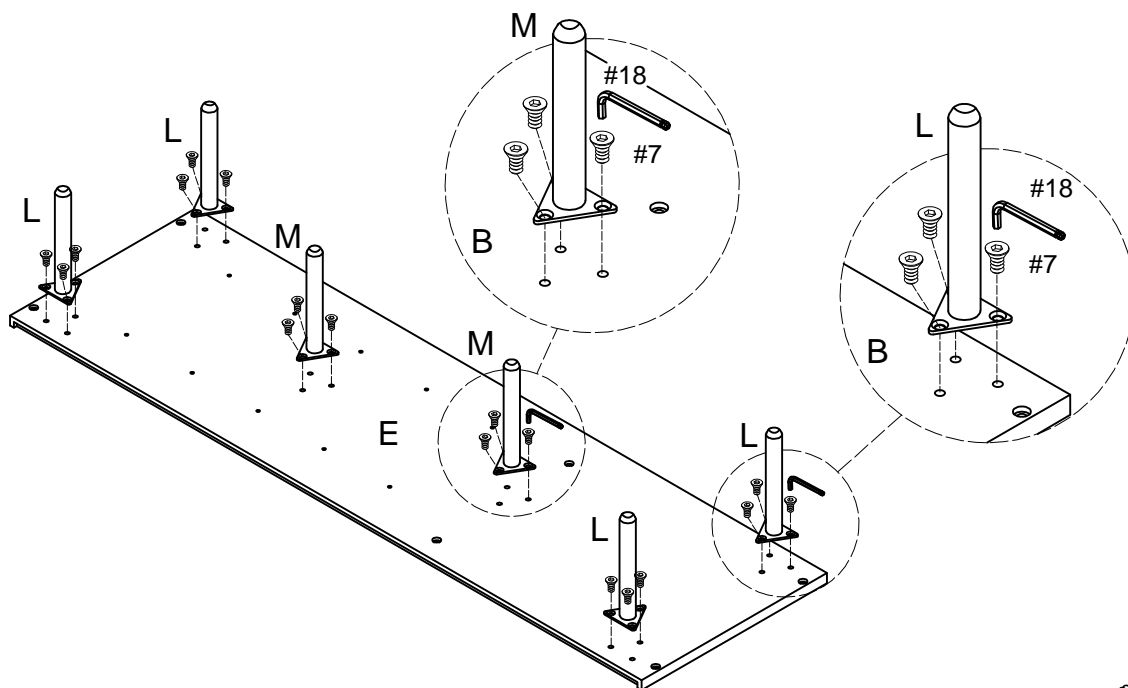

Step 3. Attach legs and support legs (parts L & M) to bottom panel (part E) using short bolts (part #7) and allen wrench (part #18).



- | | | |
|-----|---|------|
| #7 |  | x 18 |
| #18 |  | x 1 |

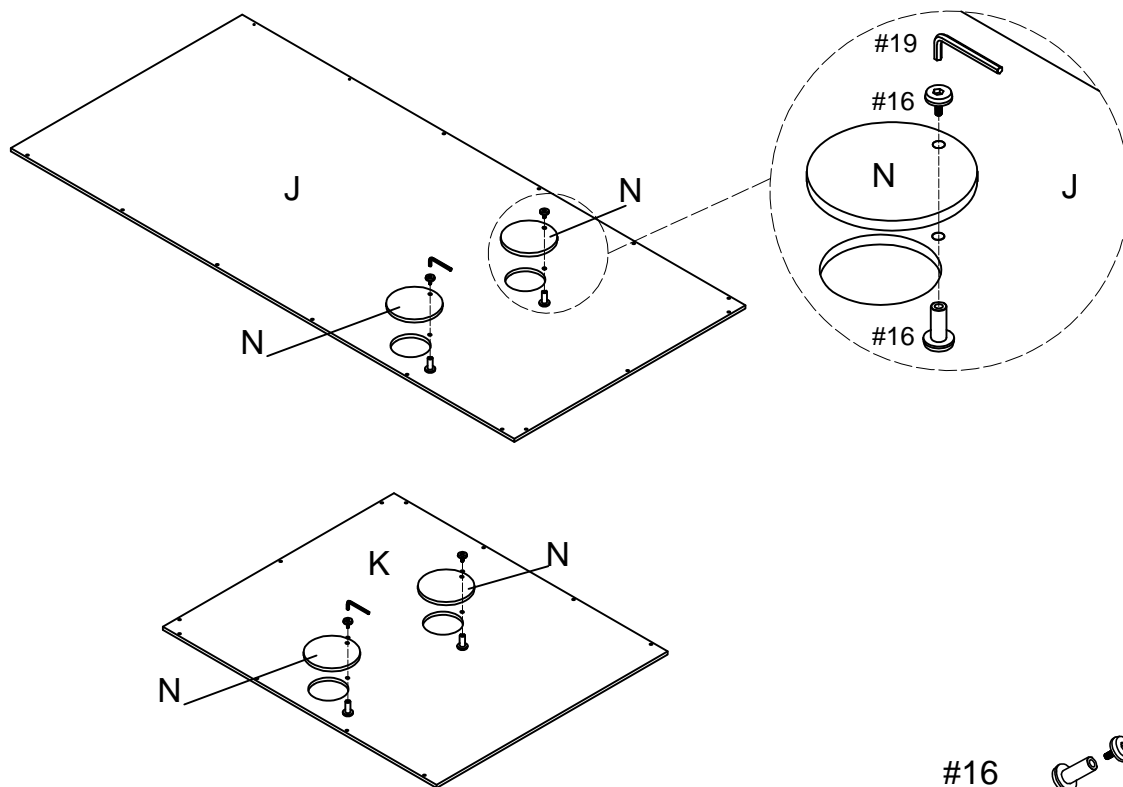

Step 4. Attach covers (part N) to back panels (parts J & K) using binding posts (part #16) and small allen wrench (part #19).

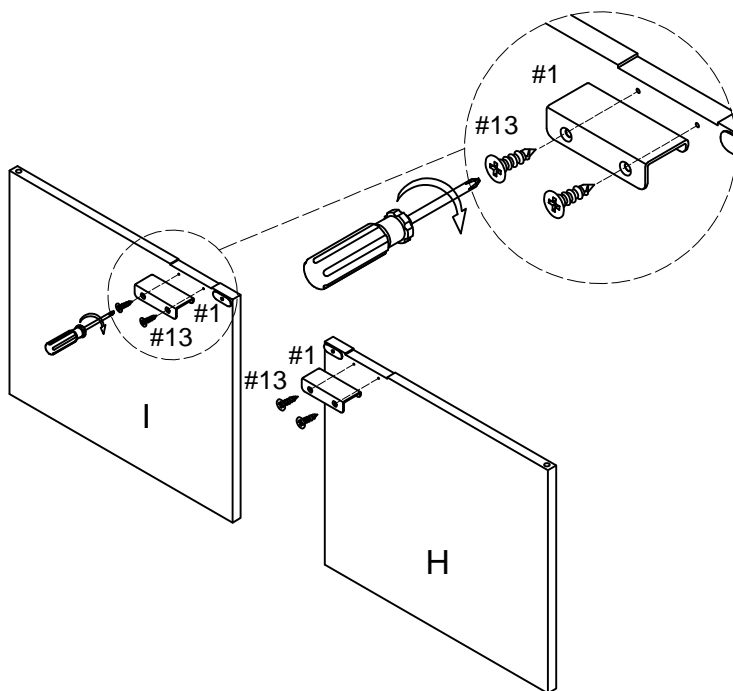

- | | | |
|-----|---|-----|
| #16 |  | x 4 |
| #19 |  | x 1 |

Step 5. Attach handles (part #1) to doors (parts H & I) using long screws (part #13) and phillips head screwdriver.



#1		x 2
#13		x 4

Step 6. Attach panels (parts B, C & D) to top panel (part A) using wood dowels (part #11), round head bolts (part #5), spring washers (part #8), flat washers (part #9) and allen wrench (part #18).

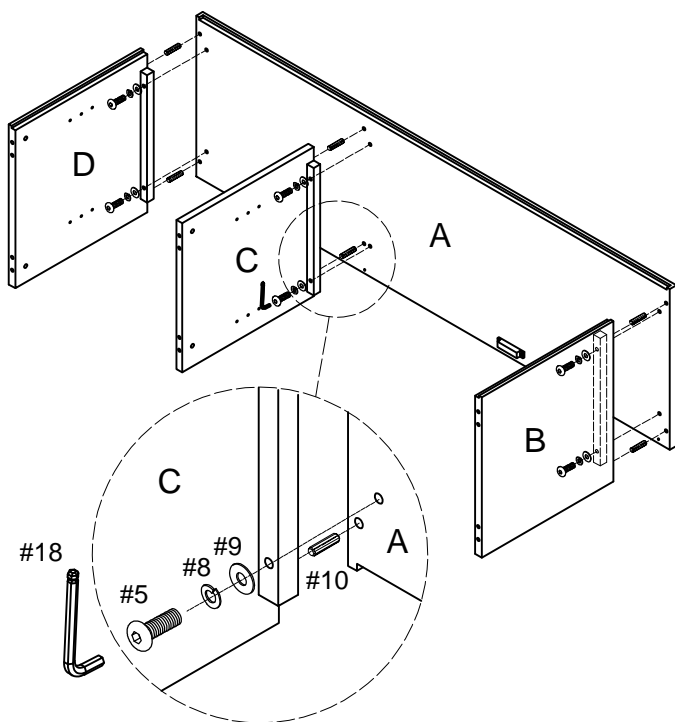

#5		x 6
#8		x 6
#9		x 6
#10		x 6
#18		x 1

Step 7. Attach bottom panel (part E) to assembled unit (parts B, C & D) using wood dowels (part #10), barrel nuts (part #11), long bolts (part #4), spring washers (part #8), flat washers (part #9) and allen wrench (part #18).

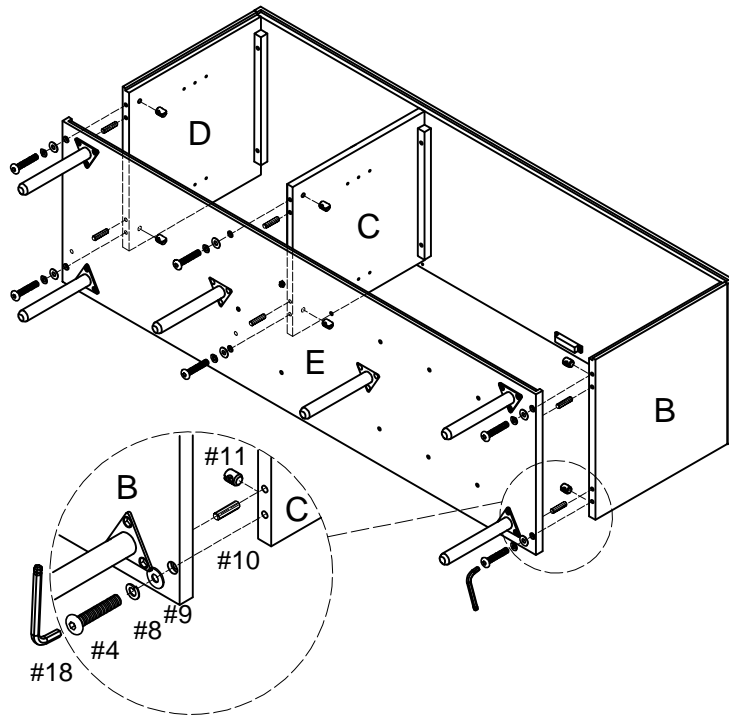

- | | | |
|-----|---|-----|
| #4 |  | x 6 |
| #8 |  | x 6 |
| #9 |  | x 6 |
| #10 |  | x 6 |
| #11 |  | x 6 |
| #18 |  | x 1 |

Step 8. Attach back panels (parts J & K) to assembled unit (parts A, B, C, D & E) using short screws (part #16) and phillips head screwdriver.

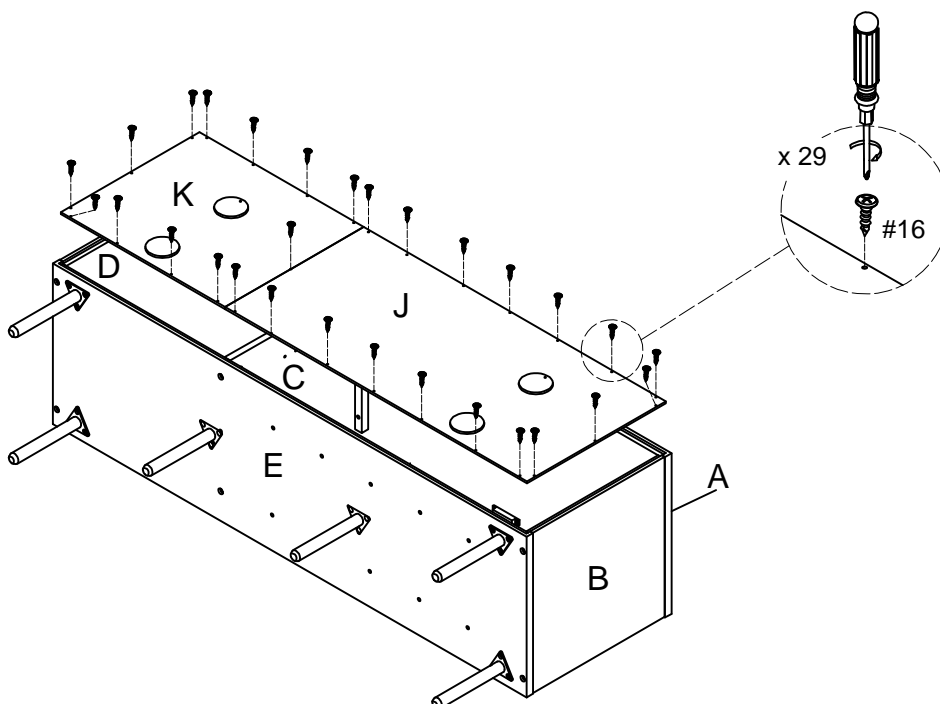

- | | | |
|-----|---|------|
| #16 |  | x 29 |
|-----|---|------|

Step 9. There are two installation option for door storage. Installation wire metal or adjustable shelf.

Insert shelf holders (part #3) and slide left adjustable shelf (part F) into place.

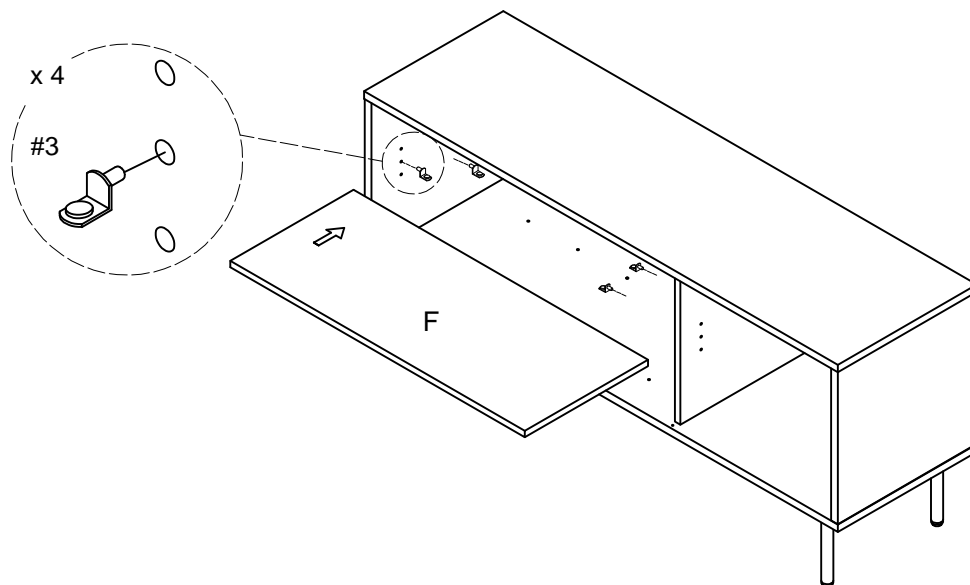

#3  x 4

OR

Carefully put the unit down. Attach metal wires (part O) to bottom panel (part E) using hex nut (part #12) and wrench (part #20).

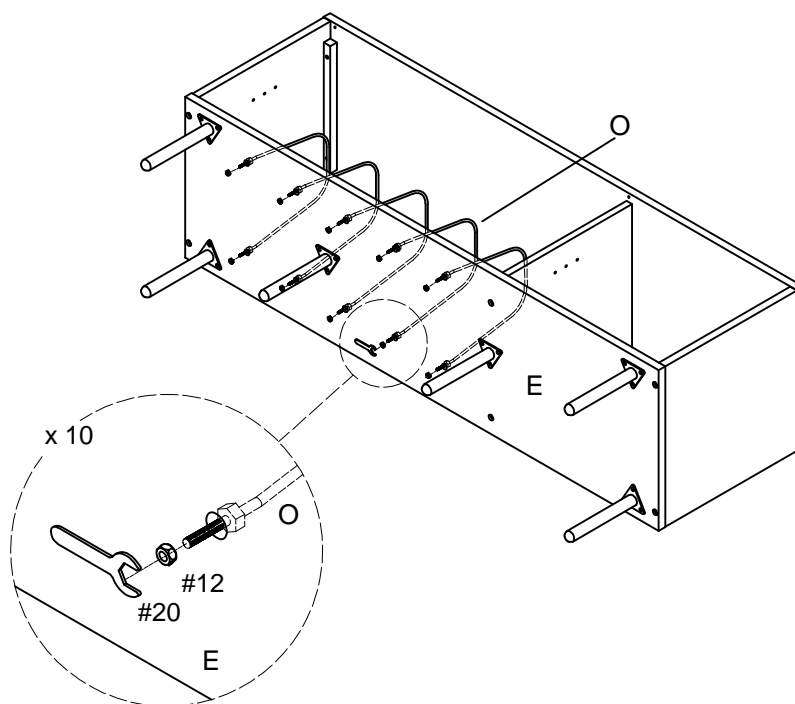

#12  x 10

#20  x 1

Step 10. Attach doors (parts H & I) by placing pin hinge (pre-installed in door) in the pre-drilled hole of bottom panel (part E). Then depress the top spring-loaded pin hinge so it can be placed in the pre-drilled hole of top panel (part A).

NOTE: Be sure top and bottom pin hinges are fully extended to secure doors in place.

NOTE: It is important to adjust levelers once fully assembled and upright. Extend adjustable leveler until it's firmly in contact with the floor. If relocating, adjust leveler as needed until it's firmly in contact with the floor in new location.

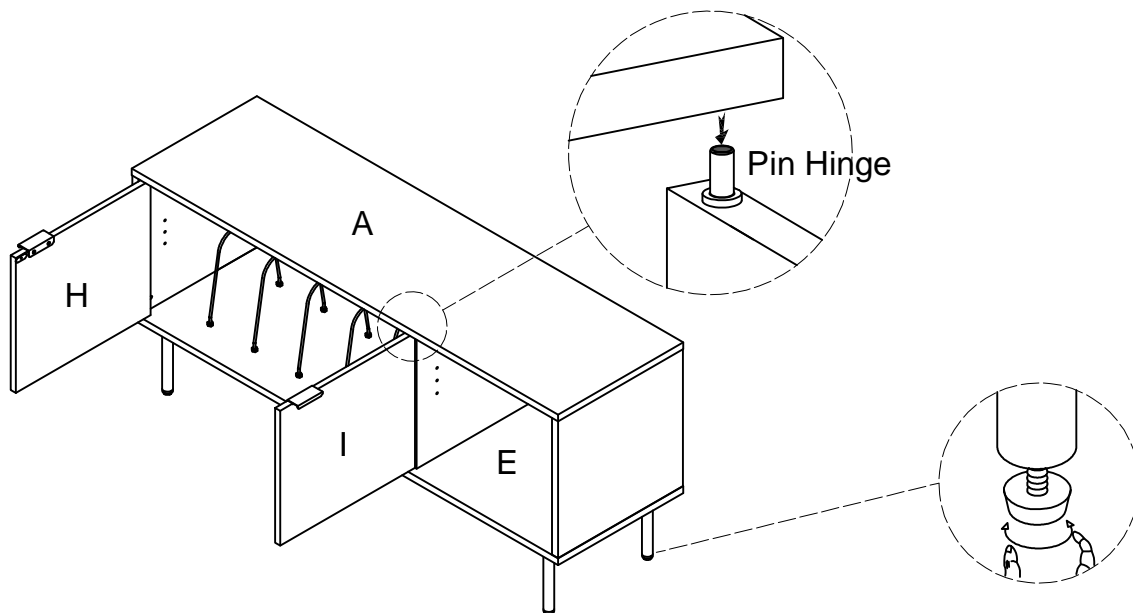

Step 11. Insert shelf holders (part #3) into desired position and slide right adjustable shelf (part G) into place.

