

ASSEMBLY INSTRUCTIONS



Fine Furniture for every stage of life

Bench

ASSEMBLY INSTRUCTIONS

ASSEMBLY TIPS:

1. Remove hardware from box and sort by size.
2. Please check to see that all hardware and parts are present prior to start of assembly.
3. Please follow attached instructions in the same sequence as numbered to assure fast & easy assembly.

WARNING!



1. Don't attempt to repair or modify parts that are broken or defective. Please contact the store immediately.
2. This product is for home use only and not intended for commercial establishments.



ASSEMBLY TIME

5 MINUTES

PARTS IDENTIFICATION

A SEAT CUSHION
WITH FRAME

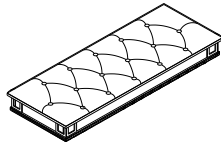

1PC

B BOTTOM
FRAME



1PC

C LEG

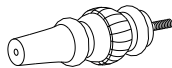

4PCS

D FOOT

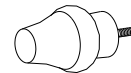

4PCS

STEP 1

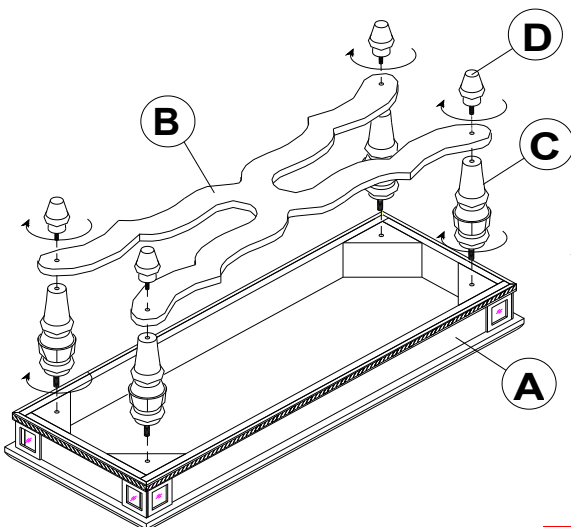

STEP 2 COMPLETE

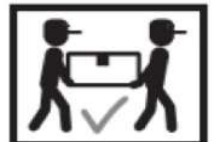
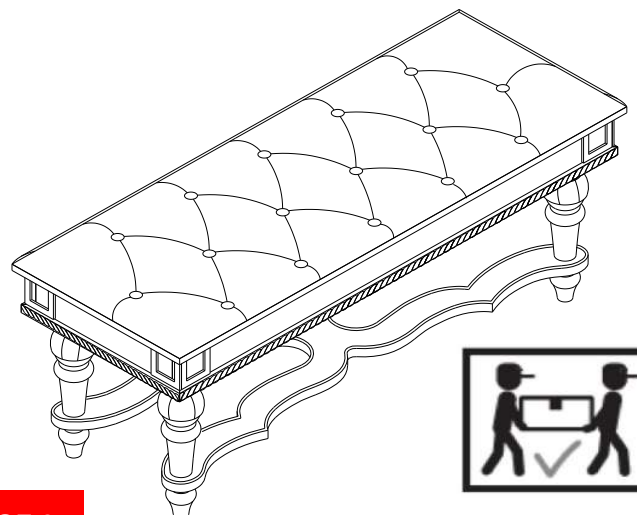

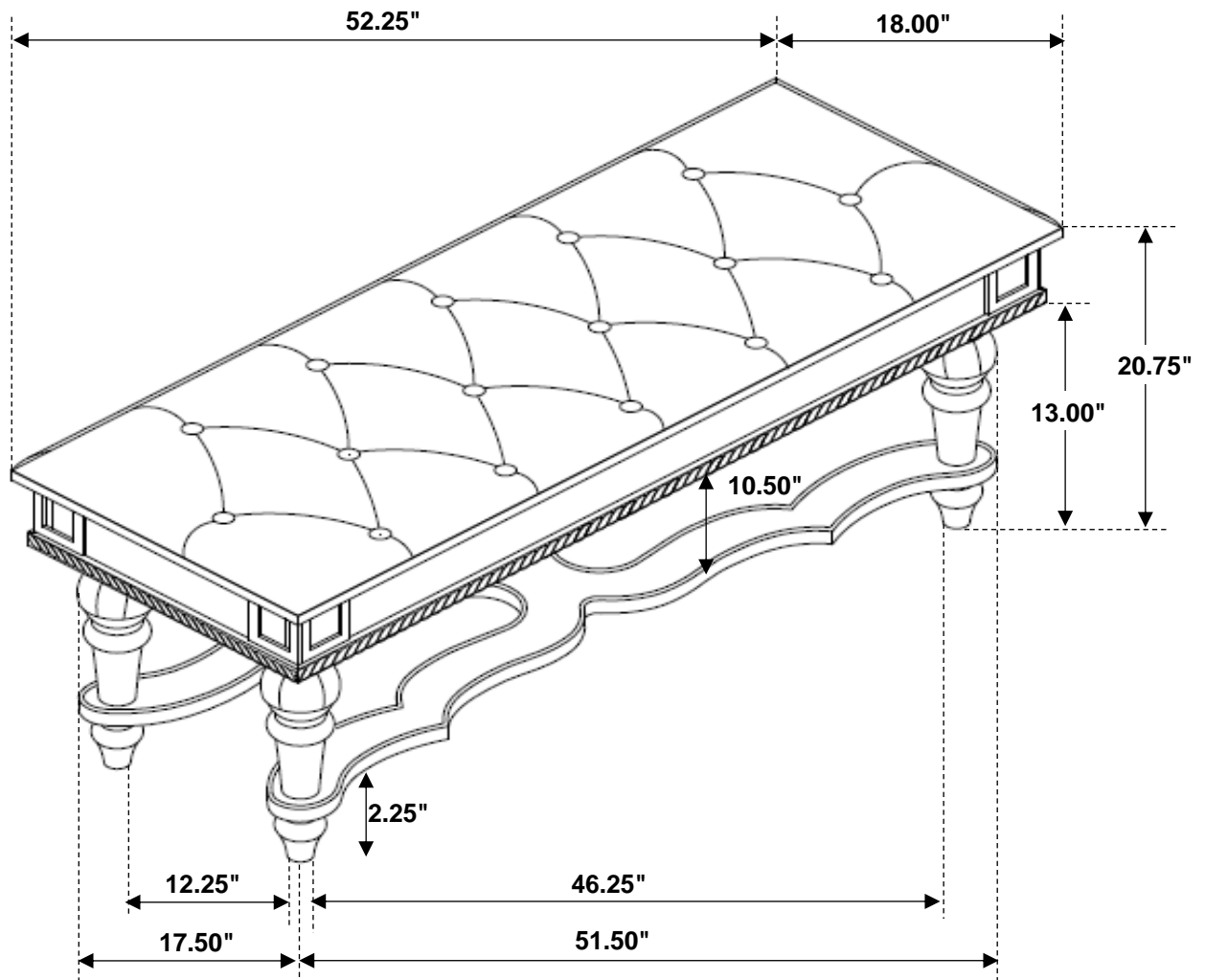

Note: Dimension tolerance $\pm 5\%$