

ASSEMBLY INSTRUCTION
(Instructions de montage)

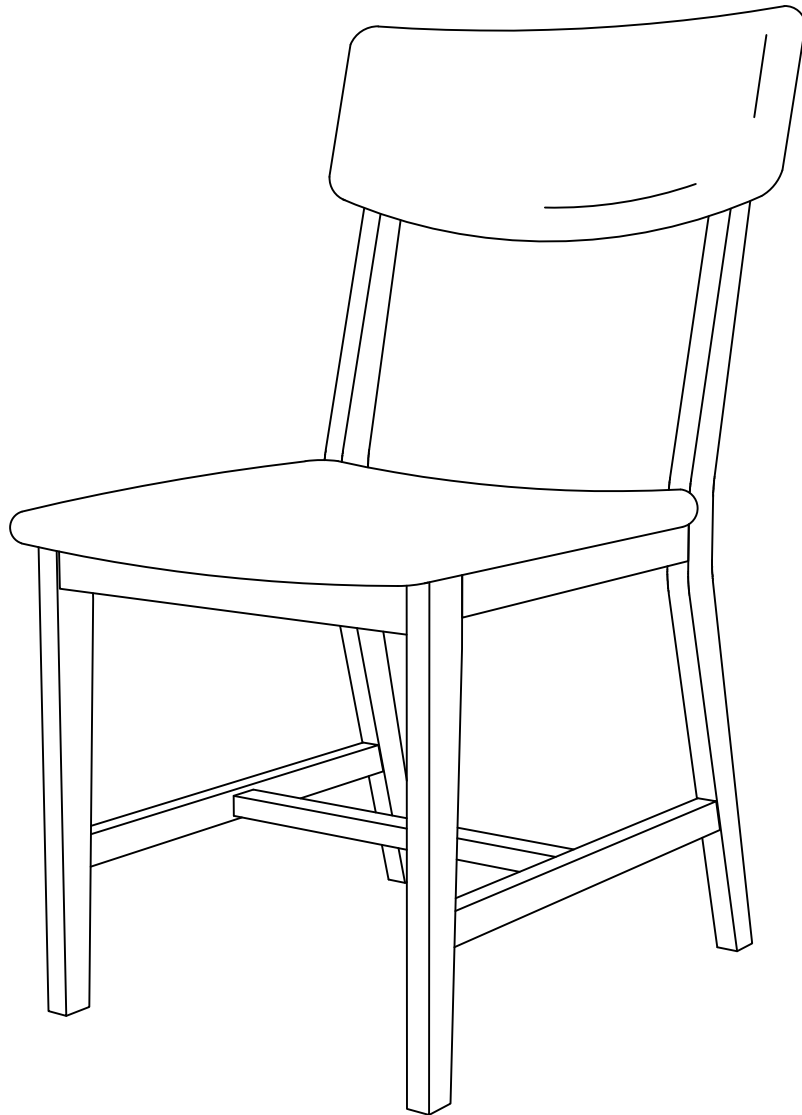

NOTE: 50% TIGHTEN BEFORE FIXING ALL BOLTS
(REMARQUE : SERRER 50% AVANT DE FIXER TOUS LES BOULONS)

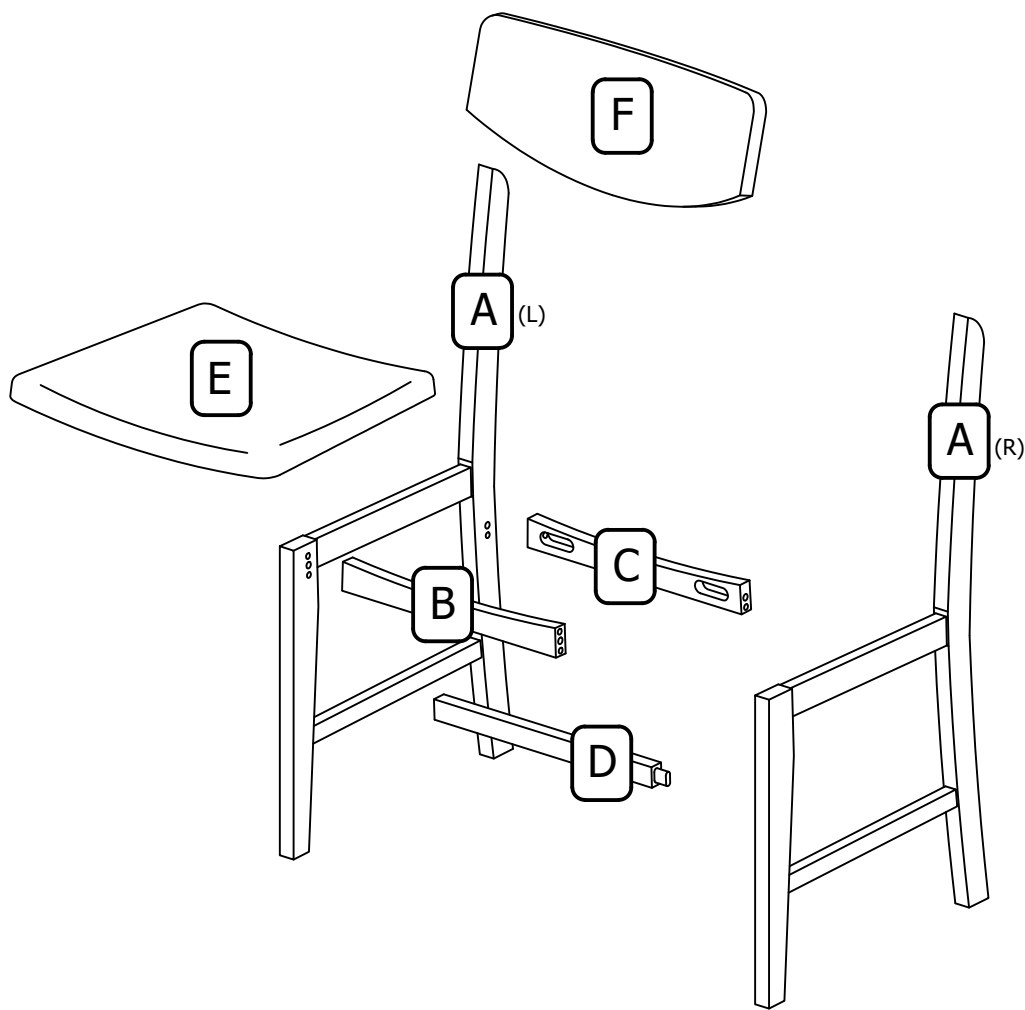

Notice:

1 50% Tighten before fixing all screws, Allen wrench is recommended instead of an electric drill.

2 Place the item on a flat ground to adjust and make sure it remains
3 stable.



4 Tighten up all screws with tools gradually.

If the screws are not aligned with holes during assembly, please loosen
5 all the other screws to 50% and continue the assembly process.

If the item is not stable, please loosen all the screws, adjust it on a flat
6 ground and tighten up all screws again.

Note : If one or some screws are fully tightened during assembly, chances are the others will not be aligned with holes. In addition, all the holes are designed to be relatively larger to provide more space for the adjustment of the screws.

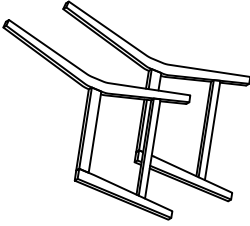

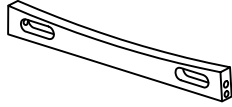
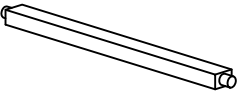
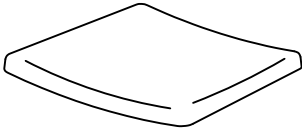
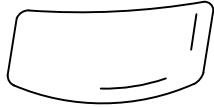

PART LIST

<div style="border: 1px solid black; padding: 5px; width: 40px; margin: 0 auto;">A</div>  <p style="text-align: center;">Chair Leg (2PCS) R&L Pied de chaise (2PCS) R&L</p>	<div style="border: 1px solid black; padding: 5px; width: 40px; margin: 0 auto;">B</div>  <p style="text-align: center;">Front Apron (1PC) Traverse avant (1PC)</p>	<div style="border: 1px solid black; padding: 5px; width: 40px; margin: 0 auto;">C</div>  <p style="text-align: center;">Back Apron (1PC) Traverse arrière (1PC)</p>
<div style="border: 1px solid black; padding: 5px; width: 40px; margin: 0 auto;">D</div>  <p style="text-align: center;">Leg Support (1PC) Support de jambe (1PC)</p>	<div style="border: 1px solid black; padding: 5px; width: 40px; margin: 0 auto;">E</div>  <p style="text-align: center;">Cushion Seat (1PC) Siège coussiné (1PC)</p>	<div style="border: 1px solid black; padding: 5px; width: 40px; margin: 0 auto;">F</div>  <p style="text-align: center;">Cushion Back (1PC) Dossier coussiné (1PC)</p>

HARDWARE LIST

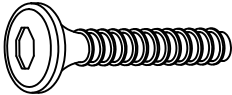
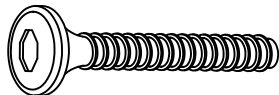
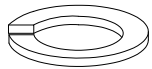
TOOLS REQUIRED (Not provided)

 Screwdriver

<div style="border: 1px solid black; padding: 5px; width: 40px; margin: 0 auto;">1</div>  <p style="text-align: center;">Allen Key M4 (1PC) Clé Allen M4 (1PC)</p>	<div style="border: 1px solid black; padding: 5px; width: 40px; margin: 0 auto;">2</div>  <p style="text-align: center;">JCBC M6 x 28 (4PCS) Boulon JCBC M6 x 28 (4PCS)</p>	<div style="border: 1px solid black; padding: 5px; width: 40px; margin: 0 auto;">3</div>  <p style="text-align: center;">JCBC M6 x 40 (4PCS) Boulon JCBC M6 x 40 (4PCS)</p>	<div style="border: 1px solid black; padding: 5px; width: 40px; margin: 0 auto;">4</div>  <p style="text-align: center;">Spring Washer M6 x 13 (4PCS) Rondelle élastique M6 x 13 (4PCS)</p>
<div style="border: 1px solid black; padding: 5px; width: 40px; margin: 0 auto;">5</div>  <p style="text-align: center;">Wood Dowel M8 x 30 (6PCS) Cheville en bois M8 x 30 (6PCS)</p>	<div style="border: 1px solid black; padding: 5px; width: 40px; margin: 0 auto;">6</div>  <p style="text-align: center;">CSK Screw M4 x 30 (4PCS) Vis fraisée M4 x 30 (4PCS)</p>	<div style="border: 1px solid black; padding: 5px; width: 40px; margin: 0 auto;">7</div>  <p style="text-align: center;">Wood Button 14.5 (4PCS) Bouchon en bois 14.5 (4PCS)</p>	<div style="border: 1px solid black; padding: 5px; width: 40px; margin: 0 auto;">8</div>  <p style="text-align: center;">CSK Screw M4 x 28 (2PCS) Vis fraisée M4 x 28 (2PCS)</p>



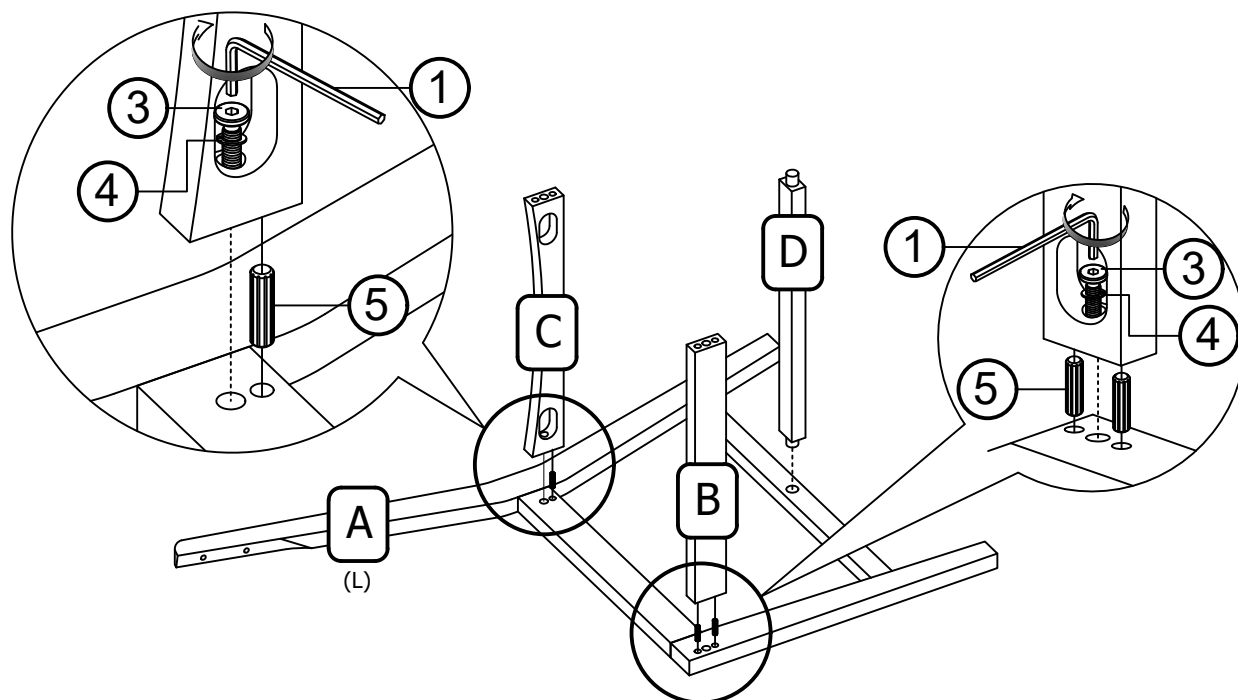

STEP 1

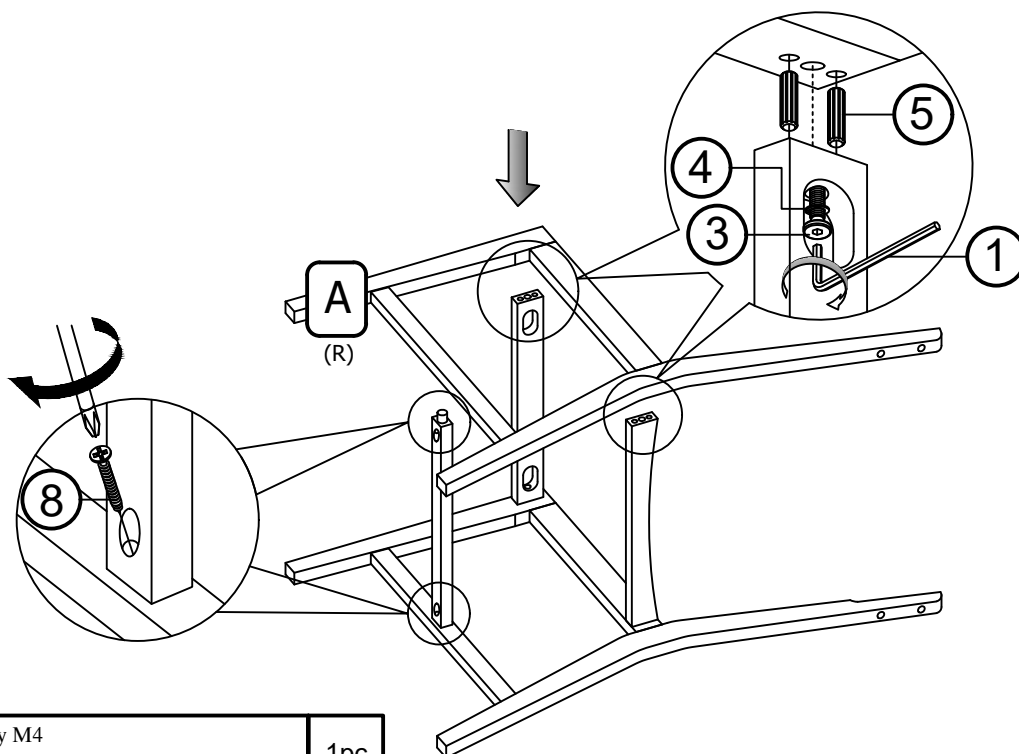

1		Allen Key M4 Clé Allen M4	1pc	4		Spring Washer M6 Rondelle élastique M6	2pcs
3		JCBC SCREW M6 X 40MM Boulon JCBC M6 x 40	2pcs	5		Wood Dowel M8 30 Cheville en bois M8 x 30	3pcs

STEP 2



1		Allen Key M4 Clé Allen M4	1pc				
3		JCBC SCREW M6 X 40MM Boulon JCBC M6 x 40	2pcs	5		Wood Dowel M8 30 Cheville en bois M8 x 30	3pcs
4		Spring Washer M6 Rondelle élastique M6	2pcs	8		Csk Screw M4 X 28 Vis fraisée M4 x 28	2pcs

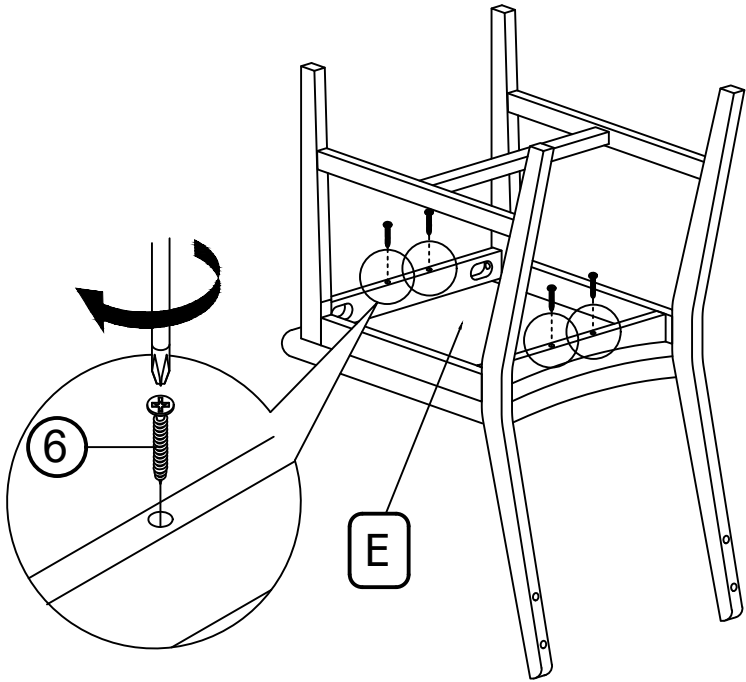

STEP 3

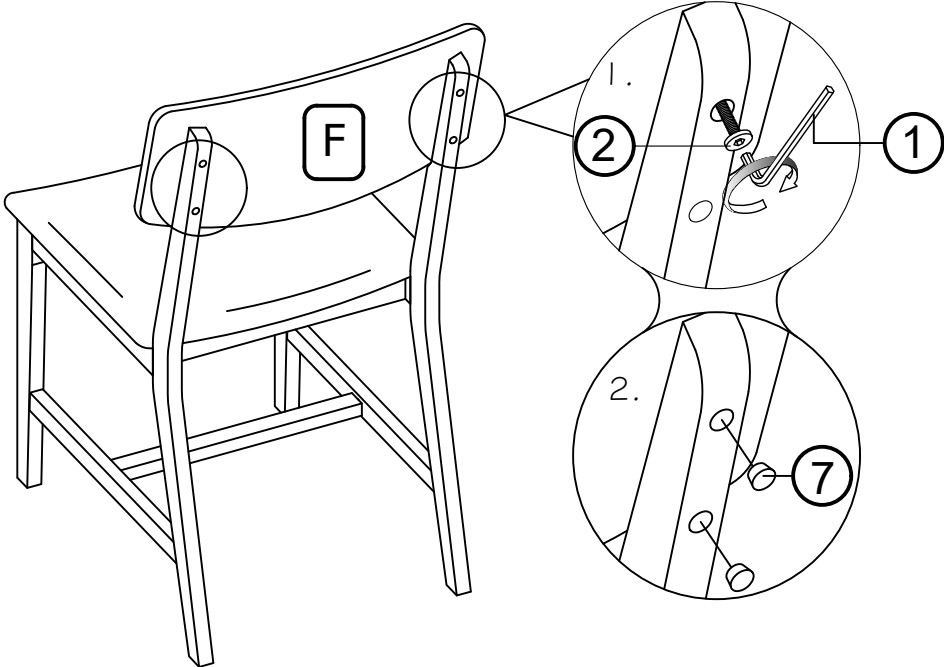

6		Csk Screw M4 X 30 Vis fraisée M4 x 30	4pcs
---	---	--	------

STEP 4



1		Allen Key M4 Clé Allen M4	1pc
2		JCBC SCREW M6 X 28MM Boulon JCBC M6 x 28	4pcs
7		Wood Button 14.5 Bouchon en bois 14.5	4pcs