

Storage Shelving

Instruction Manual

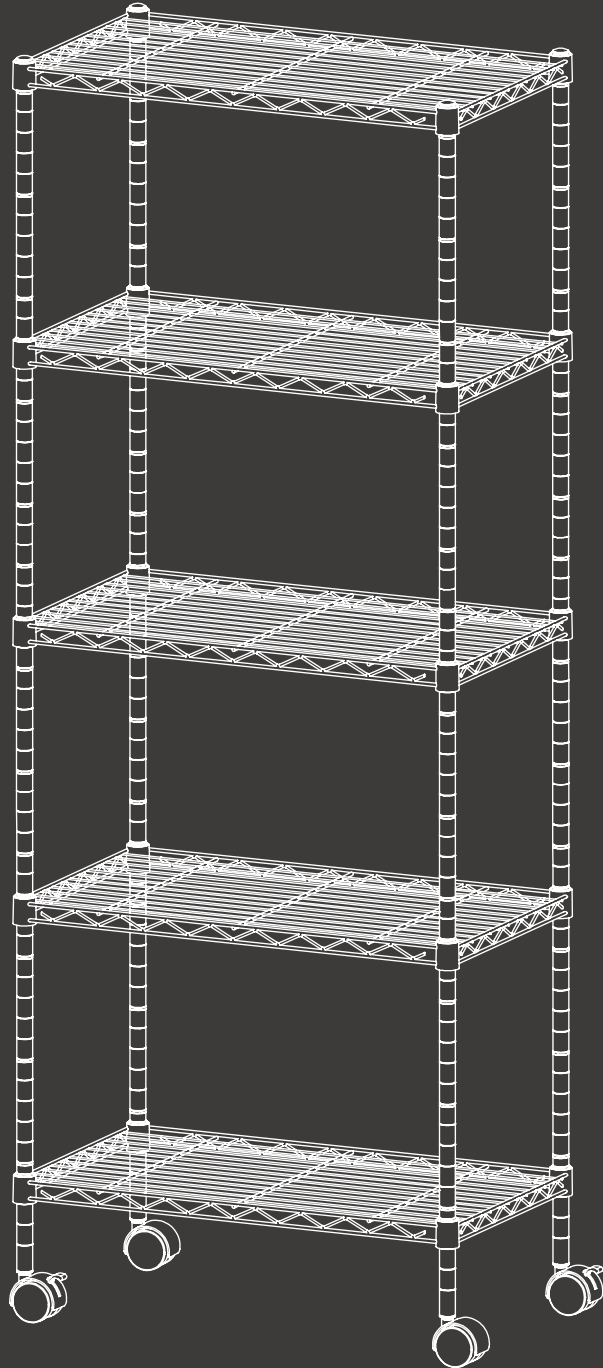

Product Diagram

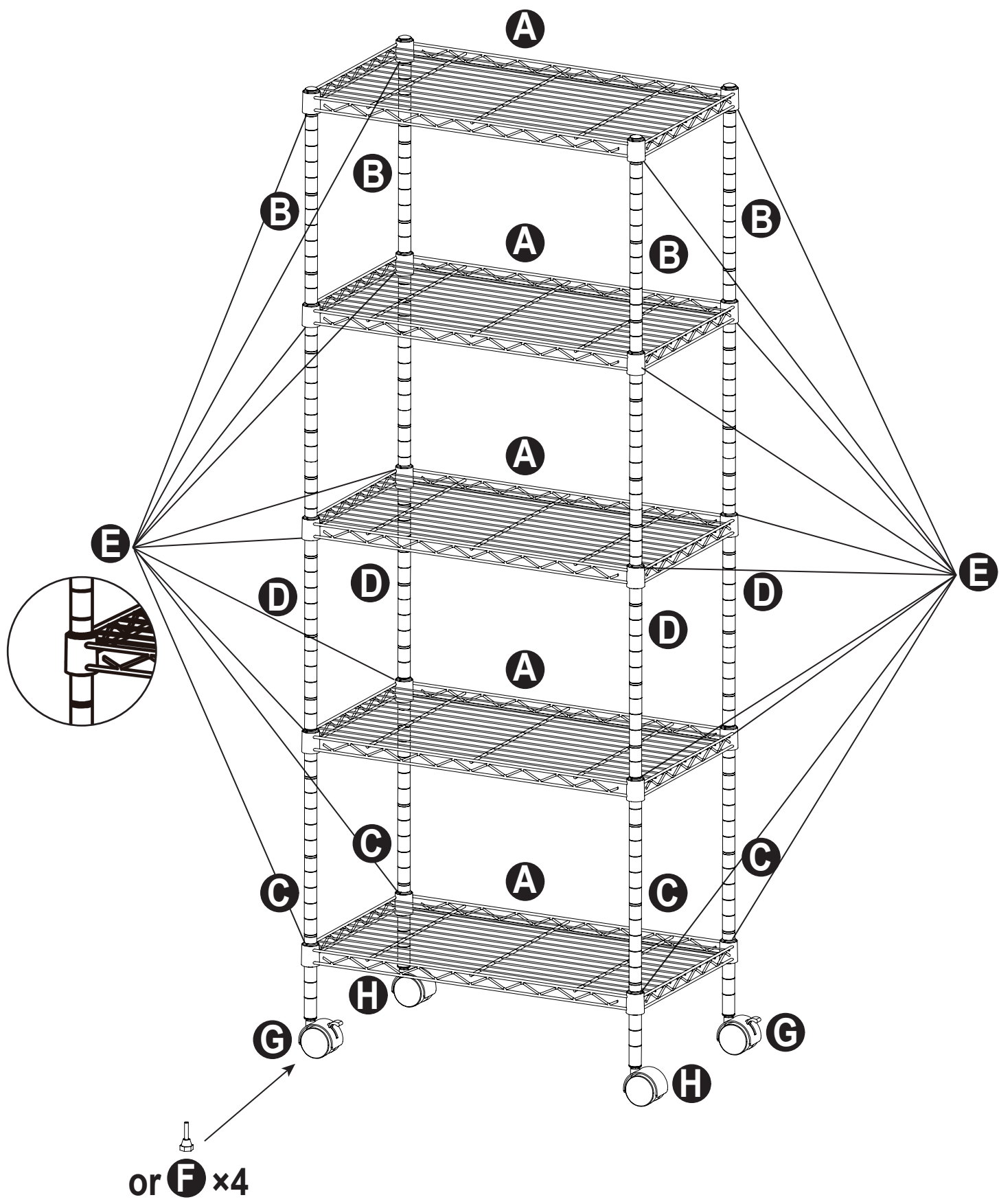

Parts List

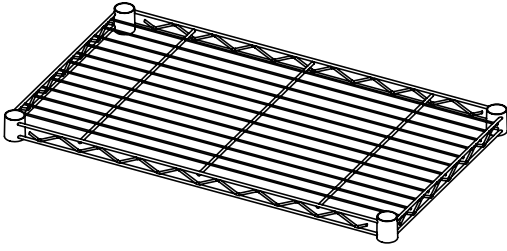

A Shelf ×5



B Top Post ×4



C Bottom Post ×4

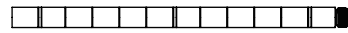

D Middle Post ×4



E Plastic Split Sleeves ×40+2

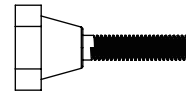

F Levelling Foot ×4

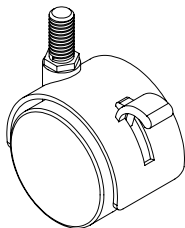

G Locking Wheel ×2

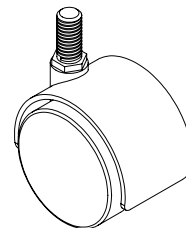

H Wheel ×2

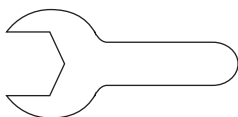

I Wrench ×1

Assembly Instruction

Step 1

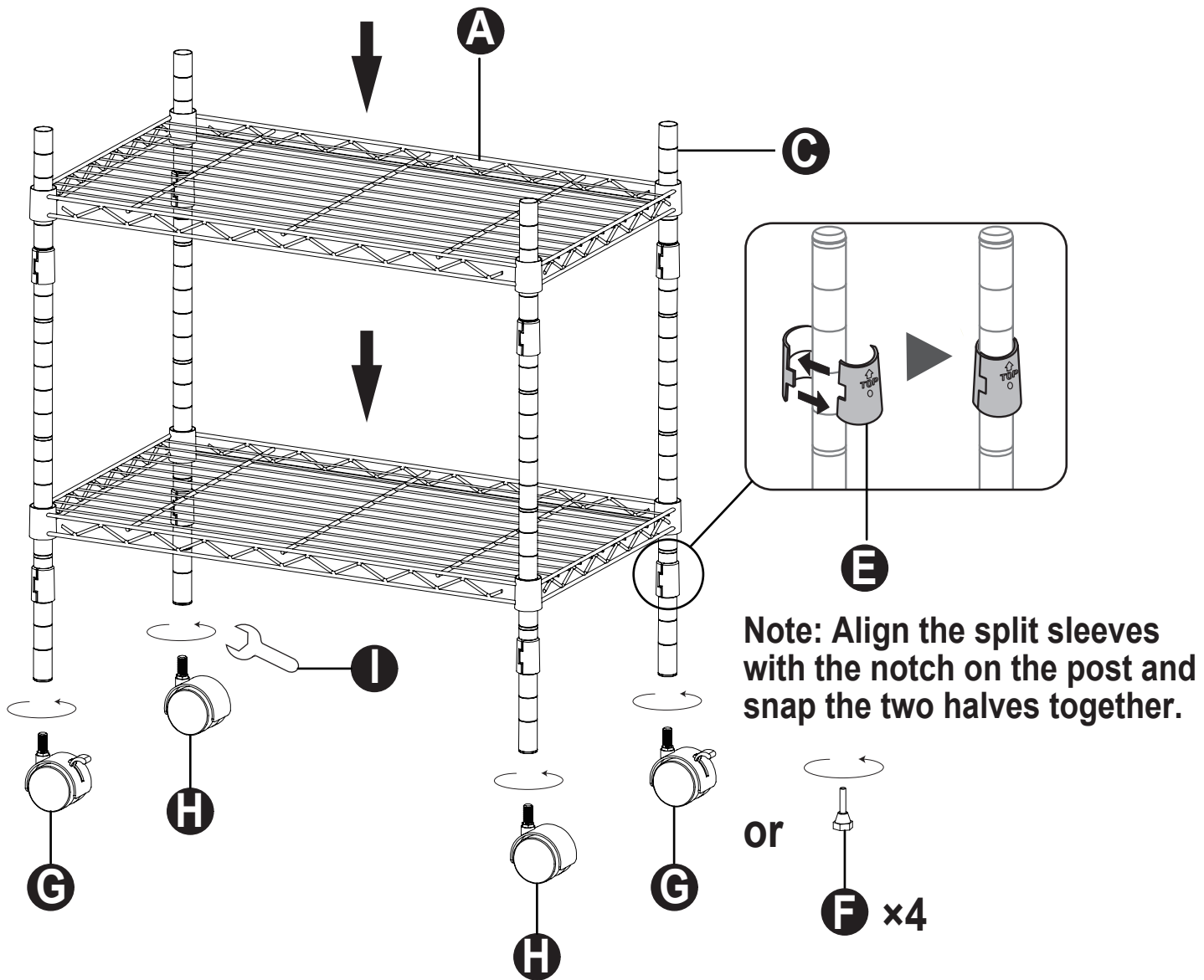

Attach a pair of Plastic Split Sleeves (E) around the end of Bottom Post (C). And slide Shelf (A) onto the Plastic Split Sleeves (E). Then do it again at the top of Bottom Post (C) as shown. Attach Bottom Post (C) to the wheels (H&G) or Levelling Foot (F).

Step 2

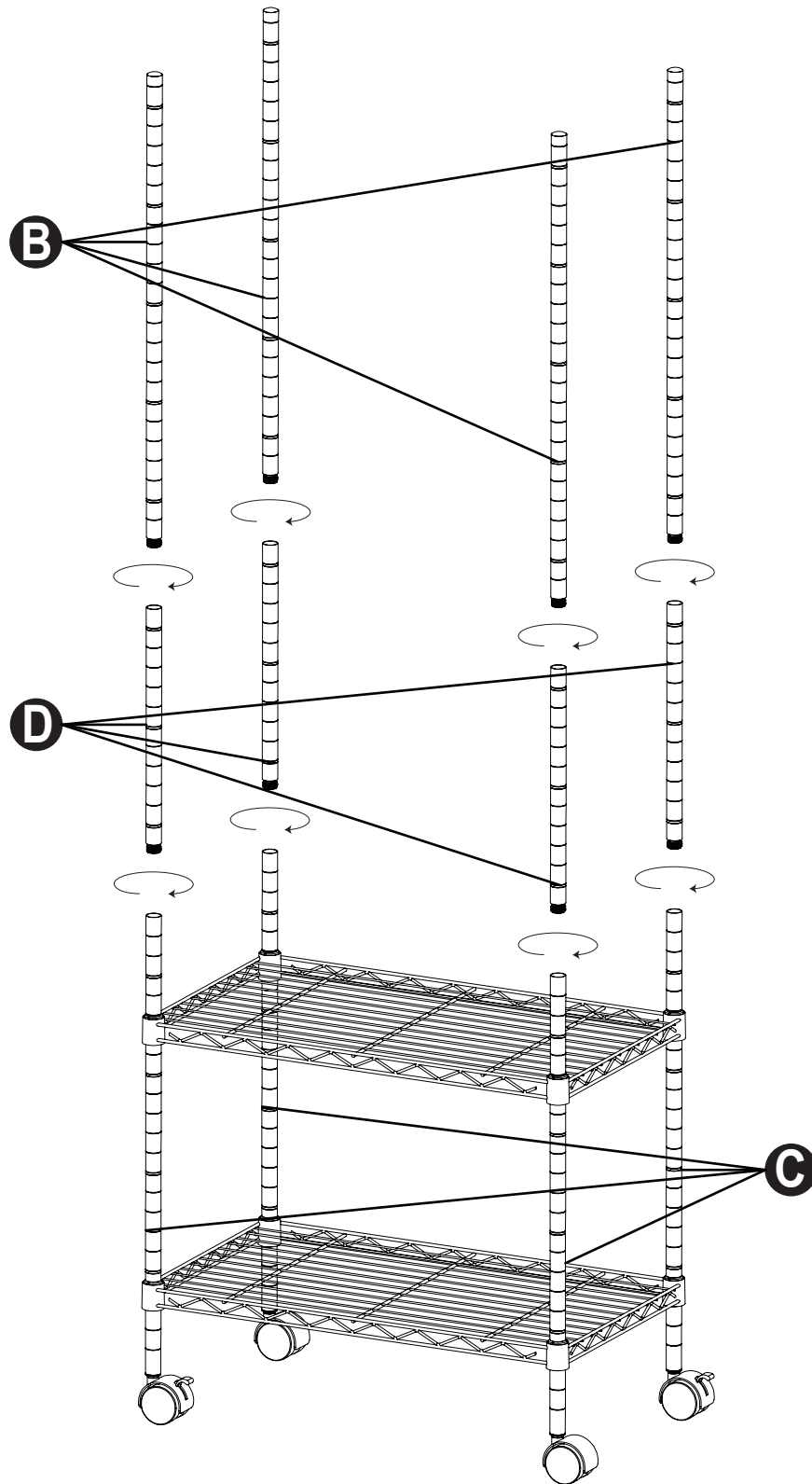

Attach Top Post **B** to Middle Post **D** and attach Middle Post **D** to Bottom Post **C**.

Step 3

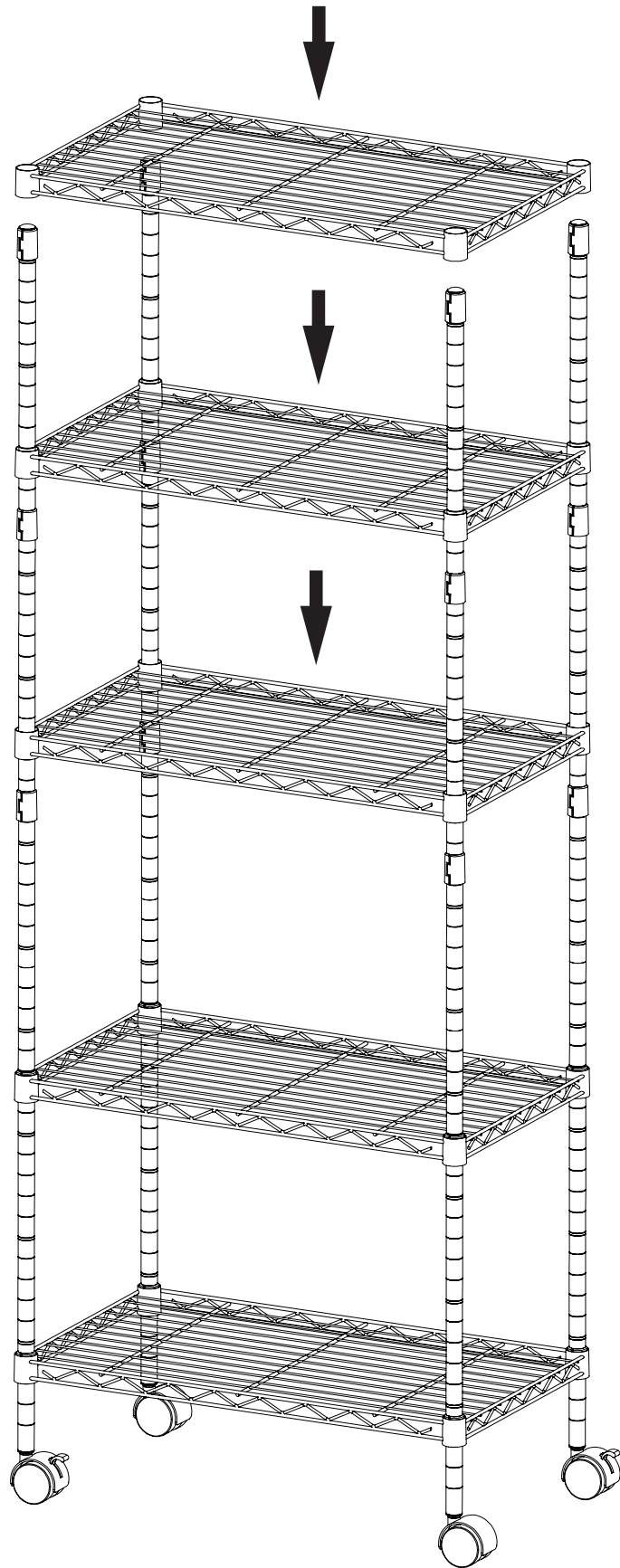

Assemble the rest of the shelves according to step 1.

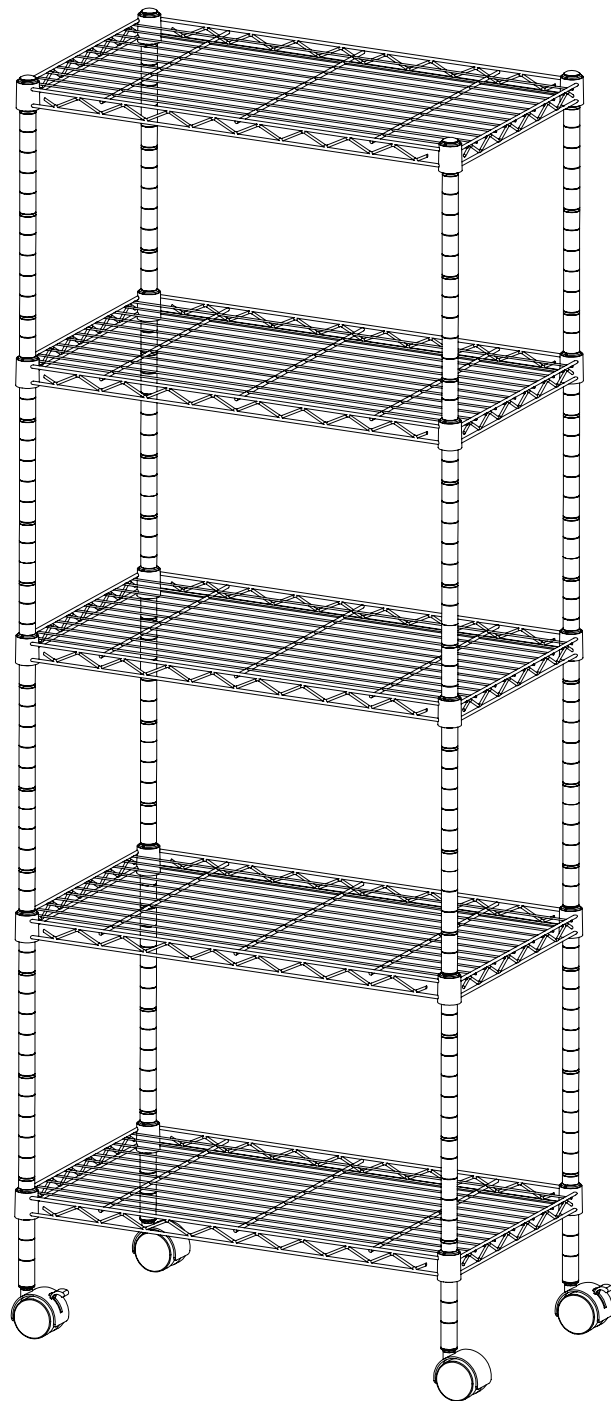

Thank you for choosing this product. We strive to provide you with the best quality products and service in the industry. Should you have any issues, please don't hesitate to contact us.