





CARE AND MAINTENANCE

Always use felt pads under all articles to prevent discoloration or softening of the lacquer. Plastic and rubber bases on items can discolor wood. Wipe up spills immediately and avoid common hazards such as hot dishes, harsh solvents and abrasives. Cleaning should be done with a soft lint free cotton cloth dampened with water or furniture polish. On highly used surfaces we recommend applying a quality paste wax which should be used on a regular basis to provide additional protection from scratches and spills. How often you apply the wax depends on how much wear the furniture receives.

NOTICE

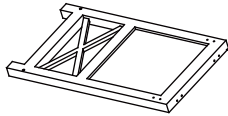
- * Please make sure that you have all parts indicated before you begin assembly on this item.
- * This item should be assembled on a soft surface to prevent scratching/dirty the surface during assembly.
- * This item may require periodic tightening.

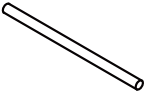
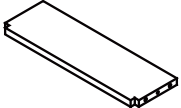
Part List and Hardware List

PIECE	DESCRIPTION	PICTURE	QUANTITY
A	Left Side Panel		1X
B	Hanger Rail		2X
C	Towel Rail		2X
D	Cross Bar		1X
E	Right Hanger Rail		1X



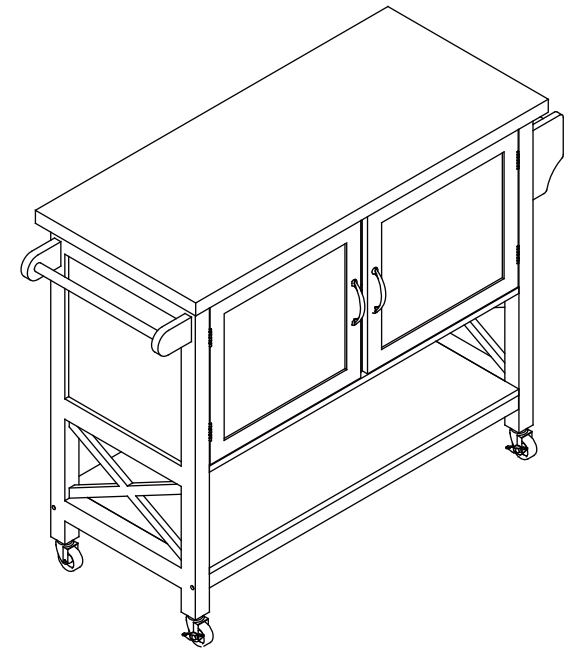

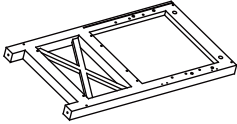
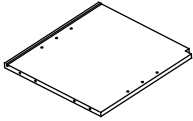
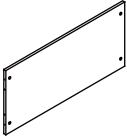
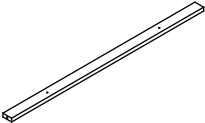
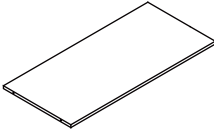
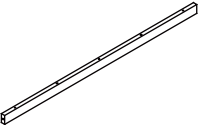
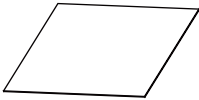
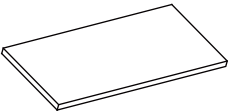

Item Dimension: W45.7" x D17.3" x H35.6"
 Item Weight Capacities:
 Top Panel: 55LBS Shelf: 11LBS

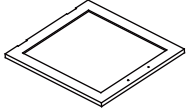
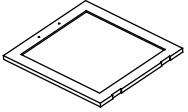
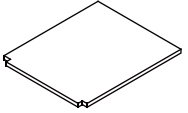
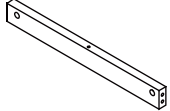

Part List and Hardware List

PIECE	DESCRIPTION	PICTURE	QUANTITY
F	Left Hanger Rail		1X
G	Right Side Panel		1X
H	Partition		1X
I	Shelf		1X
J	Stretcher		1X
K	Bottom Panel		1X
L	Stretcher		2X
M	Back Panel		2X
N	Top Panel		1X







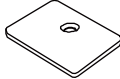

Part List and Hardware List

PIECE	DESCRIPTION	PICTURE	QUANTITY
O	Right Door Panel		1X
P	Left Door Panel		1X
Q	Shelf		2X
R	Cross Bar		1X
HW1	Socket Screw (M5x50mm)		6X
HW2	Allen Key		1X
HW3	Cam Bolt		16X
HW4	Cam Lock		16X
HW5	Dowel		30X

Part List and Hardware List

PIECE	DESCRIPTION	PICTURE	QUANTITY
HW6	Socket Bolt (M6x25mm)		9X
HW7	Magnet		2X
HW8	Phillips Screw (M3x15mm)		4X
HW9	Bolt Nut		8X
HW10	Socket Bolt (M6x65mm)		8X
HW11	Wheel (with brake)		2X
HW12	Wheel		2X
HW13	Wrench		1X
HW14	Phillips Screw (M4x25mm)		2X

Part List and Hardware List

PIECE	DESCRIPTION	PICTURE	QUANTITY
HW15	Bracket		2X
HW16	Hinge		4X
HW17	Phillips Screw (M3x12mm)		2X
HW18	Handle		2X
HW19	Phillips Screw (M4x20mm)		4X
HW20	Pin		8X
HW21	Buckle		4X
HW22	Phillips Screw (M3x15mm)		4X
HW23	Phillips Screw (M4x14mm)		24X

PREPARATION

Before beginning assembly of product, make sure all parts are present. Compare parts with package contents list. If any part is missing or damaged, do not attempt to assemble the product.

Estimated Assembly Time: 15 minutes.



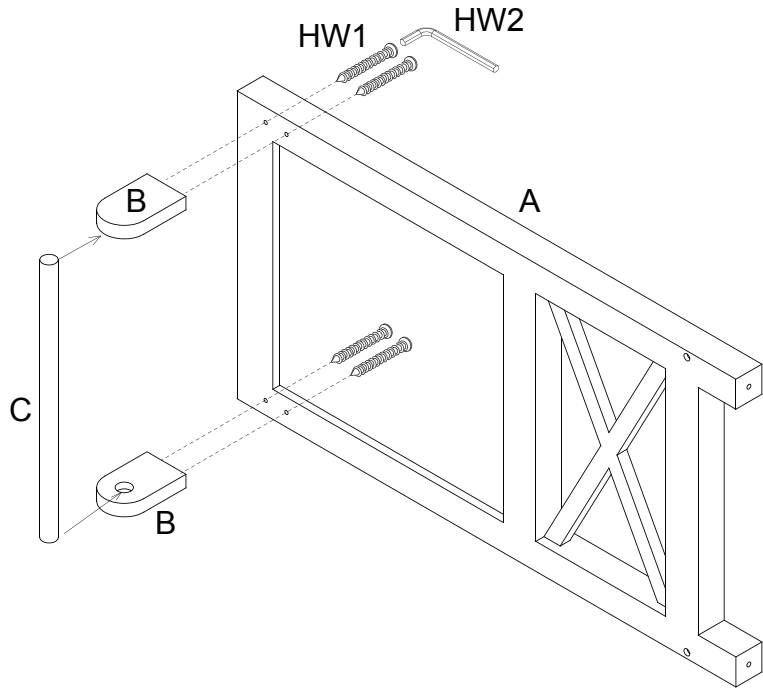

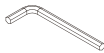

1

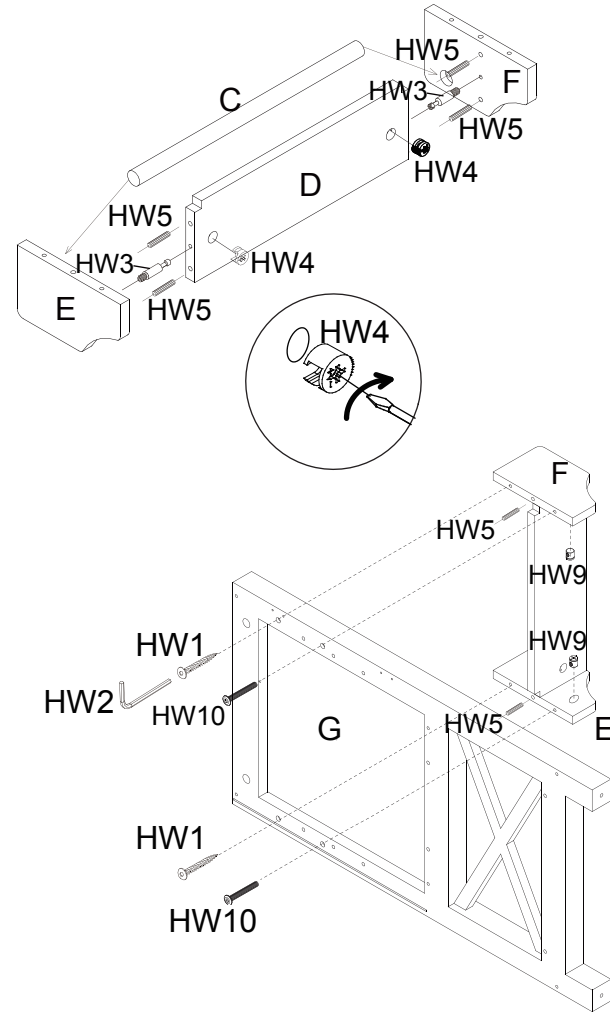

HW1 x4	
HW2 x1	

2



HW1 x2		HW5 x6	
HW3 x2		HW9 x2	
HW4 x2		HW10 x2	





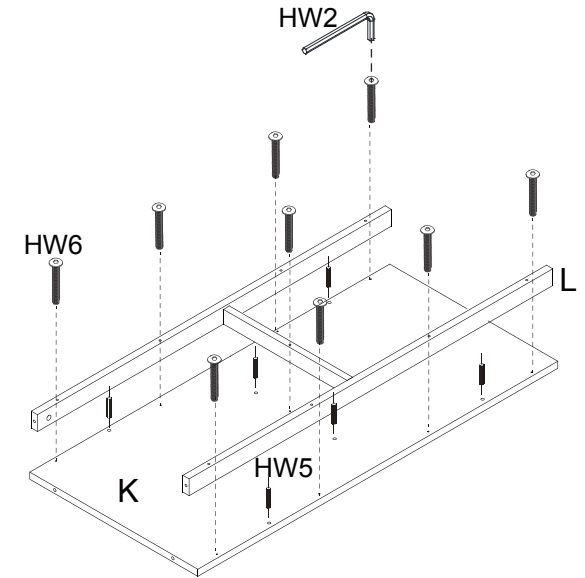
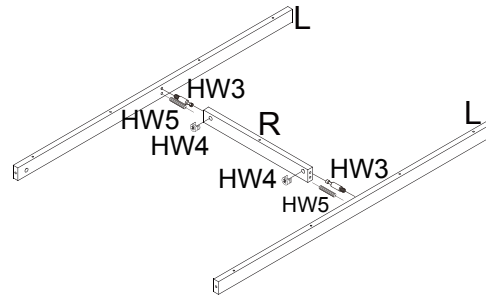
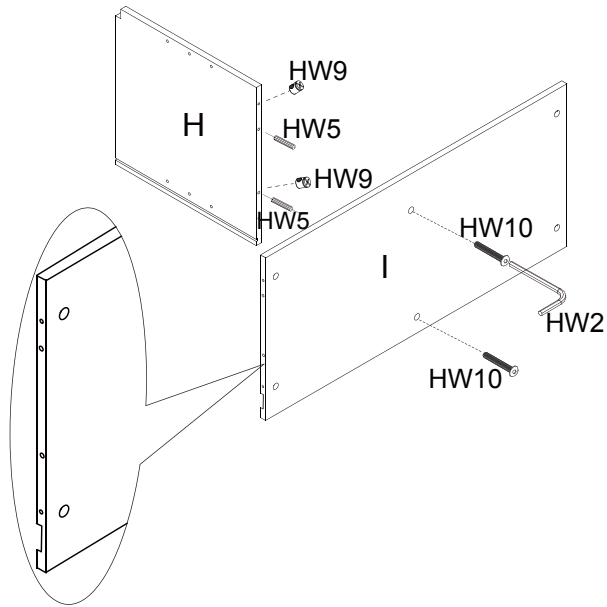

PREPARATION

Before beginning assembly of product, make sure all parts are present. Compare parts with package contents list. If any part is missing or damaged, do not attempt to assemble the product.

Estimated Assembly Time: 15 minutes.

3



HW3 x2		HW6 x9	
HW4 x2		HW9 x2	
HW5 x10		HW10 x2	

PREPARATION

Before beginning assembly of product, make sure all parts are present. Compare parts with package contents list. If any part is missing or damaged, do not attempt to assemble the product.

Estimated Assembly Time: 15 minutes.

4

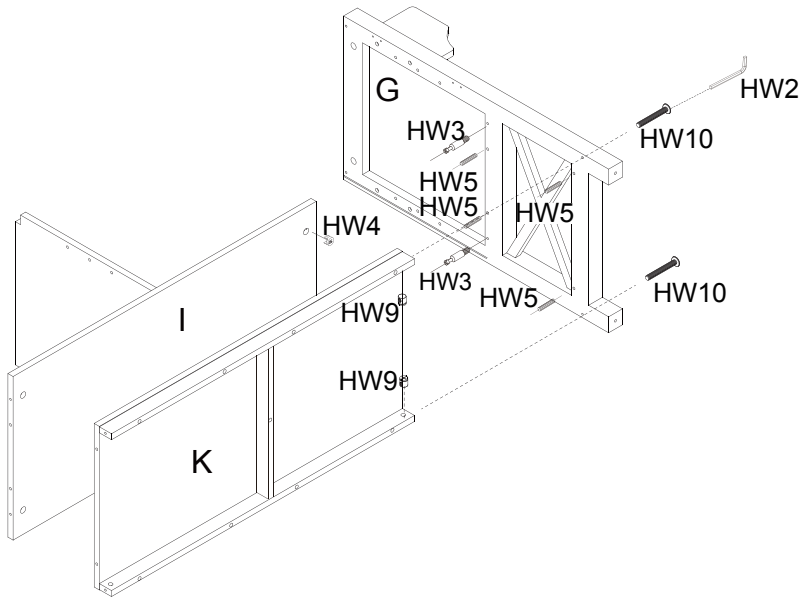

		HW5 x4	
HW3 x2		HW9 x2	
HW4 x2		HW10 x2	

5

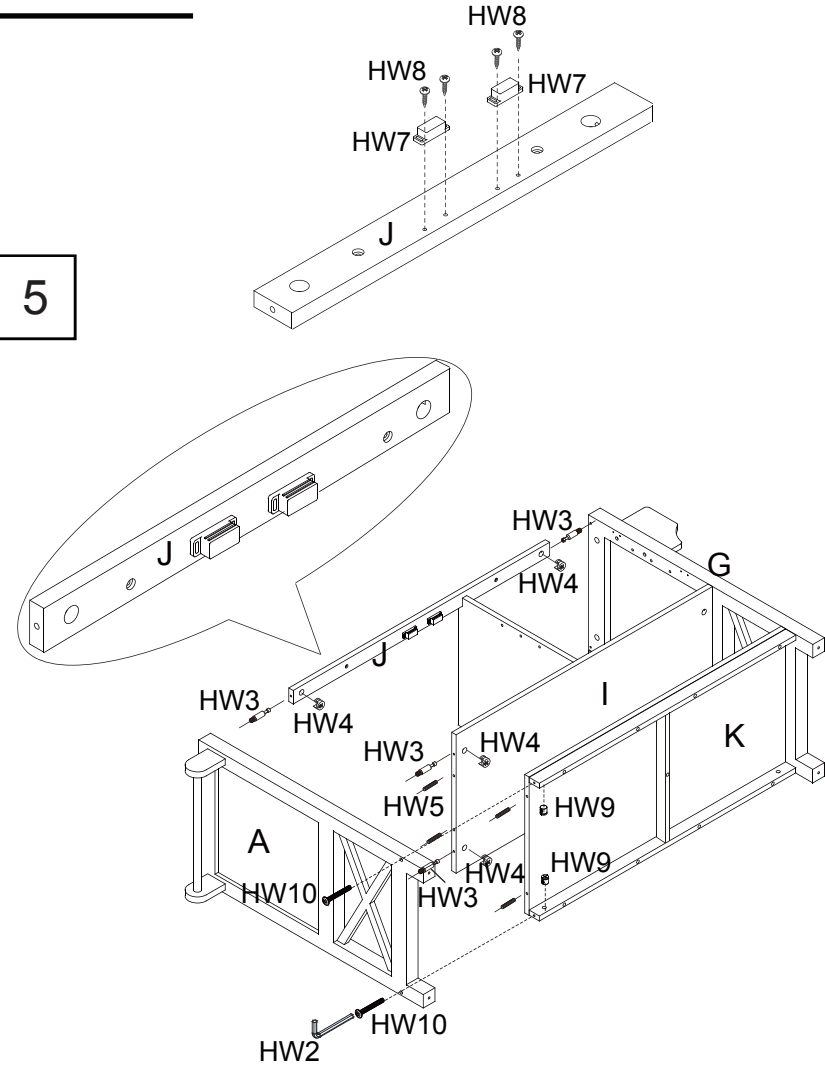

		HW4 x4		HW8 x4	
		HW5 x4		HW9 x2	
HW3 x4		HW7 x2		HW10 x2	



PREPARATION

Before beginning assembly of product, make sure all parts are present. Compare parts with package contents list. If any part is missing or damaged, do not attempt to assemble the product.

Estimated Assembly Time: 15 minutes.

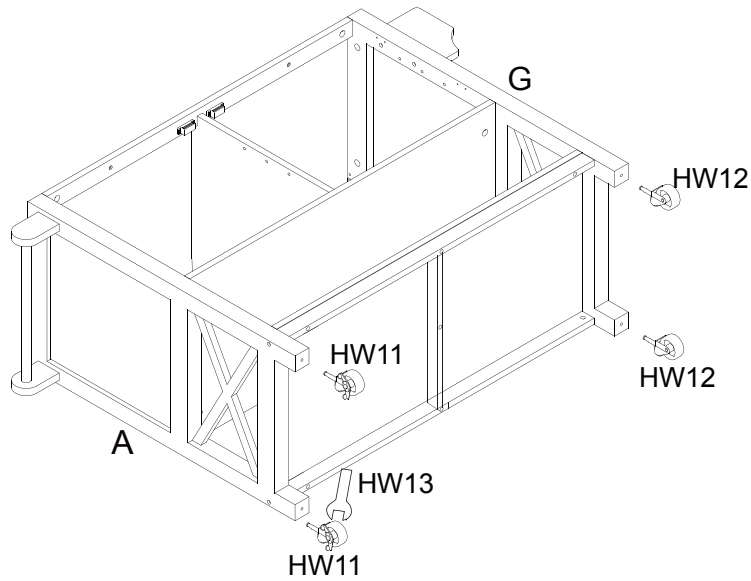

6

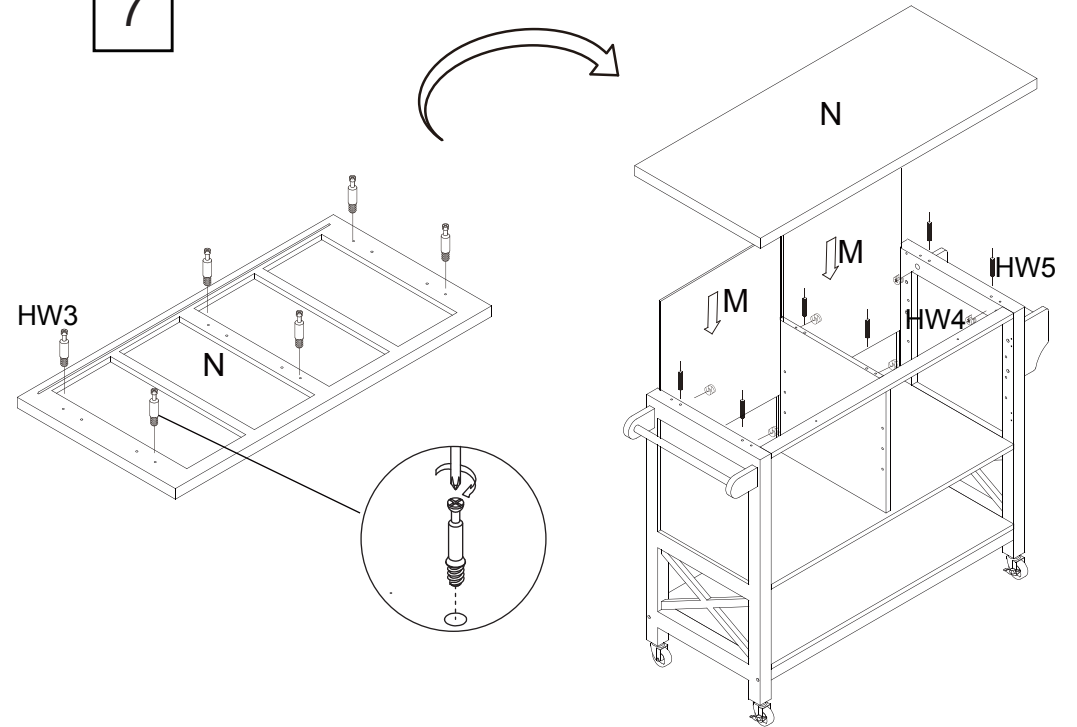

HW11 x2	
HW12 x2	
HW13 x1	

7



HW3 x6	
HW4 x6	
HW5 x6	

PREPARATION

Before beginning assembly of product, make sure all parts are present. Compare parts with package contents list. If any part is missing or damaged, do not attempt to assemble the product.

Estimated Assembly Time: 15 minutes.



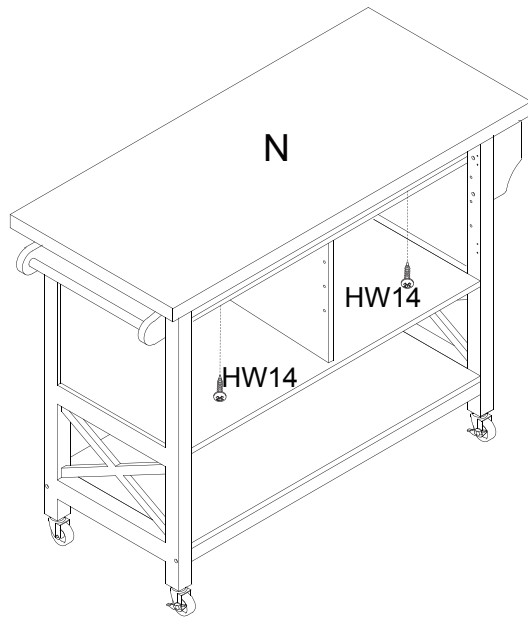
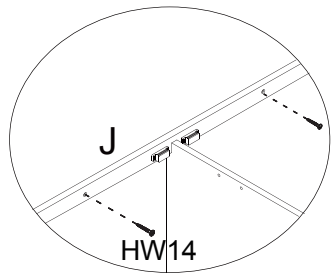



8

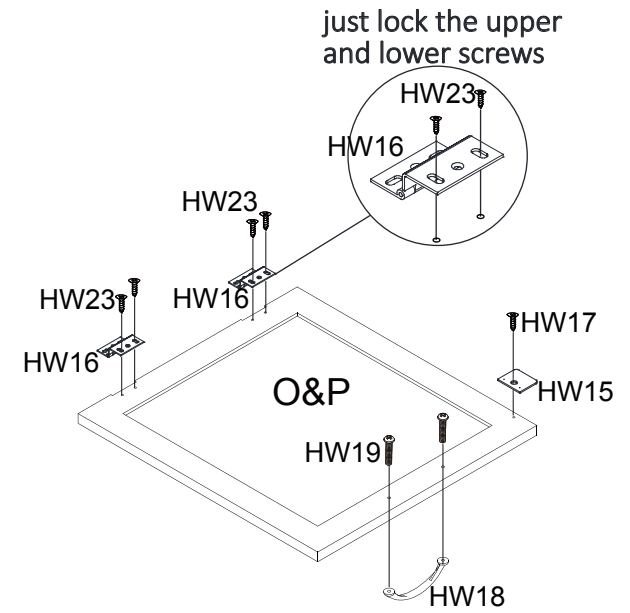

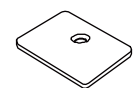
HW14 x2	
------------	--

9



HW15 x2		HW18 x2	
HW16 x4		HW19 x4	
HW17 x2		HW23 x8	

PREPARATION

Before beginning assembly of product, make sure all parts are present. Compare parts with package contents list. If any part is missing or damaged, do not attempt to assemble the product.



Estimated Assembly Time: 15 minutes.

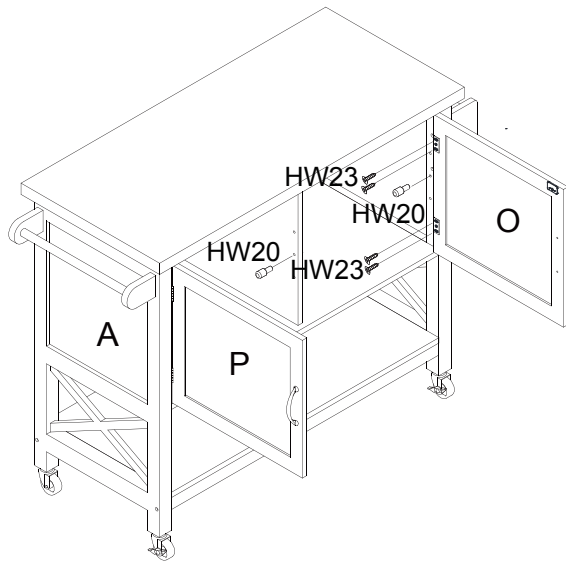

10

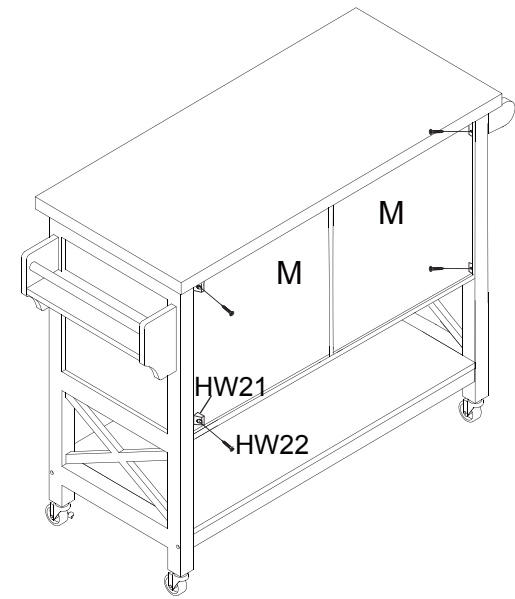
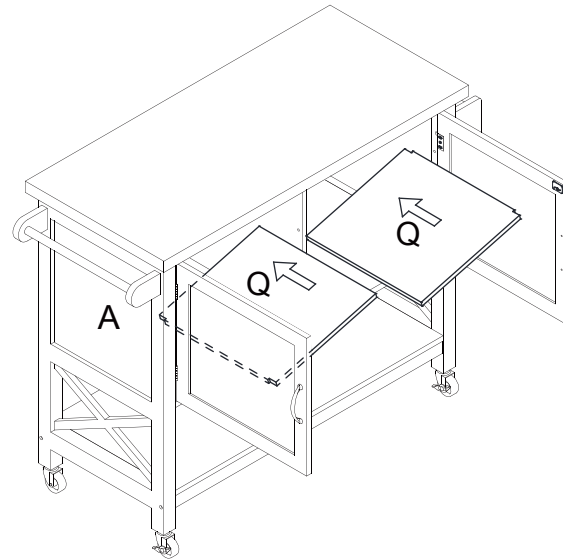

11



HW20 x8	
HW23 x8	

HW21 x4	
HW22 x4	

PREPARATION

Before beginning assembly of product, make sure all parts are present. Compare parts with package contents list. If any part is missing or damaged, do not attempt to assemble the product.

EstimatedAssemblyTime: 15 minutes.

NOTE:

Attention: If the doors may shift or sag after assembly, please adjust the hinges according to below instruction.

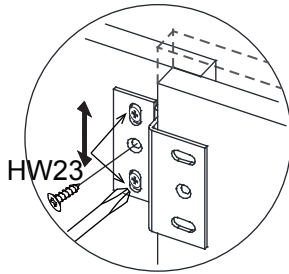
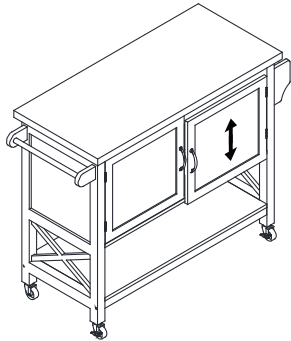

Vertically adjustment

Slightly adjust the screws position on side panels.

When the doors are flush, lock the middle screws on hinges.

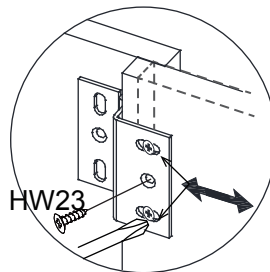
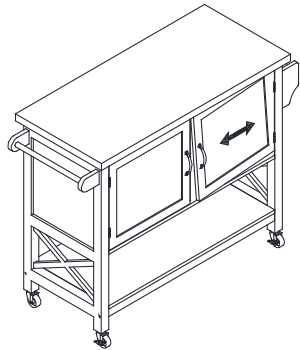

Horizontally adjustment

Slightly adjust the screws position on doors.

When the doors are flush, lock the middle screws on hinges.