

Magic²

The original invisible sliding doors system
Il sistema invisibile originale

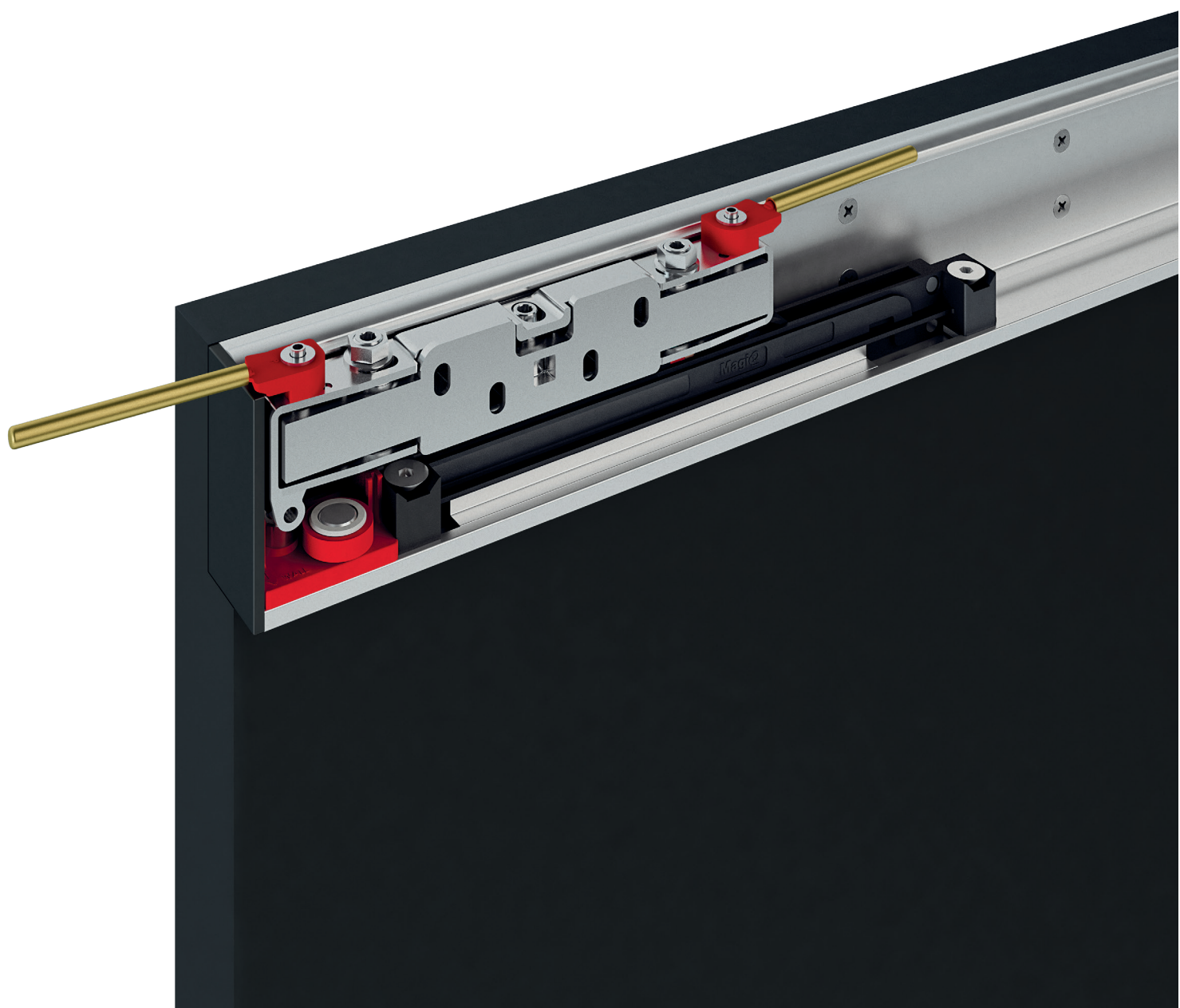

Tracks / Binari

ALUMINUM FINISHES CODES / CODICI FINITURE ALLUMINIO



8 ... 0.0

01 • (Anodized Silver / Argento - A)	13 • (Brushed Anodized Dark Brown / E3 Spazzolato - E3S)	17 • (Brushed Anodized Nickel / Nichel Spazzolato - NKS)
02 • (Brushed Anodized Silver / Argento Spazzolato - AS)	14 • (Anodized Black / Nero - N)	25 • (Brushed Anodized Graphite / Grafite Spazzolato - GRFS)
12 • (Anodized Dark Brown / E3 - E3)	15 • (Brushed Anodized Black / Nero Spazzolato - NS)	26 • (Anodized Graphite / Grafite - GRF)

01 - 02 STANDARD / 12 - 13 - 14 - 15 - 17 - 25 - 26 SPECIAL

Magic2

COMPLETE BOX KIT / KIT COMPLETO IN SCATOLA



K Complete kit / Kit completo

0031		Magic2 - Wood Magic2 - Legno
1		1100 mm
2		1800 mm
01		Standard Finish / Finitura Standard

Magic2 Frame

COMPLETE BOX KIT / KIT COMPLETO IN SCATOLA



K Complete kit / Kit completo

0461		1500 mm - 80kg
0462		1100 mm - 80kg
1		N.2 Soft damper stoppers N.2 Fermi ammortizzati
1		2200 mm
2		2600 mm
3		3000 mm
02		Brushed Anodized Silver / Argento Spazzolato
13		Brushed Anodized Dark Brown / E3 Spazzolato
15		Brushed Anodized Black / Nero Spazzolato
17		Brushed Anodized Nickel / Nichel Spazzolato
25		Brushed Anodized Graphite / Grafite Spazzolato

Magic2 Vetro

COMPLETE BOX KIT / KIT COMPLETO IN SCATOLA















K Complete kit / Kit completo

0041		1100 mm - 80kg
0042		1800 mm - 80kg
1		Glass thk. / Vetri sp. 8 mm (5/16")
2		Glass thk. / Vetri sp. 10 mm (3/8")
3		Glass thk. / Vetri sp. 12 mm (1/2")
02		Brushed Anodized Silver / Argento Spazzolato

Magic2 Mix

COMPLETE BOX KIT / KIT COMPLETO IN SCATOLA









K	Complete kit / Kit completo	
	.	
	0441	 Magic2 MIX UP
	0442	 Magic2 MIX DOWN
	0443	 Magic2 MIX UP
	0444	 Magic2 MIX DOWN
	.	
	1	 1100 mm → ←  38-40 mm
	2	 1800 mm → ←  38-40 mm
	3	 1100 mm → ←  42-44 mm
	4	 1800 mm → ←  42-44 mm
	.	
	02	Brushed Anodized Silver / Argento Spazzolato
	15	Brushed Anodized Black / Nero Spazzolato

Magic2 Uni

COMPLETE BOX KIT / KIT COMPLETO IN SCATOLA



K	Complete kit / Kit completo	
	.	
	0451	 40 mm - 30 kg
	0452	 44 mm - 30 kg
	0453	 40 mm - 80 kg
	0454	 44 mm - 80 kg
	.	
	1	 1100 mm
	2	 1800 mm
	.	
	02	Brushed Anodized Silver / Argento Spazzolato
	15	Brushed Anodized Black / Nero Spazzolato

EXAMPLE / ESEMPIO

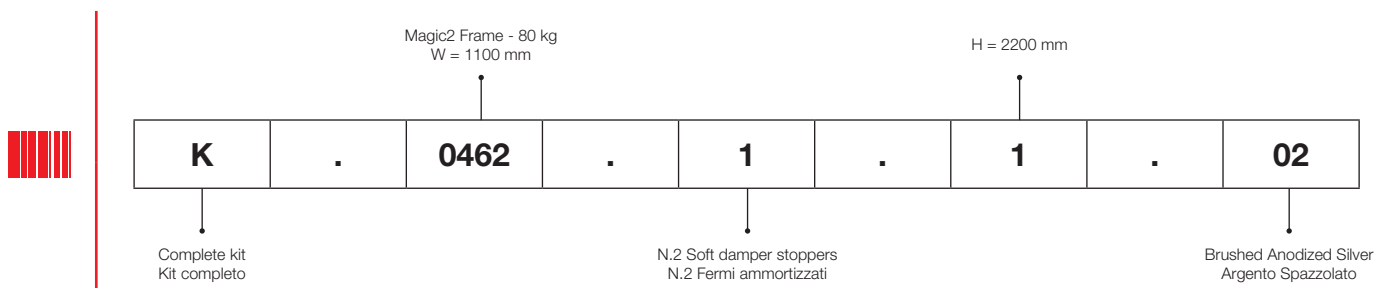

Magic2

PATENTED

Magic2 is the new **PATENTED** and **INVISIBLE** sliding door system outside the wall with soft-closing.

Magic2 è l'innovativo **SISTEMA INVISIBILE BREVETTATO** per porte scorrevoli esterno muro con fermi ammortizzati.





More than 50mm of damping motion

Magic2 system integrates new **PATENTED** dampers with 50 mm of braking motion, 20 mm longer than previous version of **Magic**, while keeping the same door dimensions.

Oltre 50 mm di frenatura

Il sistema **Magic2** integra nuovi fermi ammortizzati **BREVETTATI**, per una frenatura di oltre 50 mm, più di 20 mm rispetto al fermo del modello **Magic**, mantenendo gli stessi ingombri della porta.

PATENTED

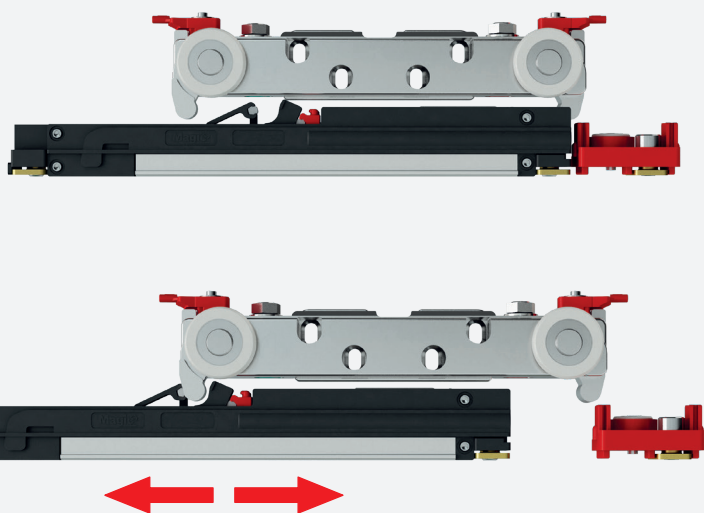
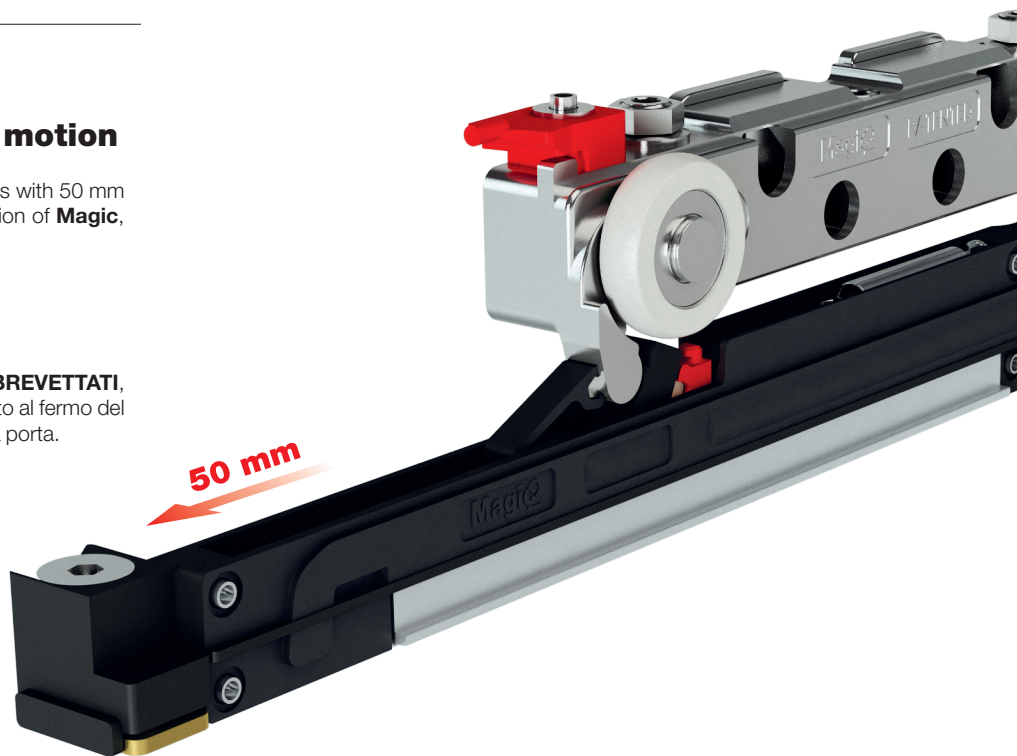

New dampers with adjustable positioning

New **Magic2** adjustable dampers were designed to be independent from wall-spacer wheels. New dampers are suitable to be moved into the track to allow door positioning adjustment.

Nuovi fermi con posizione regolabile

I nuovi fermi del **Magic2** sono stati progettati per essere indipendenti dal distanziale. All'occorrenza si possono spostare per regolare la posizione della porta.

New position of wall-spacer wheels

In **Magic2** system wall-spacer wheels are positioned on the door extremities. The wall-spacer wheels are so positioned in order to protect the door from wall contact, when wall surface are not plane.

Nuova posizione per le ruote distanziali

Nel sistema **Magic2** le ruote distanziali sono posizionate alle estremità della porta. Le ruote distanziali così posizionate proteggono la porta da contatti con la parete, in caso di muri con superfici irregolari.

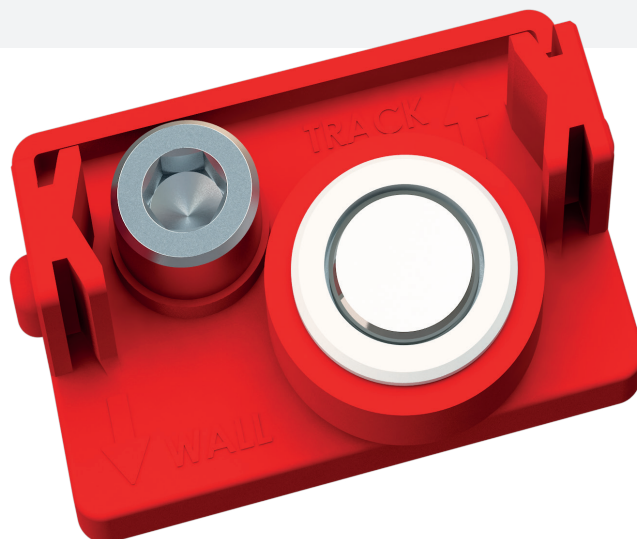

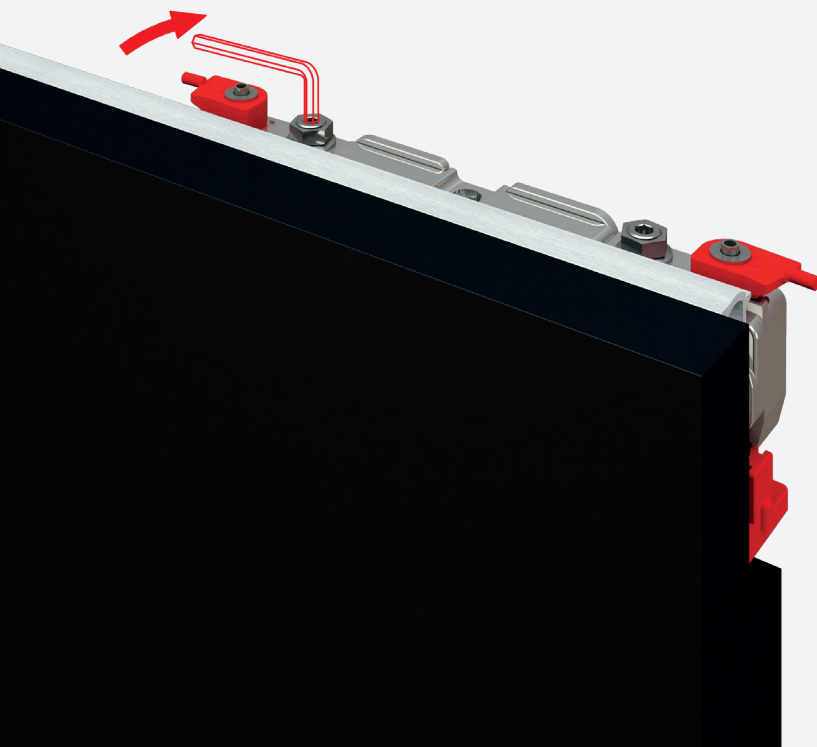

New patented adjustment system

New **Magic² PATENTED** sliding trolley integrates following door adjustments:

- Door height adjustment from floor
- Micrometric adjustment of door from wall
- Micrometric adjustment of door parallelism from wall

Door adjustments of wall distance and parallelism, are meant to compensate possible irregularities of wall. All adjustments are available in the top of sliding trolley, without removing the door.

Nuovo sistema brevettato di regolazione

Il nuovo scorrevole **Magic² BREVETTATO** integra le seguenti regolazioni:

- Regolazione dell'altezza della porta dal pavimento
- Regolazione micrometrica della distanza della porta dalla parete
- Regolazione micrometrica del parallelismo della porta rispetto alla parete

Le regolazioni di distanza e parallelismo della porta, si utilizzano per compensare eventuali irregolarità della parete. Tutte le regolazioni si realizzano dalla parte superiore dello scorrevole, senza sganciare la porta.

Practical anti-jumping system

Magic² sliding trolley includes two new turning anti-jumping activation elements. Turning anti-jumping activation elements are equipped with two safety levers, easy to rotate with no tools required. Safety levers, clearly visible, will have to be removed once anti-jumping system is activated in order to insert end caps.

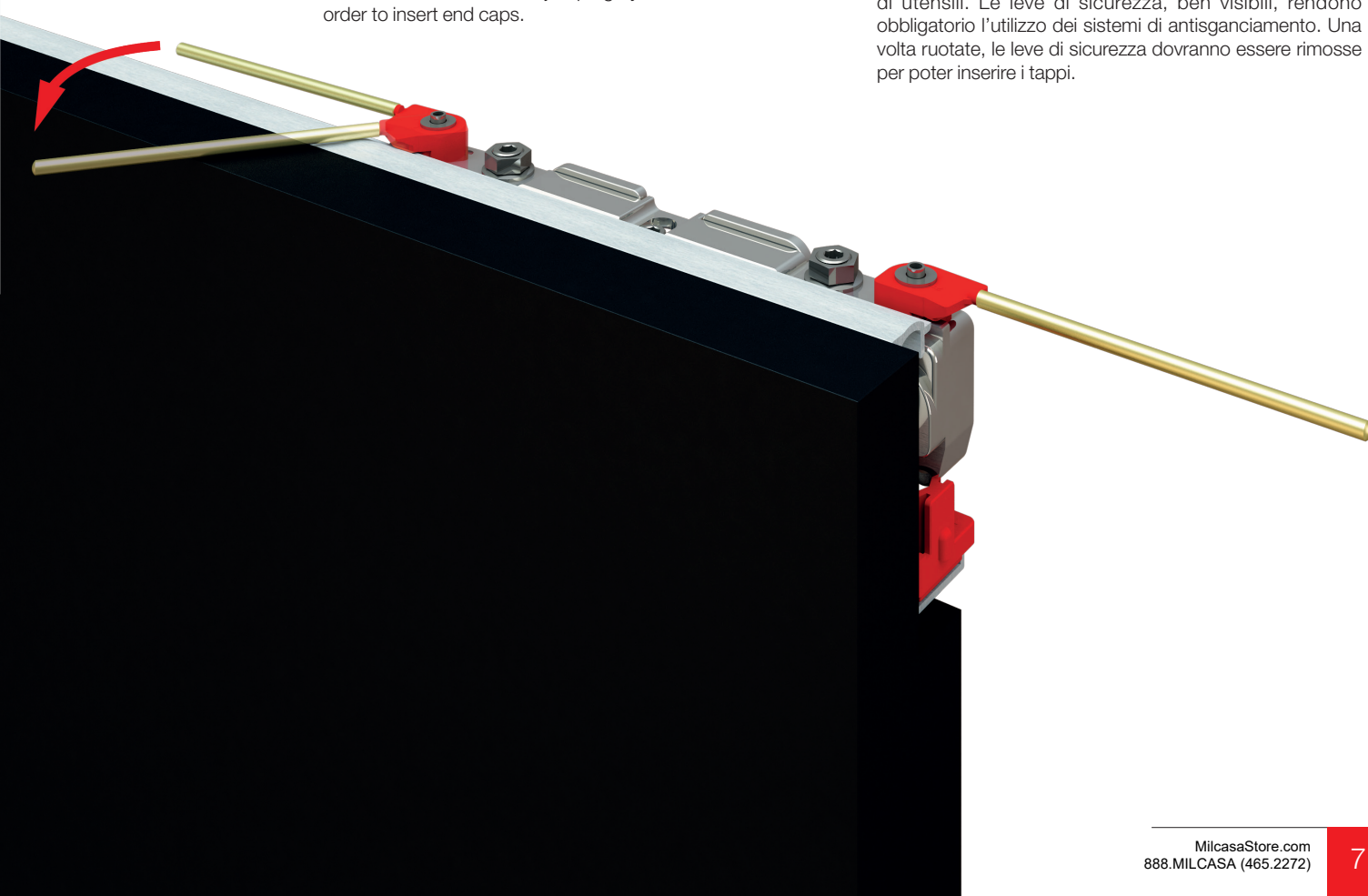

Pratico sistema di antisganciamento

Lo scorrevole **Magic²** comprende due nuovi elementi rotanti di antisganciamento. In questi nuovi elementi sono inserite due leve di sicurezza, per ruotarli senza l'utilizzo di utensili. Le leve di sicurezza, ben visibili, rendono obbligatorio l'utilizzo dei sistemi di antisganciamento. Una volta ruotate, le leve di sicurezza dovranno essere rimosse per poter inserire i tappi.



Silent lower guide

With the purpose of furtherly increase sliding quality, **Magic2** system combines a reinforced lower guide in Zamak (reliable and versatile), which slides in a silent plastic profile.

Guida inferiore silenziosa

Per migliorare ancor di più lo scorrimento, il sistema **Magic2** integra una guida inferiore rinforzata in zama (resistente e versatile), che scorre in un profilo in plastica molto silenzioso.

New patented bottom wheels designed for a better sliding

New **Magic2** bottom wheels are equipped with a **PATENTED** suspension spring system and were designed with a larger diameter, bigger bearing and steel pivots. Rubber surface have been enlarged as well, in order to reinforce wheels and improve sliding quality.

An additional important **PATENTED** innovation in lower sliding system is the introduction of two padded fixed springs which can grant damping function during door motion up to 40kg. Over 40kg of door weight and up to 80kg of maximum load capacity, new bottom wheels will be more flexible than previous version, with their Zamak surface to lean on a rubber internal cylinder, which act as a small shock absorber, granting more stability during sliding motion.

The **Magic2** wheels rubber have high performance:

- it does not leave any trace or sign on sliding surface like floors and walls
- it does not deform over time

Ruote inferiori brevettate per una migliore scorrevolezza

Le nuove ruote inferiori del sistema **Magic2** hanno molleggio **BREVETTATO**, e sono state progettate con diametro, cuscinetti e perni in acciaio maggiorati. Anche il rivestimento in gomma è stato raddoppiato per aumentare la forza e la scorrevolezza delle ruote.

Un'altra importante innovazione **BREVETTATA** nel sistema di scorrimento inferiore è l'inserimento di due molle fisse maggiorate che permettono di ammortizzare il movimento della porta fino ad una portata di 40 kg. Oltre i 40 kg, e fino ad un massimo di 80 kg, queste nuove ruote flettono maggiormente e la superficie realizzata in zama si appoggia su di un cilindro di gomma interno che funge da ammortizzatore supplementare garantendo maggior stabilità.

La gomma delle ruote di **Magic2** è altamente performante:

- non lascia traccia sulle superfici di scorrimento come pavimenti e pareti
- non si deforma nel tempo

KG 0 < KG 40

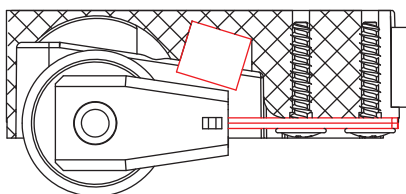

KG 40 < KG 80

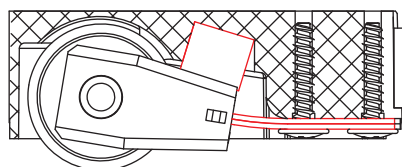

Built-in sliding track with not-through milling

Upper sliding track can be installed "built-in" into a blind milling. Laterally, track's end caps won't be visible, improving even more the aesthetics of door. Door installation and adjustment are not going to be different than usual, because available on the top of the door.

Binario incassato in fresata non passante

Il binario superiore può essere incassato in una fresata cieca. Lateralmente non saranno visibili i tappi del binario, migliorando ulteriormente l'estetica della porta. L'installazione e regolazione della porta non variano perché le regolazioni si effettuano dal lato superiore della porta.

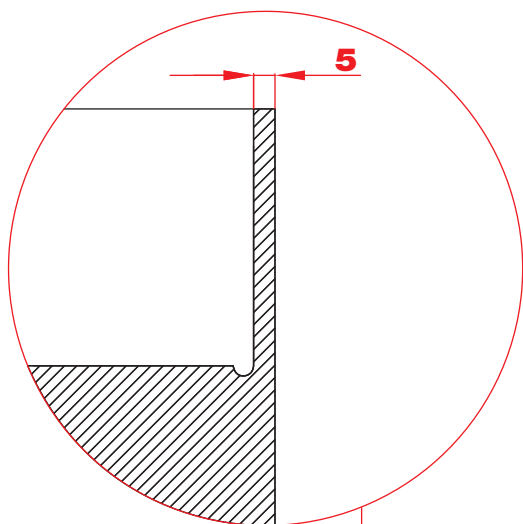

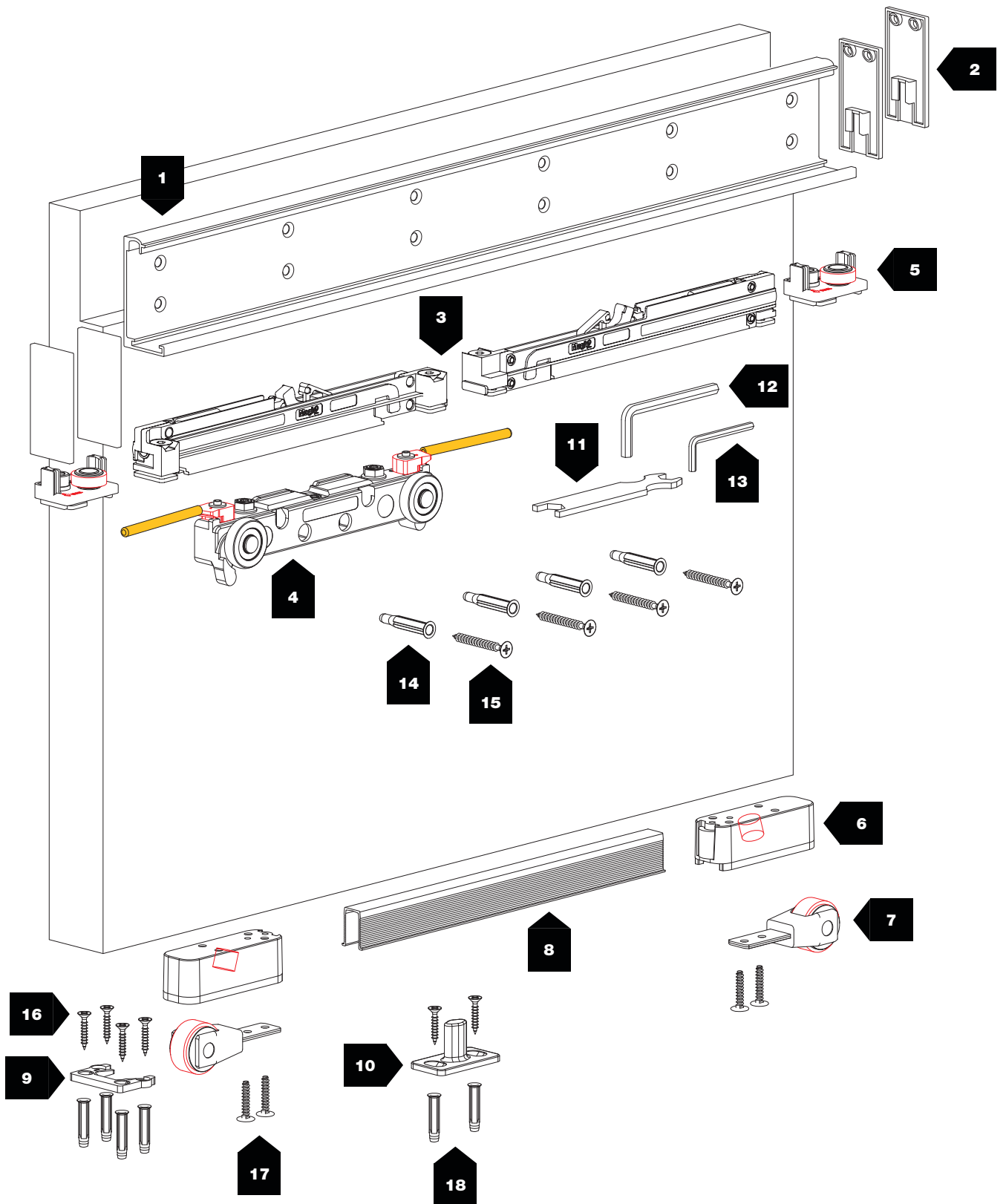











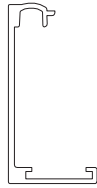
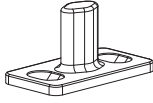
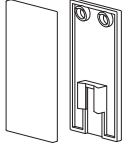

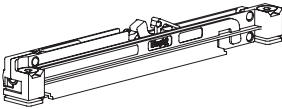

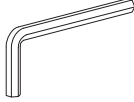
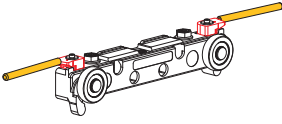

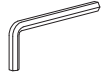
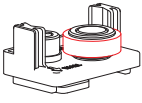
680 ÷ 1800 mm

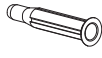
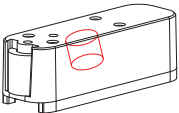

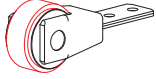
80 kg

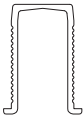

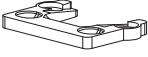
10 mm

N°			kg		N°			kg	
1	2850		—		10	2855		—	
2	2851/N		—		11	1025		—	
	2851/A								
3	2864-80		80		12	538		—	
4	2852		80		13	654		—	
5	2856		—		14	FISCHER UX6		—	
6	2858		80		15	4,5x40		—	
7	2857		80		16	4x30		—	
8	121		—		17	4x20		—	
9	2859		—		18	FISCHER SX5		—	



80 kg



N.2 Soft damper stoppers
N.2 Fermi ammortizzati



Customizable door width
Larghezza porta personalizzabile



Patented system
Sistema brevettato



Standard Finish
Finitura Standard

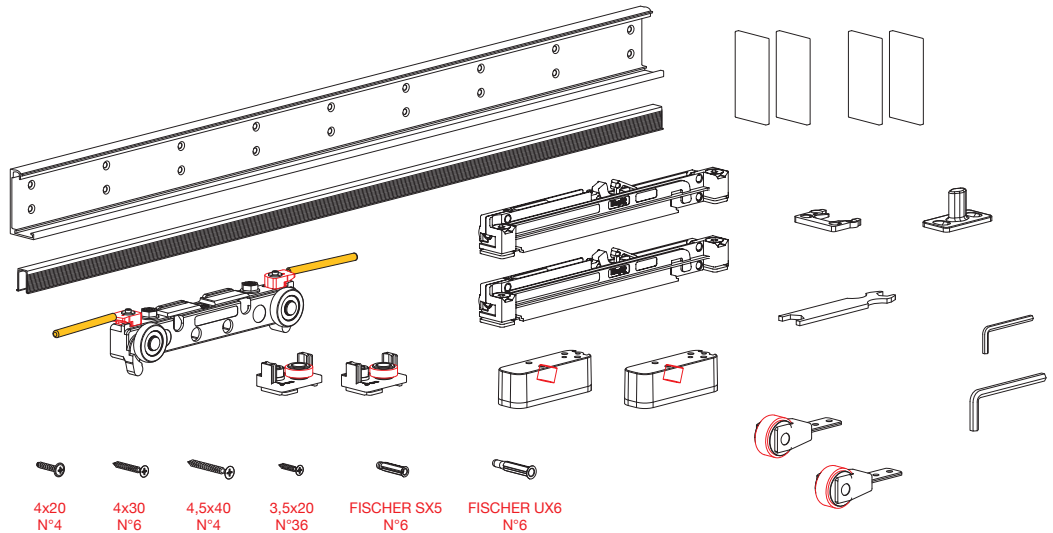

4x20
N°4

4x30
N°6

4,5x40
N°4

3,5x20
N°36

FISCHER SX5
N°6

FISCHER UX6
N°6

OLD CODE	NEW CODE	MIN	
MAGIC2/1100	K.0031.1.01	1100 mm	6x *
MAGIC2/1800	K.0031.2.01	1800 mm	4x

* For export - Min. 12x

MEASUREMENTS DESCRIPTION / DESCRIZIONE MISURE

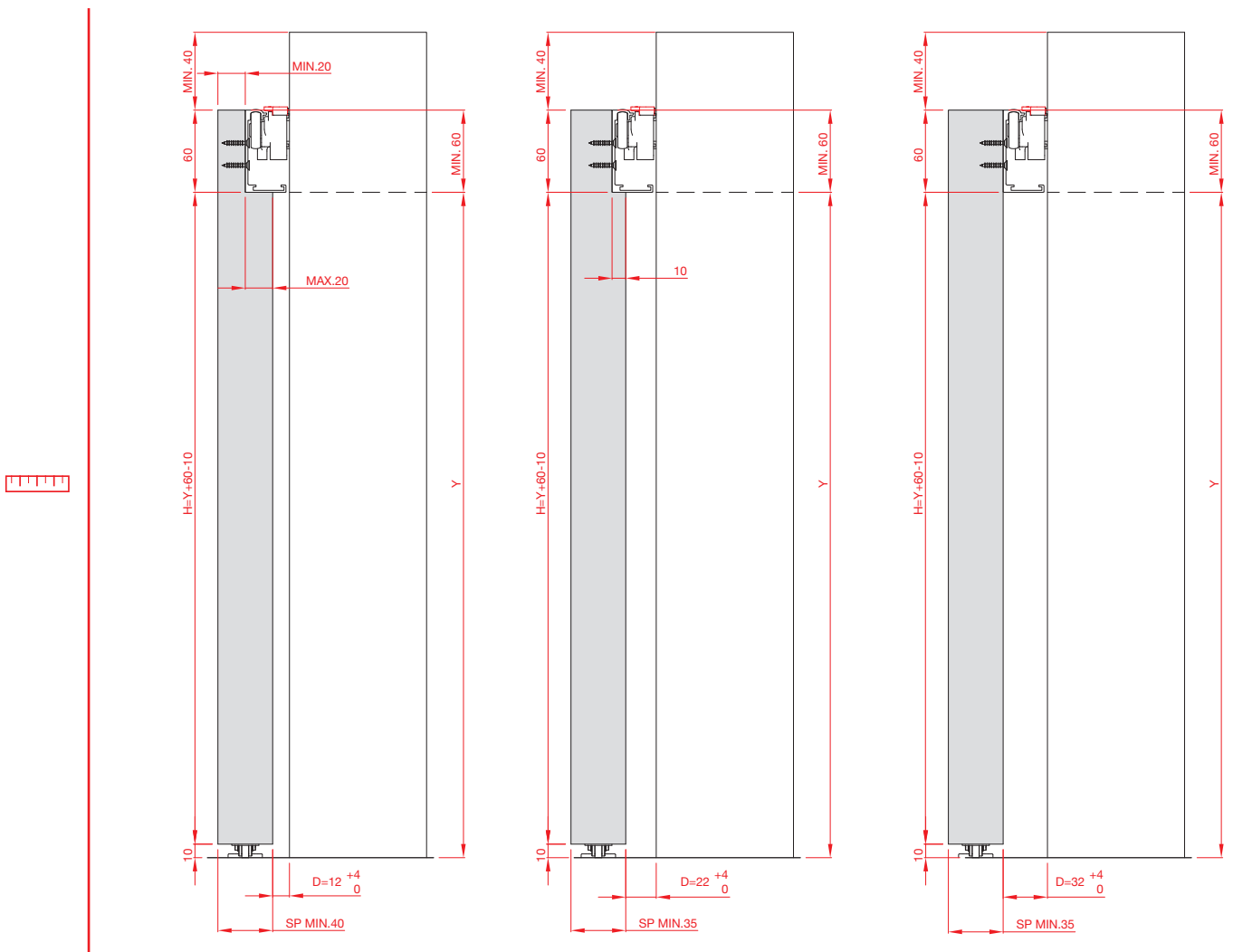

MILLING DESCRIPTION / DESCRIZIONE DELLE LAVORAZIONI

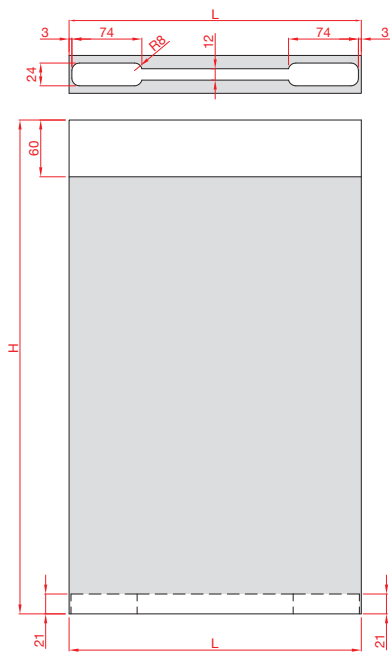

A

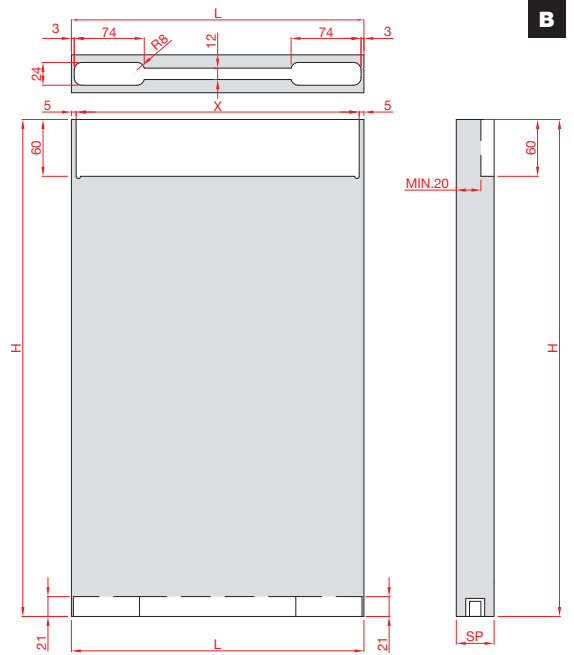

B

HIDDEN MILLED / FRESATA CIECA

PROFILES CUTTING MEASUREMENTS / MISURE DI TAGLIO DEI PROFILI

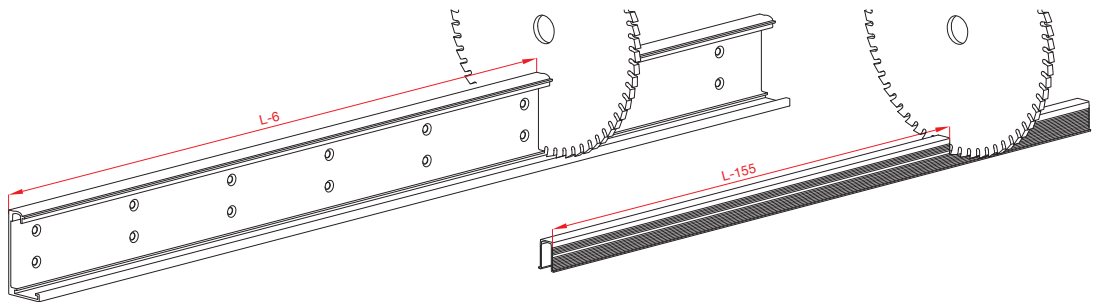

A = L-6
B = L-16

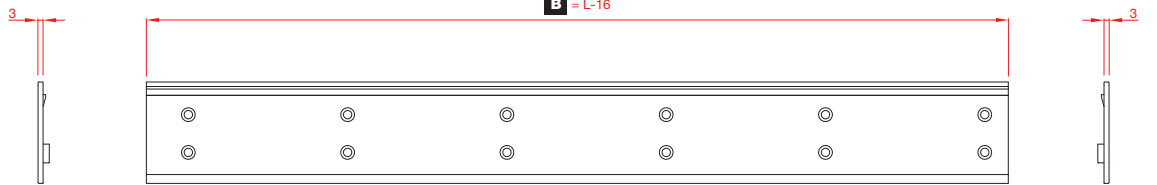

ART. 2851

ART. 2850

ART. 2851

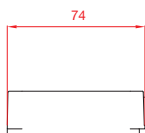

ART. 2858

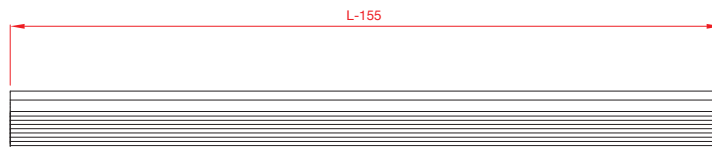

ART. 121

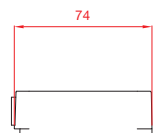

ART. 2858

ACCESSORIES PLACEMENT (STANDARD POSITION) / POSIZIONAMENTO DEGLI ACCESSORI (POSIZIONE STANDARD)

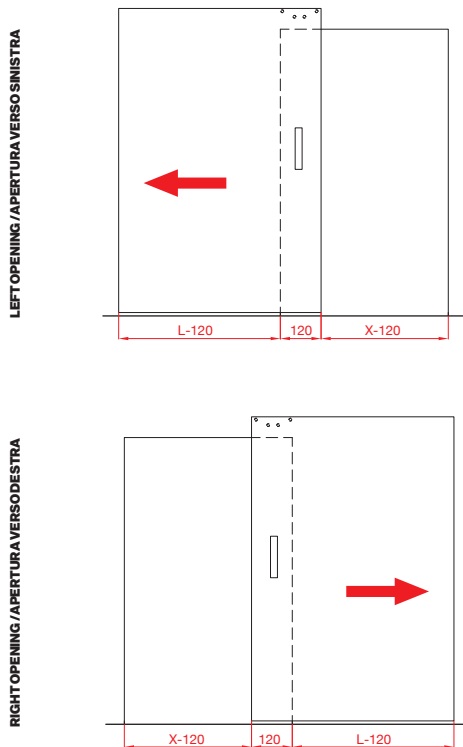

B=0mm (Min.)
B=50mm (Suggested/Suggerito)

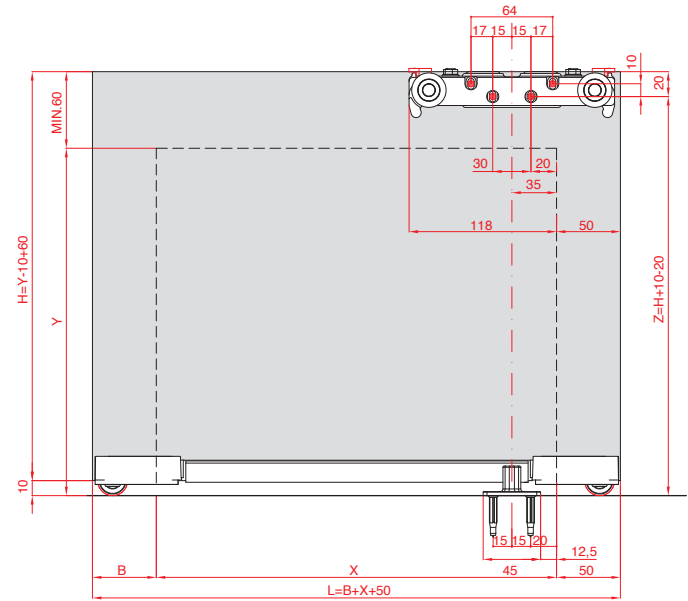

MAGIC2/1100 (K.0031.1.01)

B=0
X= MIN. 800 (L=850)
X= MAX. 1050 (L=1100)

B=50
X= MIN. 800 (L=900)
X= MAX. 1000 (L=1100)

MAGIC2/1800 (K.0031.2.01)

B=0
X= MIN. 800 (L=850)
X= MAX. 1750 (L=1800)

B=50
X= MIN. 800 (L=900)
X= MAX. 1700 (L=1800)

ACCESSORIES PLACEMENT (INTERMEDIATE POSITION) / POSIZIONAMENTO DEGLI ACCESSORI (POSIZIONE INTERMEDIA)

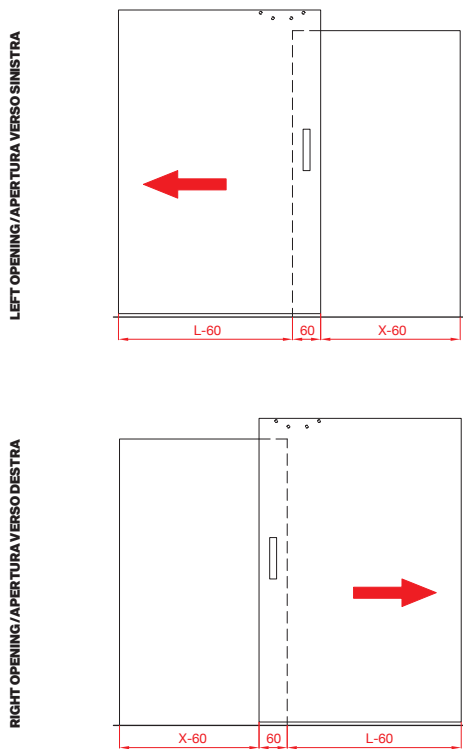

B=0mm (Min.)
B=50mm (Suggested/Suggerito)

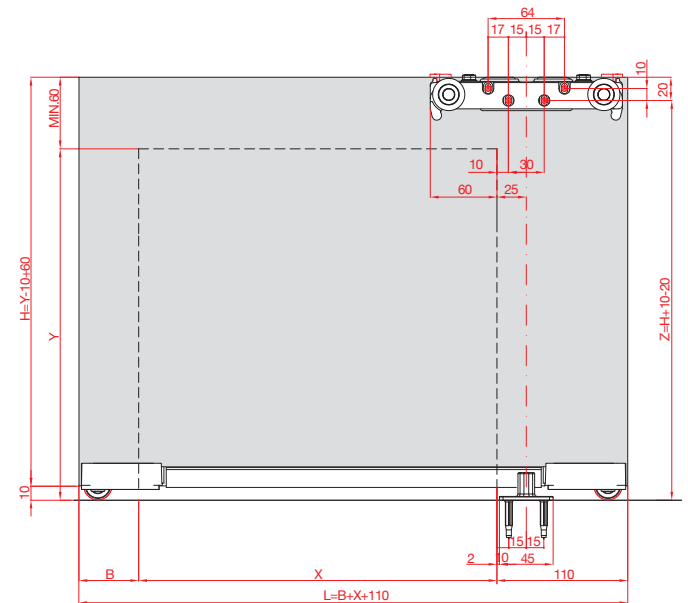

MAGIC2/1100 (K.0031.1.01)

B=0
X= MIN. 740 (L=850)
X= MAX. 990 (L=1100)

B=50
X= MIN. 740 (L=900)
X= MAX. 940 (L=1100)

MAGIC2/1800 (K.0031.2.01)

B=0
X= MIN. 740 (L=850)
X= MAX. 1690 (L=1800)

B=50
X= MIN. 740 (L=900)
X= MAX. 1640 (L=1800)

ACCESSORIES PLACEMENT (TOTAL OPENING POSITION) / POSIZIONAMENTO DEGLI ACCESSORI (POSIZIONE APERTURA TOTALE)

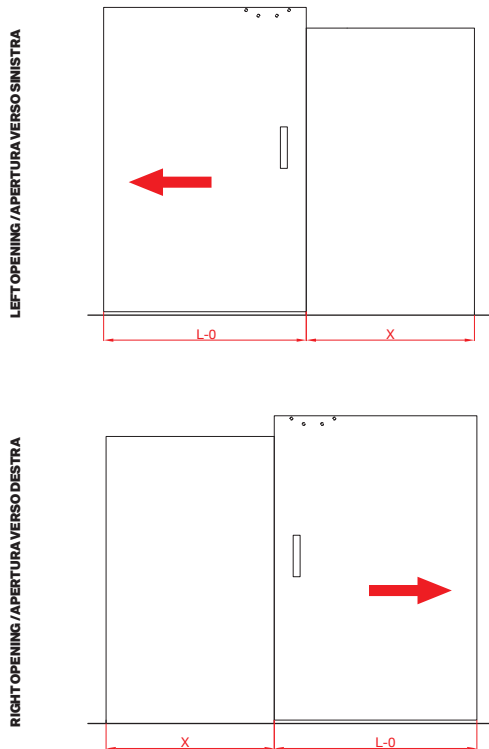

B=0mm (Min.)
B=50mm (Suggested/Suggerito)

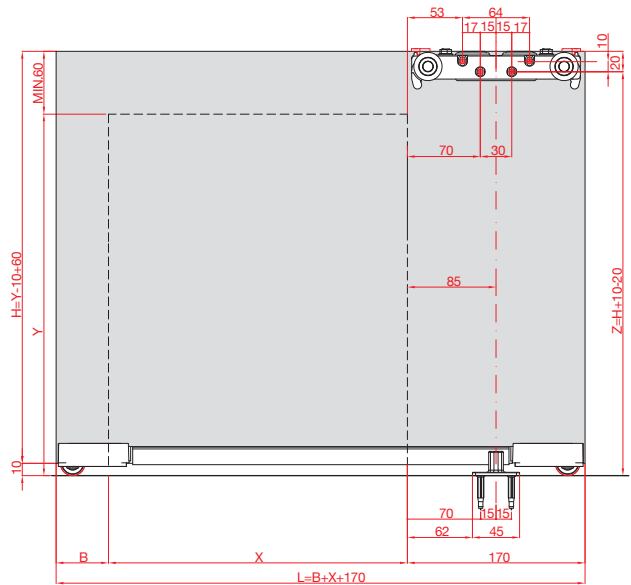

MAGIC2/1100 (K.0031.1.01)

B=0
X= MIN. 680 (L=850)
X= MAX. 930 (L=1100)

B=50
X= MIN. 680 (L=900)
X= MAX. 880 (L=1100)

MAGIC2/1800 (K.0031.2.01)

B=0
X= MIN. 680 (L=850)
X= MAX. 1630 (L=1800)

B=50
X= MIN. 680 (L=900)
X= MAX. 1580 (L=1800)

ART. 2859 - END STOPPER / FINE CORSA

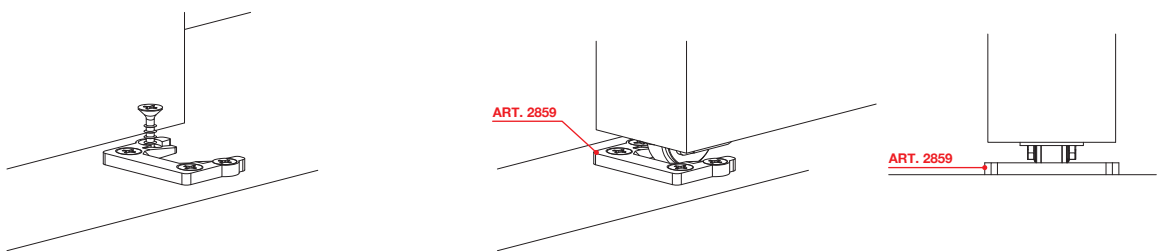

**ALUMINIUM TRACK FOR IRREGULAR FLOOR
PROFILO IN ALLUMINIO PER PAVIMENTAZIONE IRREGOLARE**

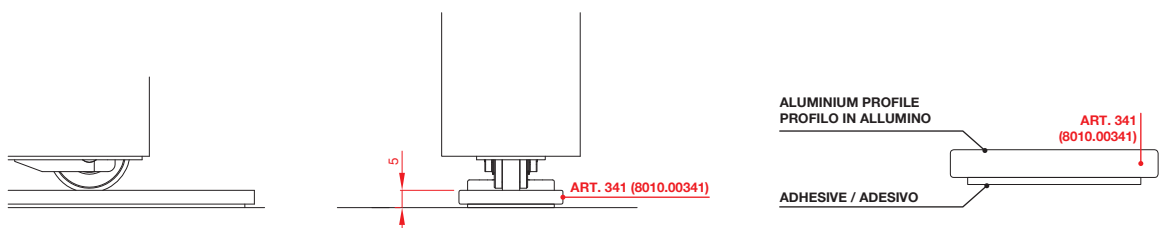

ART. 341
8 01 0 .00341



MILCASA STORE

support@milcasastore.com
MILCASASTORE.COM

888.MILCASA (465.2272)