

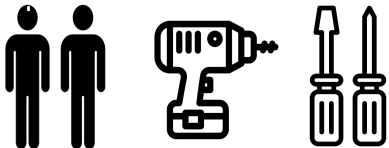





# Installation & Assembly





Carton L



					
Base ① 1PC	Backrest ② 1PC	11CM Leg ③ 2PCS	5CM Leg ④ 4PCS	M6 Screw ⑤ 8PCS	M5 Screws ⑥ 8PCS



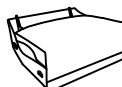





Carton M



		
Base ① 1PC	Backrest ② 1PC	11CM Leg ③ 4PCS

Carton R



							
Base ① 1PC	Backrest ② 1PC	11CM Leg ③ 2PCS	5CM Leg ④ 4PCS	M6 Screw ⑤ 8PCS	M5 Screws ⑥ 8PCS	Adapter cable ⑦ 1PCS	Power cord ⑦ 1PCS

Install the left position first:  
Use #4 (screws) to install #1 (sofa legs) to the corresponding position on the sofa base.

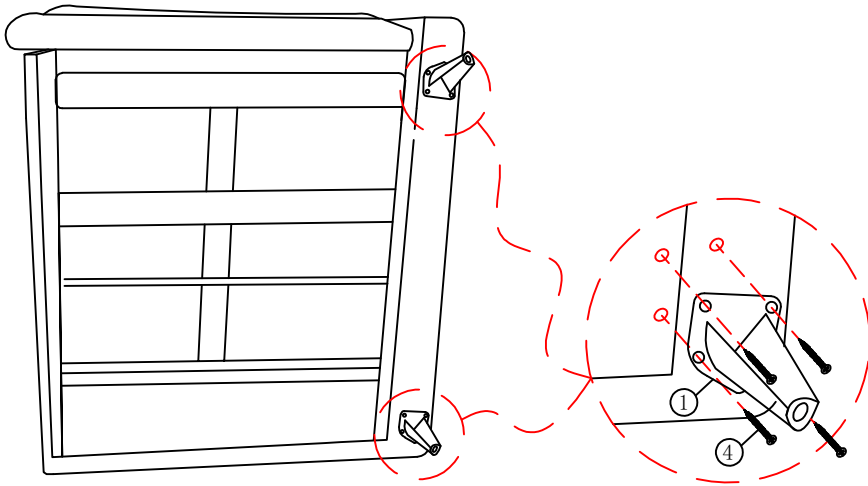

1

Use #3 (screws) to install #2 (sofa legs) to the corresponding position on the sofa base.

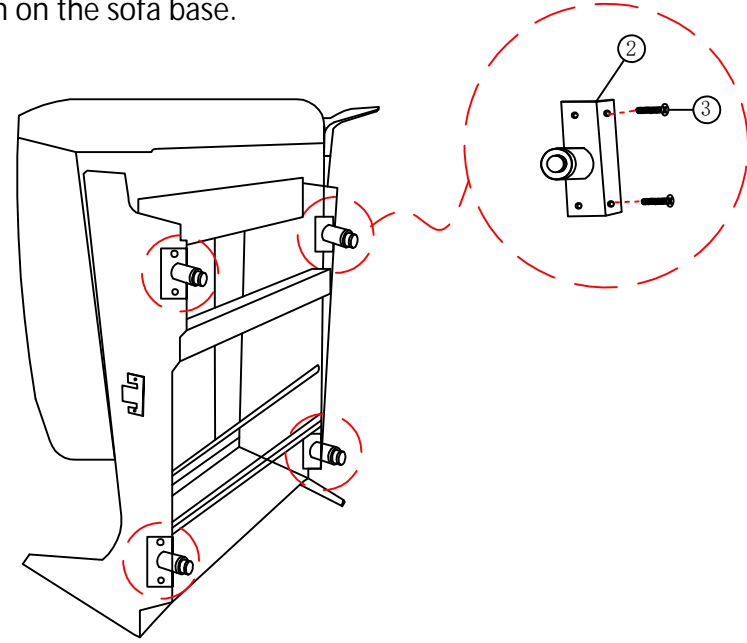

2

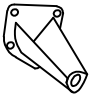

① 2 pcs

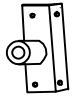

② 4 pcs



③ 8 pcs



④ 8 pcs

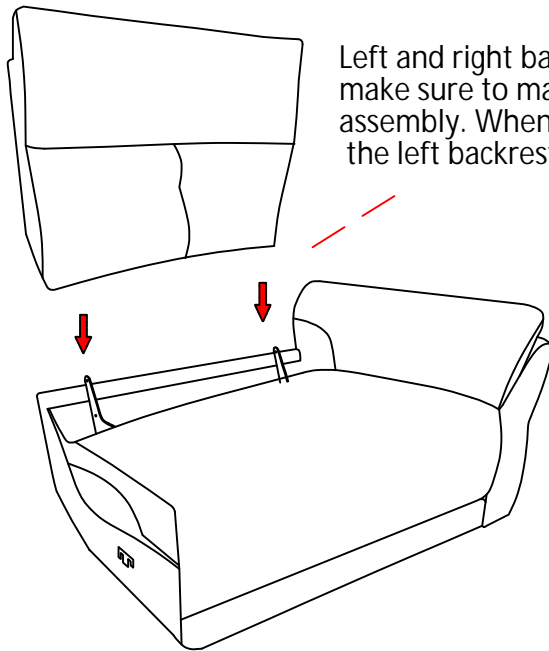

Left and right backrests are different —  
make sure to match them correctly during  
assembly. When installing the left side, use  
the left backrest.

3

Attach the left backrest to the corresponding position.

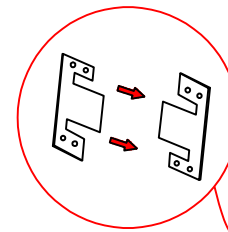

4

This catch is used to connect the two sofa seats.

Install the right position first:  
Use #4 (screws) to install #1 (sofa legs) to the corresponding position on the sofa base.

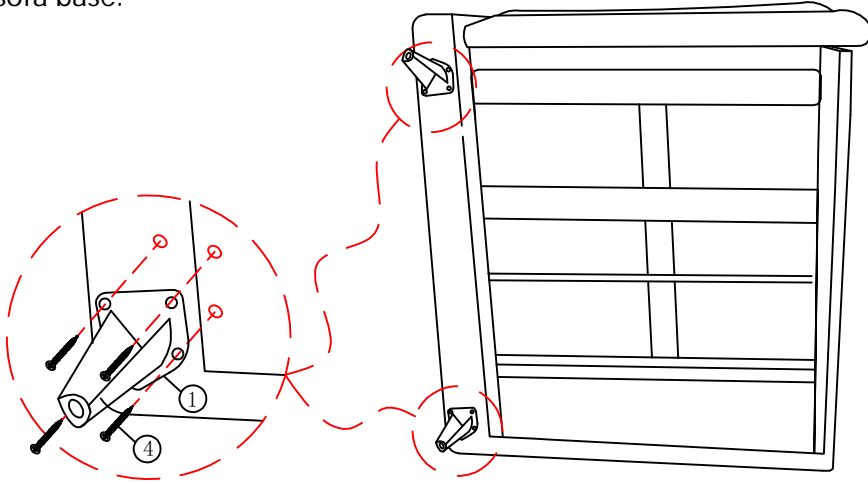

1

Use #3 (screws) to install #2 (sofa legs) to the corresponding position on the sofa base.

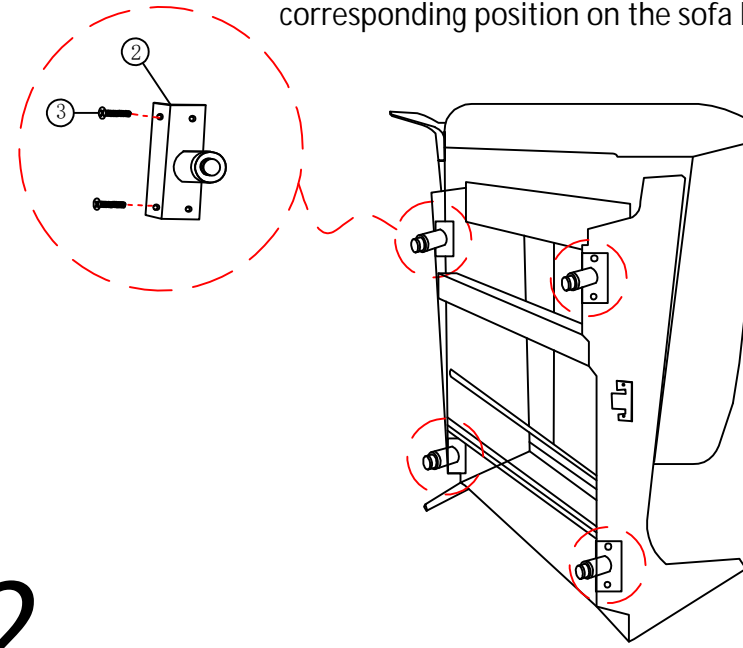

2

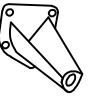

① 2 pcs

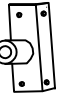

② 4 pcs



③ 8 pcs



④ 8 pcs

Left and right backrests are different  
— make sure to match them correctly  
during assembly. When installing the  
right side, use the right backrest.

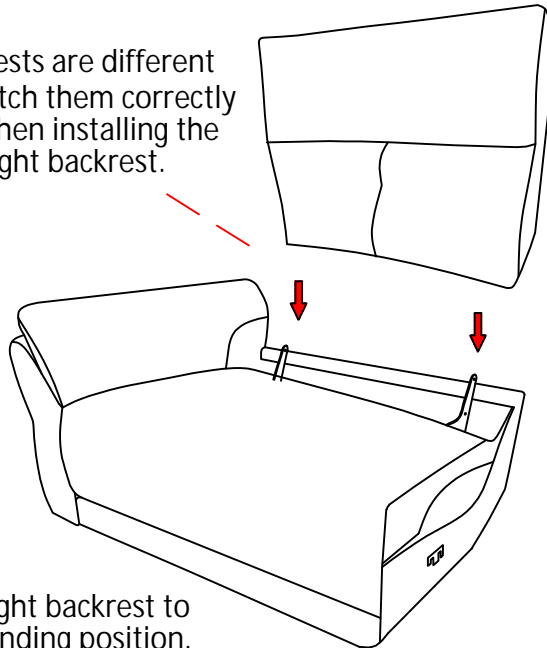

3

Attach the right backrest to  
the corresponding position.

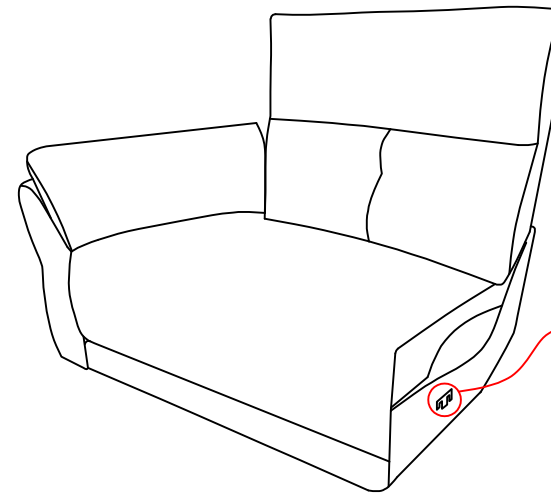

4

This catch is used to connect the two sofa seats.



⑤ 1 pcs

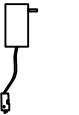

⑥ 1 pcs

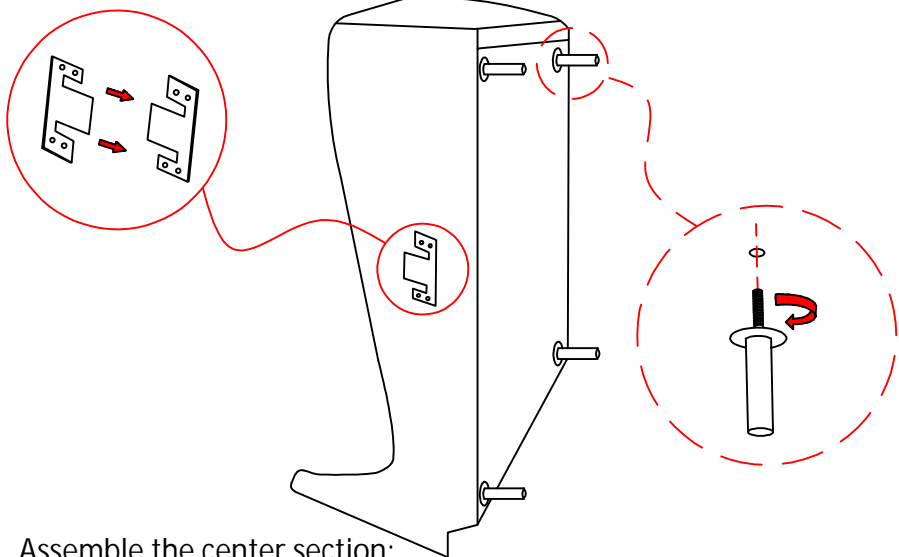

**1** Assemble the center section:  
Attach #7 (sofa foot) to the corresponding position on the bottom of the center sofa unit.

Attach the center backrest to the corresponding position.

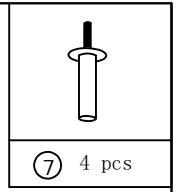
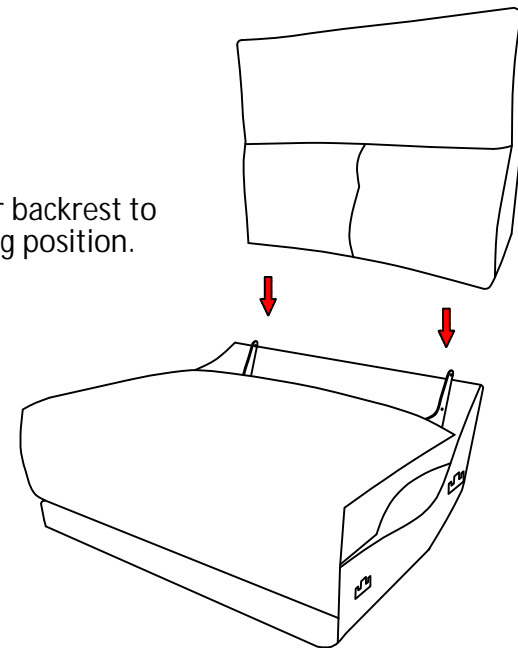

**2**

This power cord for a 3-seater sofa has one main plug that splits into two connectors (or ends), which plug into the power sockets on the left and right seats.

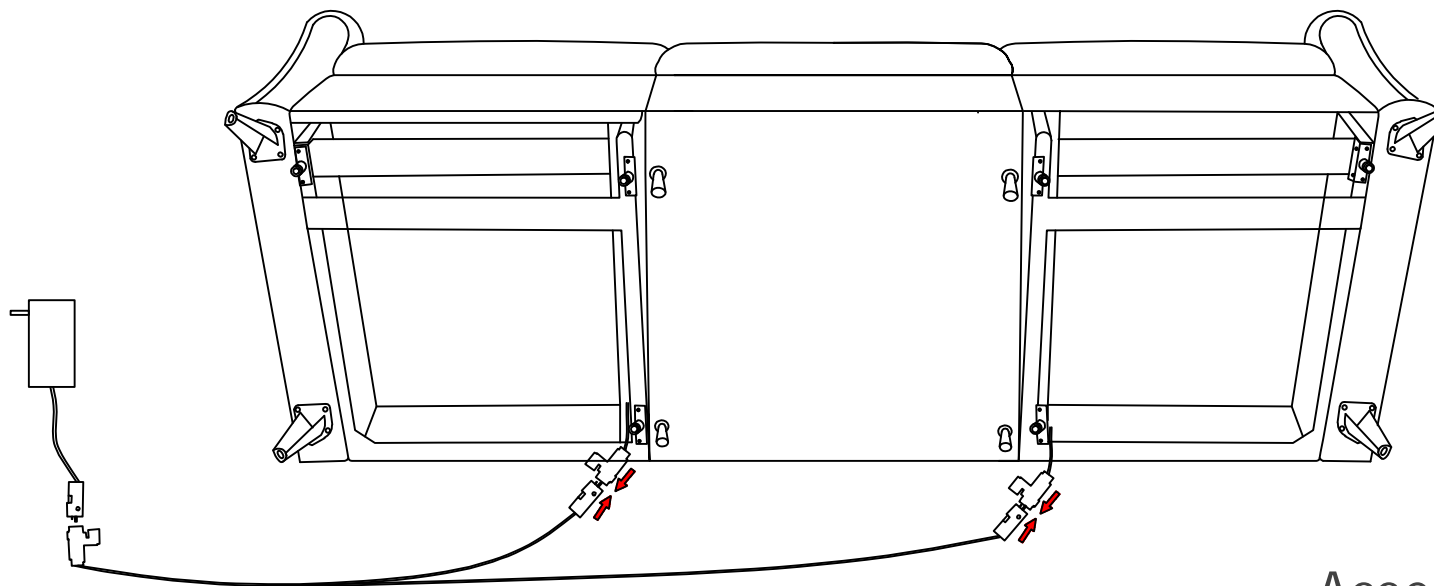

**3**

Assembly complete!