

# Assembly Instructions

**Caution : You must read this before you proceed**

**Please look in the Table top for hardware packs.**

## **TABLE**





**CAUTION:** This Table is NOT a TOY.



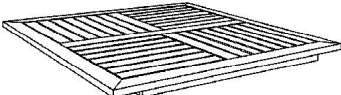

Keep your child / children at bay during the assembly process.

For moving the Table and to prevent damage to the Table, two adults are needed to execute this action.

# Parts List

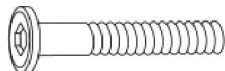
| Label | Picture   | Description | QTY |
|-------|---|-------------|-----|
| A     |  | Table Top   | 1   |
| B     |  | Leg         | 4   |
| C     |  | Leg Support | 4   |

# Hardware

| Label | Picture  | Description     | QTY |
|-------|--|-----------------|-----|
| ①     |   | Bolt (M6x50mm)  | 9   |
| ②     |   | Screw (M6x35mm) | 9   |
| ③     |   | Washer          | 9   |
| ④     |  | Allen Key       | 1   |

# Assembly Preparation

Before Beginning Assembly:

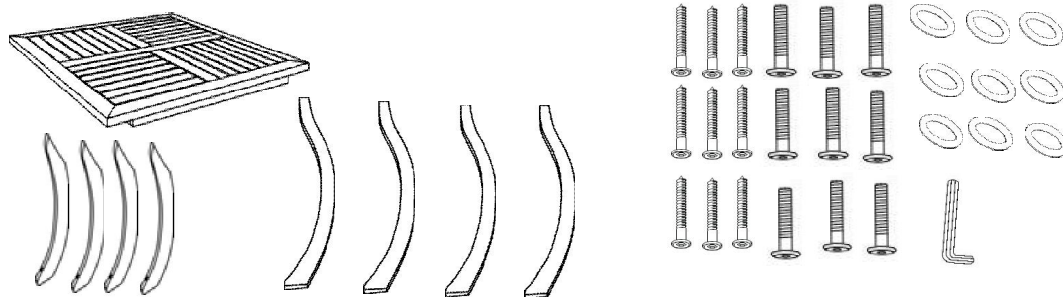

- Read instructions, cover to cover-



- Have 2 adults on hand for assembly-



- Do not assemble on flooring or carpet-



- Assemble on a clean non-marring surface (packing foam)-



- Save all packaging until finished-

# Assembly Steps

## OVERVIEW

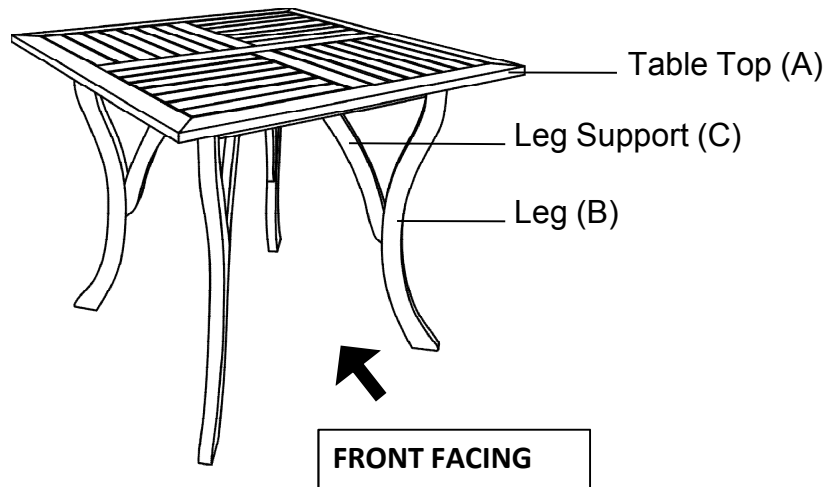

This Table has multiple parts and may require up to some 30 minutes to assemble. To give you an overview of the Table parts, the above picture is to help you put the various parts into perspective. Please read through the instructions below to familiarise yourself with the parts and steps before assembly.

## Step 1

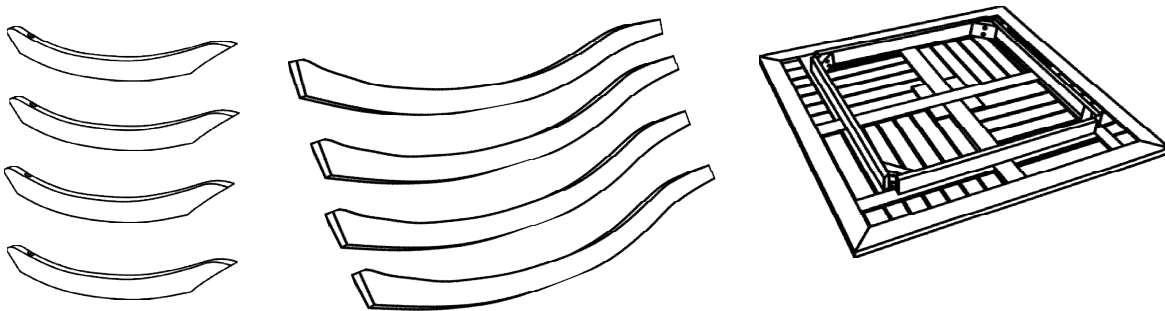

Unpack and place all parts on a clean, non-marring surface.

## Step 2

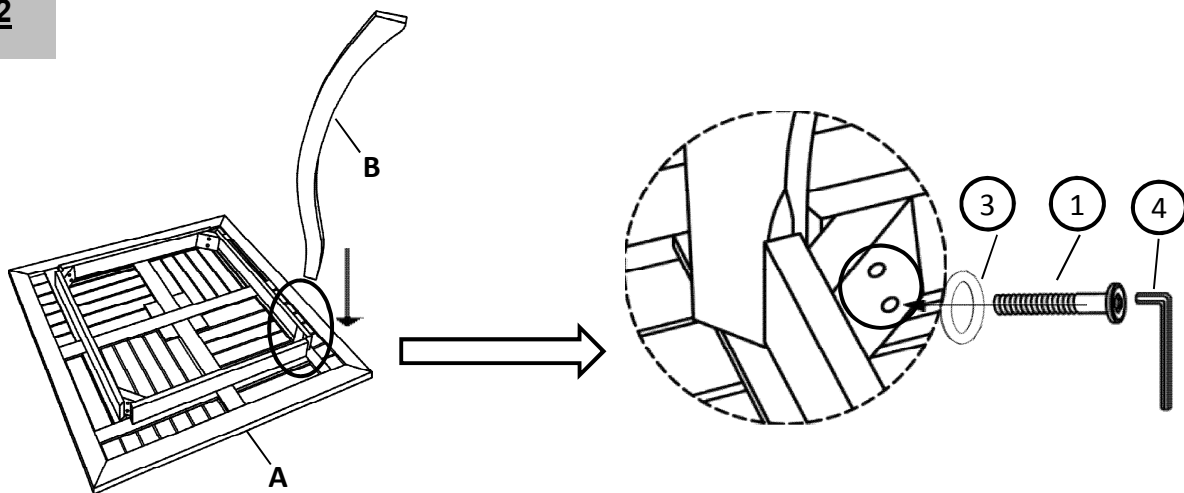

Attach Leg(B) to the Table Top(A) using Bolt (①) and Washer(③) with Allen Key(④).

**Only loosely tighten the Bolts.**

Repeat the same process with the remaining three Legs(B)

# Assembly Steps

## Step 3

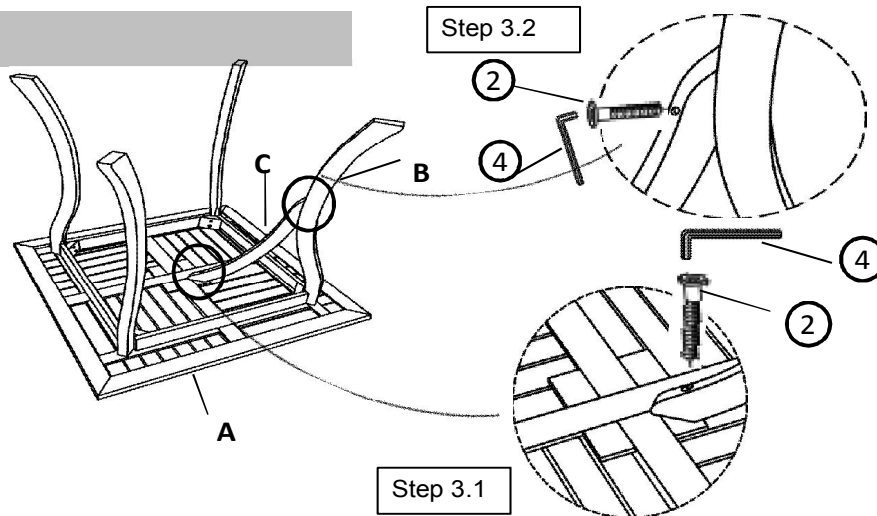

Place Leg Support(C) between Table Top(A) and Leg(B), as shown above  
**3.1)** Secure Leg Support(C) to Table Top(A) using Screw (②) with Allen Key(④)  
**3.2)** Secure Leg Support(C) to Leg(B) using Screw(②) with Allen Key(④)  
**Only loosely tighten the Screws.**  
Repeat the same process with the remaining three Leg Supports(C).

## Step 4

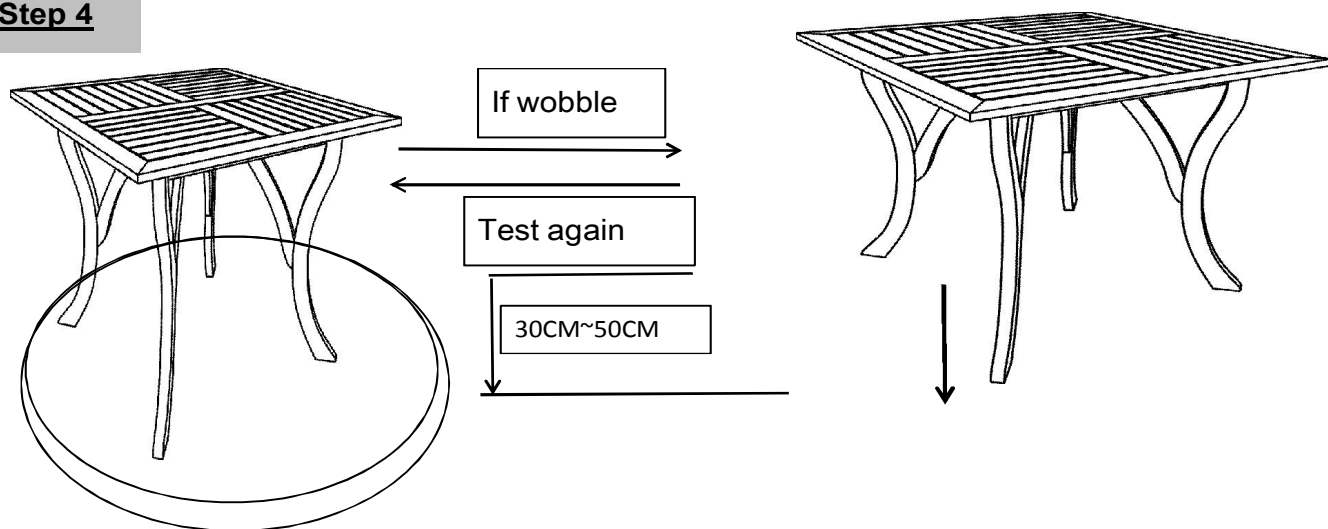

Place the Table right side up on a **LEVEL SURFACE** to see if it wobbles.  
If it wobbles, lift the Table to some 30cm to 50cm height from the ground.  
Keep your feet and toes well away from the drop zone.

Drop the Table freely and vertically with the four legs, hitting the ground, at the same time.  
This Drop Test will help to ensure that all the Bolts, Screws and gaps all reach full alignment status.  
Test again for evenness on a **LEVEL SURFACE**.  
If no wobbles are found, proceed to tighten all the Screws, and Bolts.

**CAUTION: When tightening the Screws, and Bolts tighten sequentially. DO NOT tighten any Bolt, or Screw fully and then move towards the next one. This could cause the frame to warp.**  
If there are still wobbles, loosen the Screws and Bolts and execute this same drop tests.  
**If the Table is not stable, it could lead to damage to the product.**

# Assembly Steps









## Step 5



Inspect Table and make sure all parts are adequately connected.  
Your Table is ready for use.

**This Table can only be used on a flat, level surface.**

## Care & Maintenance

-  ● Do not put hot items directly on furniture surface
  -  ● Do not clean furniture with harsh cleansers or polish.
  -  ● To obtain the longest lifespan of your outdoor products, minimizing exposure to direct sunlight is recommended.
  -  ● Children should not climb or jump on the furniture.
  -  ● Do not write on furniture without a padded barrier to protect the surface.
  -  ● To obtain the longest lifespan of your outdoor products, avoid extended and lengthy exposure to rain, snow, and direct sunshine. Whenever possible cover the product and /or place under patio or awnings.
  -  ● Not for commercial use. For residential use only .
  -  ● Stains may be removed with mild soap solution and damp cloth.
- 
-  ● Dust and pick-up spills using a clean, non-colored, lint-free cloth .