

# USER'S MANUAL

## DINING TABLE

THIS INSTRUCTION BOOKLET CONTAINS **IMPORTANT** SAFETY INFORMATION. PLEASE READ AND KEEP FOR FUTURE REFERENCE.



## Before You Start

- ⚠ Read each step carefully before starting. It is very important to ensure each step followed in correct order, otherwise assembly difficulties may occur.
- ⚠ Most of board parts are labeled or stamped on the raw edges. Have a check to make sure all parts are included.
- ⚠ Work in a spacious area, preferably on a carpet close to where the unit will be used.
- ⚠ Keep the handtools close at hand. Do not use power tools to assemble your furniture. They may scratch or damage the parts.

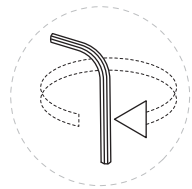
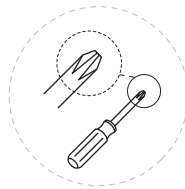
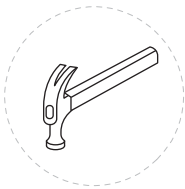
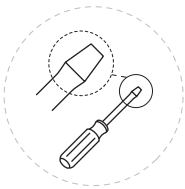

## Part List

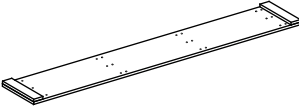

1 x1 pc  
Middle Slat

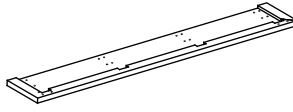

2 x2 pcs  
Side Slat

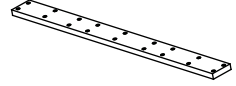

3 x2 pcs  
Connecting Slat

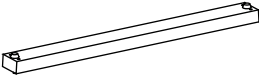

4 x2 pcs  
Base of Table



5 x4 pcs  
Table Leg

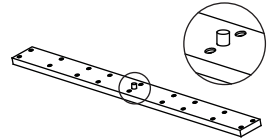

6 x2 pcs  
Connecting Slat with Iron Dowel



M6x25mm Screw  
A x16pcs



M4x20mm Screw  
B x72pcs



M6x45 Bolt  
C x8pcs



M4 Allen Key  
D x2pcs



Parasol Hole Cap  
E x1pc

**STEP 1:**

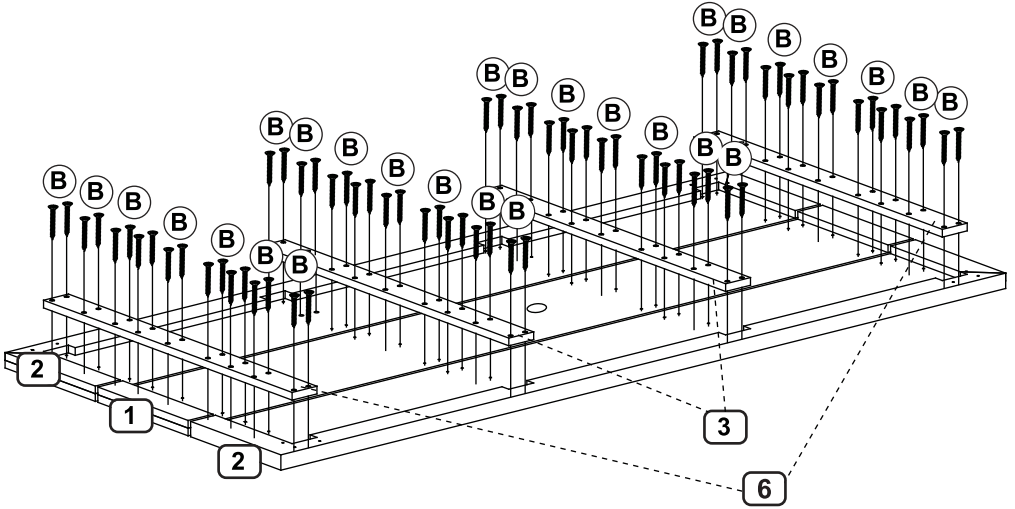
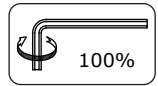

**STEP 2: X2**

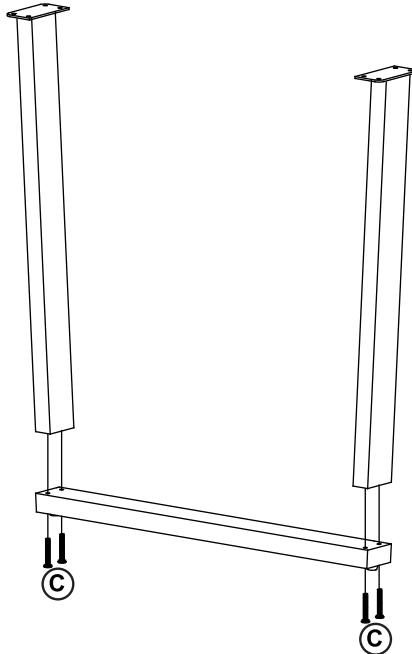
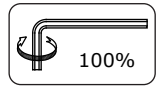

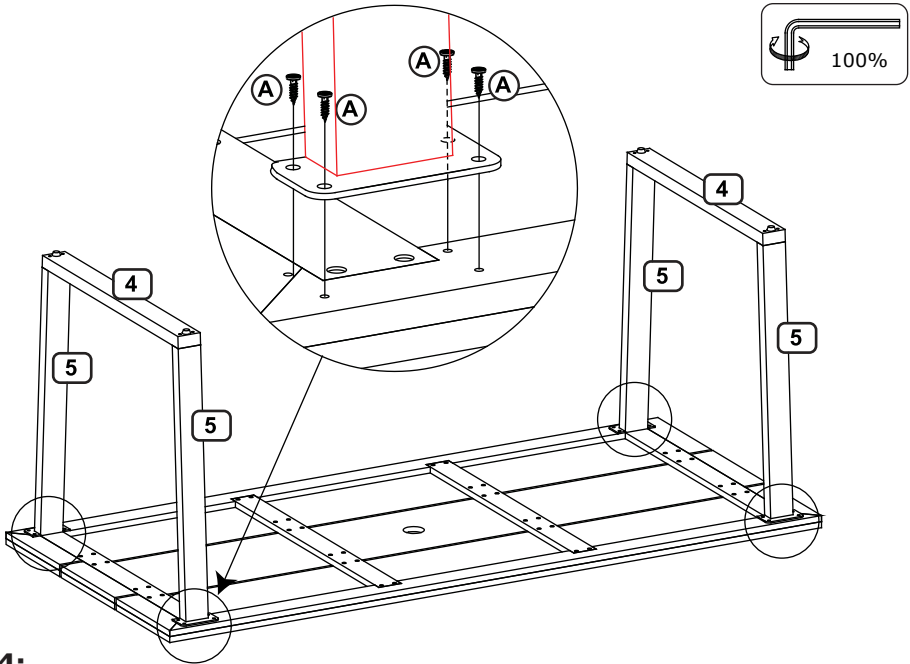
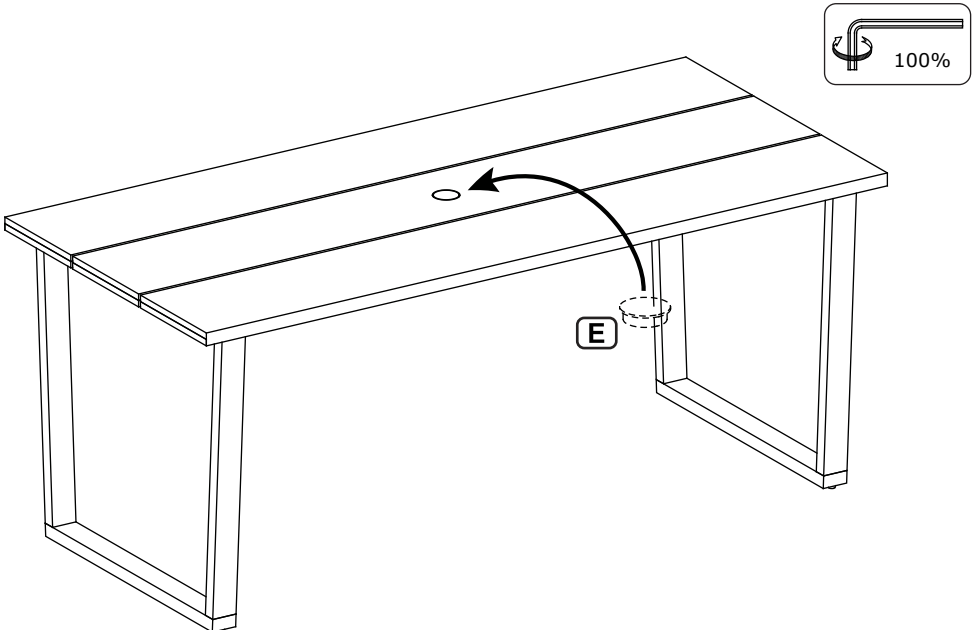
**STEP 3:****STEP 4:**

## **Care and Maintenance**

Use a soft, clean cloth that will not scratch the surface when dusting.

Use of furniture polish is not necessary.

Should you choose to use polish, test first in an inconspicuous area.

Using solvents of any kind on your furniture may damage the finish.

Never use water to clean your furniture as it may cause damage to the finish.

Liquid spills should be removed immediately. Using a soft clean cloth, blot the spill gently. Avoid rubbing.

Check bolts/screws periodically and tighten them if necessary.

## **Further advice about wood furniture care**

Please protect your outdoor furniture with a cover when not in use since

Long-term sunlight exposure will result in the damage on the surface.

In addition to sunlight damage, wood and metal frame suffers when exposed to extremes in temperature and humidity.

Proper care and cleaning at home will extend the life of your purchase.

Following these important and helpful tips will enhance your furniture as it ages.