

Instruction Manual

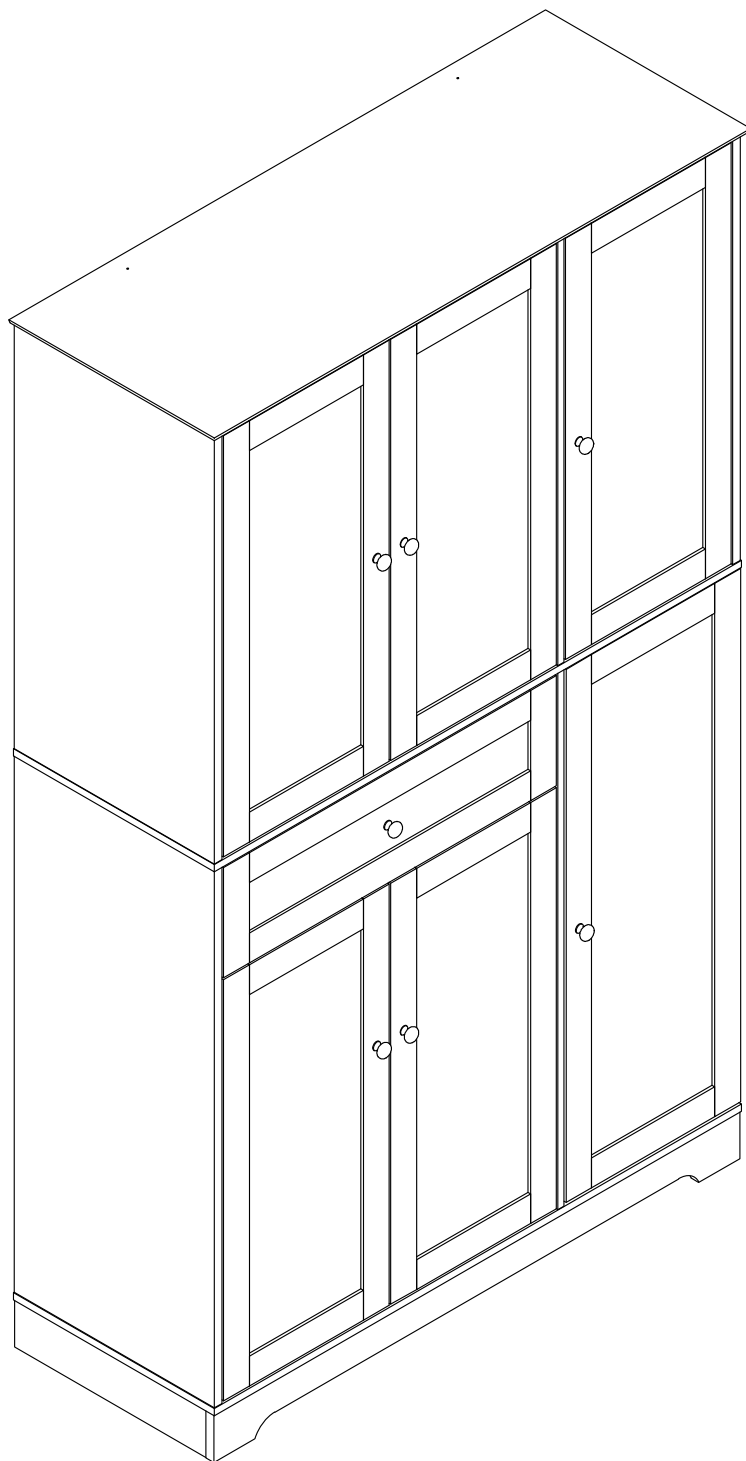

HOS-PB-418

HOS-PB-419

HOS-PB-320

HOS-PB-321

V1.1

Cabinet

EN

Thank you for purchase on our products. Please contact us if you have difficulty with assembly or need replacement parts. Our customer service is here to assist you. Please attach your User Name or Order ID so that we can assist you better.

WARNING

Serious or fatal injury may occur from unexpected assembly or use.

1. During the assembly process, keep all parts away from babies or children.
2. Always securely fix this product to the wall. Make sure the wall area to be drilled is free from hidden electrical wires, water and gas pipes.
3. Use of tip-over restraints may only reduce, but not eliminate the risk of tip-over.
4. Unless specially designed to accommodate, do not set heavy objects on top of this product.
5. Place the heaviest items on the lowest shelf.
6. Never allow children to climb or bang on drawers, doors or shelves.

DE

Vielen Dank für Ihren Kauf von uns Produkten. Bitte kontaktieren Sie uns, wenn Sie Probleme mit Montage haben oder Ersatzteile benötigen. Wir Kundenservice ist für Sie da. Bitte geben Sie Ihren Benutzernamen oder Ihre Bestellnummer an, damit wir Sie besser unterstützen können.

WARNUNG







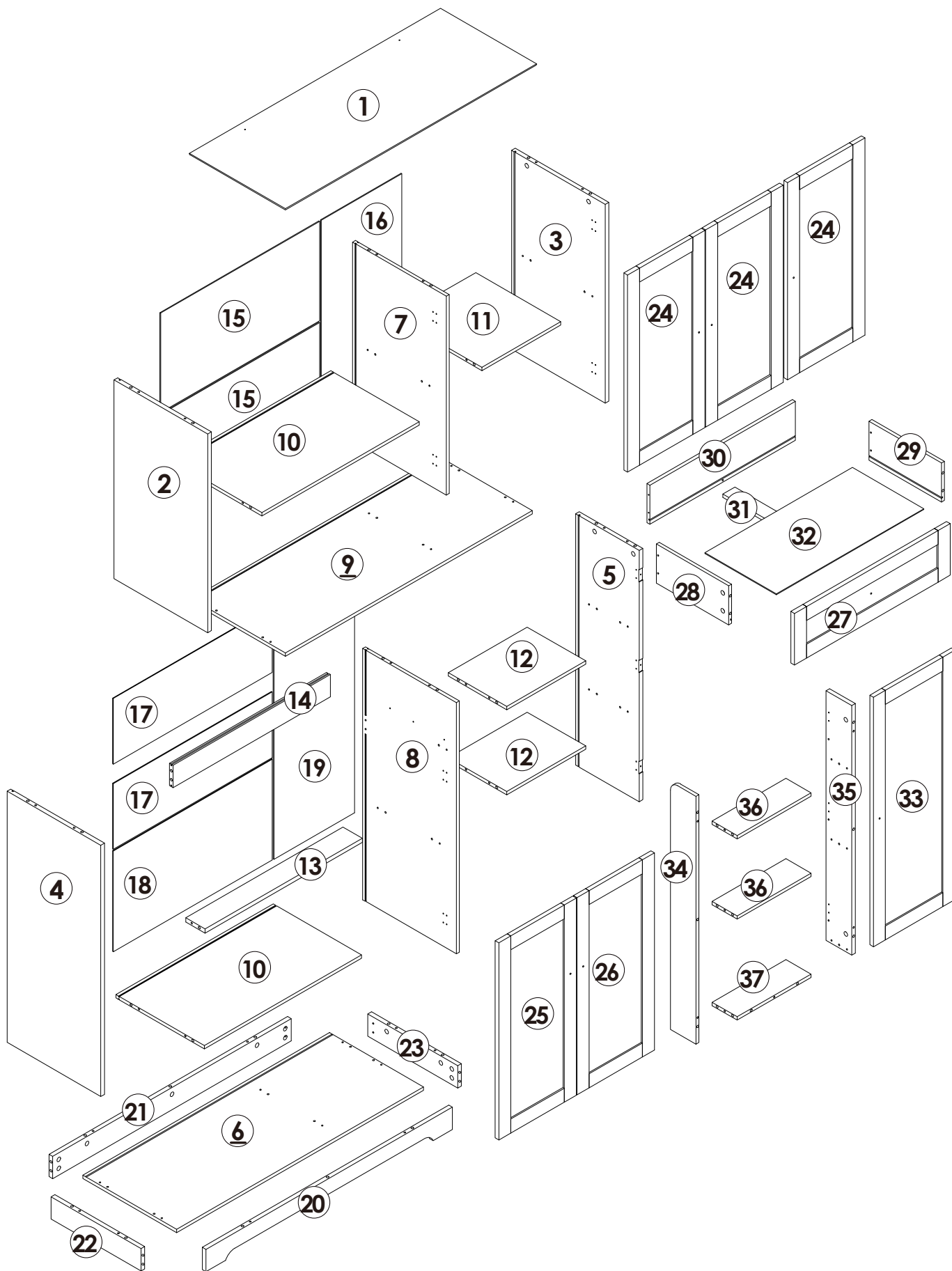



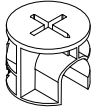

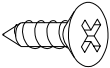
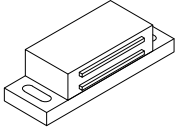
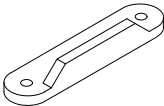
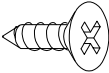

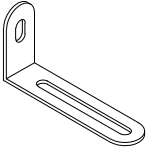
Bei unerwarteter Montage oder Verwendung können schwere oder tödliche Verletzung auftreten.

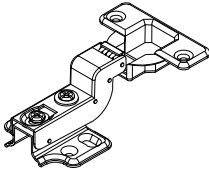
1. Legen Sie in den Montageprozess alle Teile weg von Babys oder Kindern.
2. Stellen Sie sicher, dass der gebohrte Wandbereich frei von verborgenen Stromkabeln, Wasser- und Gasleitungen ist, wenn Sie dieses Produkt an der Wand befestigen.
3. Die Verwendung von Kippsicherungen kann die Gefahr eines Kippens nur verringern, jedoch nicht beseitigen.
4. Setzen Sie bitte keine schweren Gegenstände auf dieses Produkt, es sei denn, dass das Produkt speziell für die Unterbringung konzipiert wird.
5. Legen Sie bitte die schwersten Gegenstände auf das unterste Regal.
6. Erlauben Sie nie Kindern, auf Schubladen, Türen oder Regale zu klettern oder zu knallen.

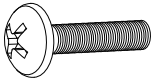
Parts List(EN) / Teile Liste(DE)

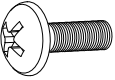
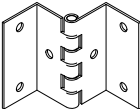
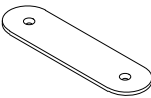
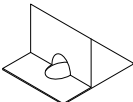
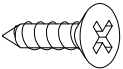

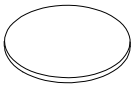
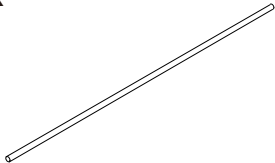

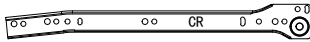
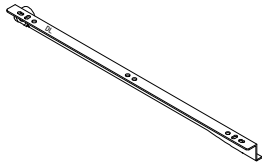
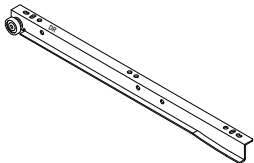
Parts List(EN) / Teile Liste(DE)

<p>A</p>  <p>M6×32mm 81+2PCS</p>	<p>B</p>  <p>Ø15×9.5mm 81+2PCS</p>	<p>C</p>  <p>Ø6×30mm 65+2PCS</p>	<p>D</p>  <p>M3×12mm 2PCS</p>
<p>E</p>  <p>45×16×12mm 1PC</p>	<p>F</p>  <p>52×13×8mm 5PCS</p>	<p>G</p>  <p>M3.5×12mm 100+2PCS</p>	<p>H</p>  <p>M4×40mm 12+1PCS</p>
<p>I</p>  <p>2PCS</p>	<p>J</p>  <p>74×24×15mm 2PCS</p>	<p>K</p>  <p>M4×32mm 2PCS</p>	<p>L</p>  <p>M4×10mm 2PCS</p>
<p>M</p>  <p>Ø35mm 10PCS</p>	<p>N</p>  <p>Ø24×21mm 7PCS</p>	<p>O</p>  <p>M4×18mm 6PCS</p>	<p>P</p>  <p>M4×32mm 5PCS</p>
<p>Q</p>  <p>M4×8mm 1PC</p>	<p>R</p>  <p>3PCS</p>	<p>S</p>  <p>45×12×1mm 1PC</p>	<p>T</p>  <p>12.5×15×9mm 22+2PCS</p>
<p>U</p>  <p>M3×14mm 22+2PCS</p>	<p>V</p>  <p>M3×14mm 2PCS</p>	<p>W</p>  <p>Ø21mm 16+2PCS</p>	<p>X</p>  <p>Ø4×316mm 3PCS</p>
<p>CL</p>  <p>L300mm 1PC</p>	<p>CR</p>  <p>L300mm 1PC</p>	<p>DL</p>  <p>L300mm 1PC</p>	<p>DR</p>  <p>L300mm 1PC</p>

Assembly Steps(EN) / Montageschritte(DE)

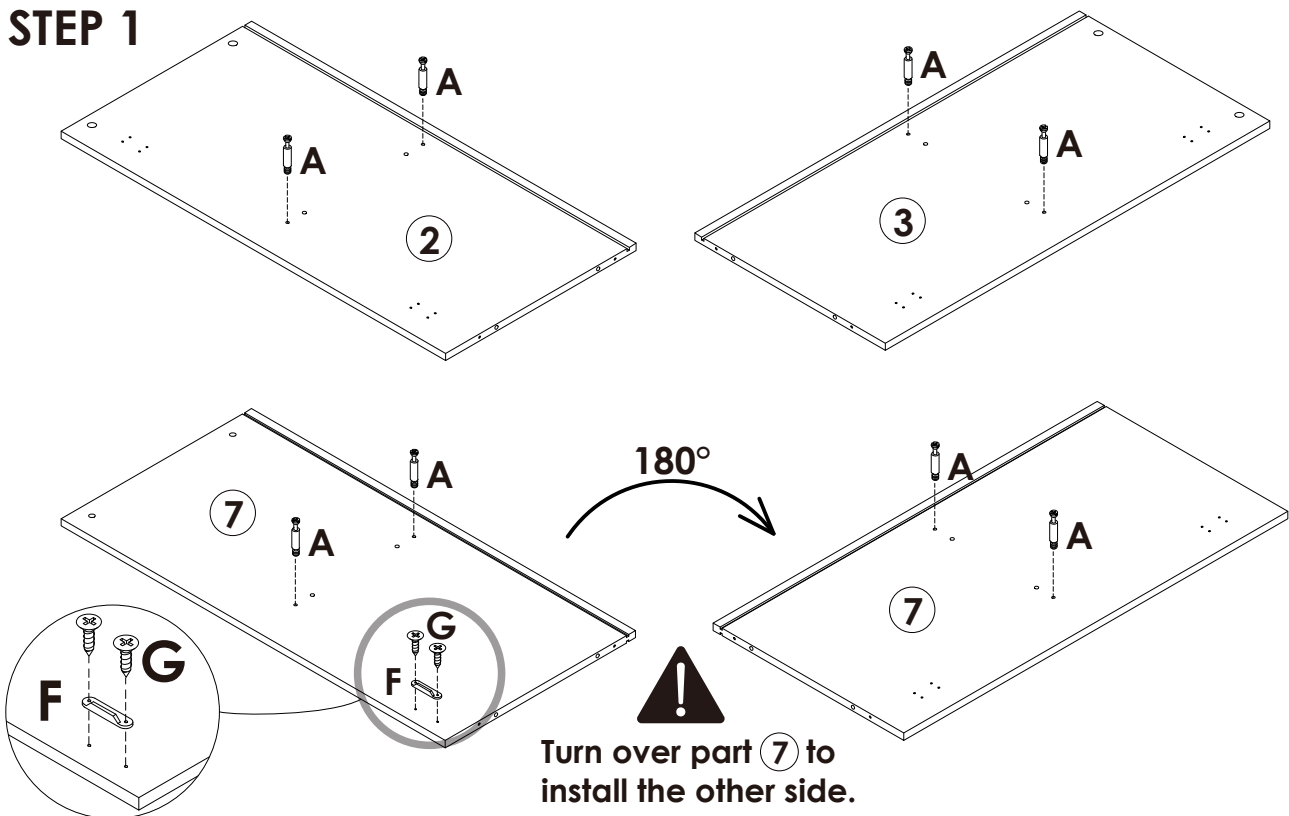
STEP 1

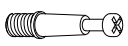

	A x 8PCS
	F x 1PC
	G x 2PCS

STEP 2

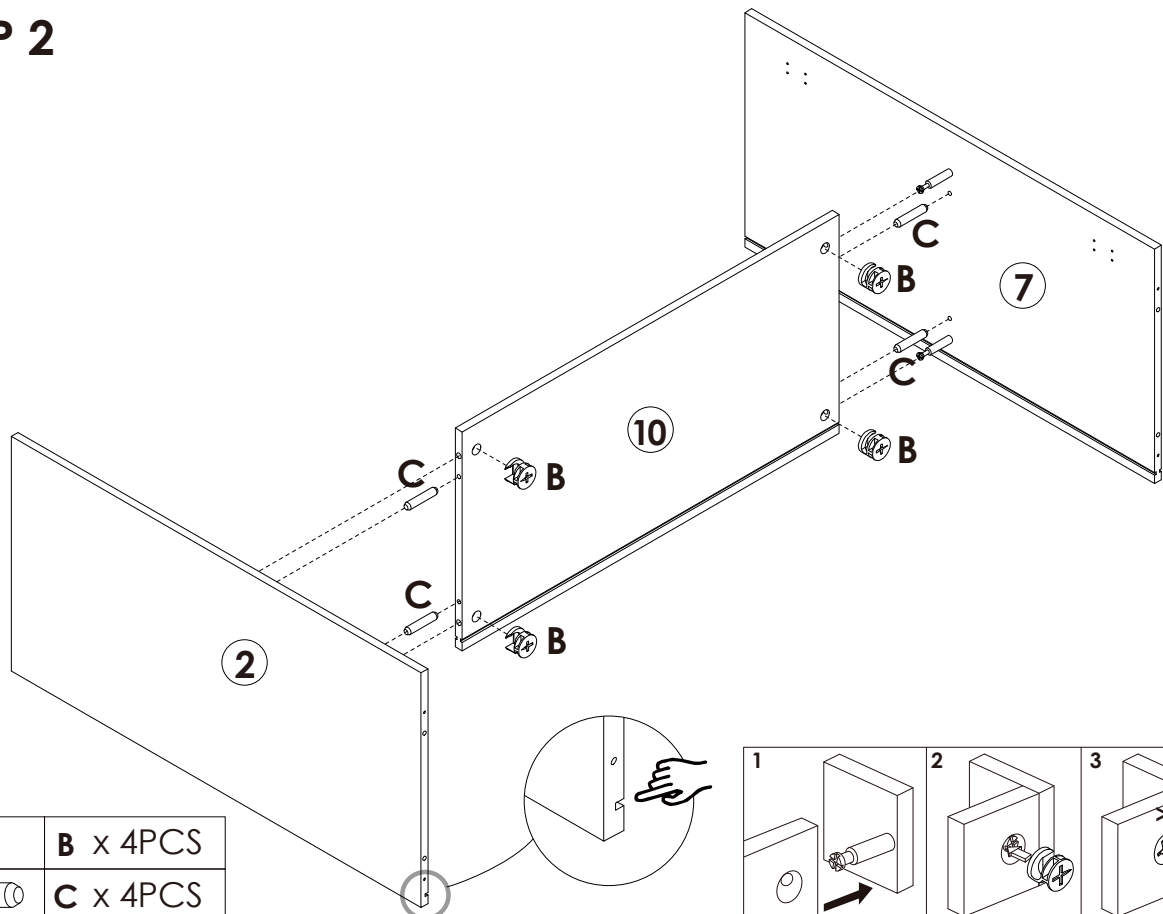

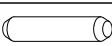
	B x 4PCS
	C x 4PCS

Assembly Steps(EN) / Montageschritte(DE)

STEP 3

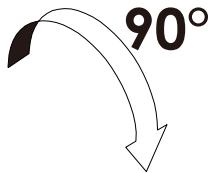
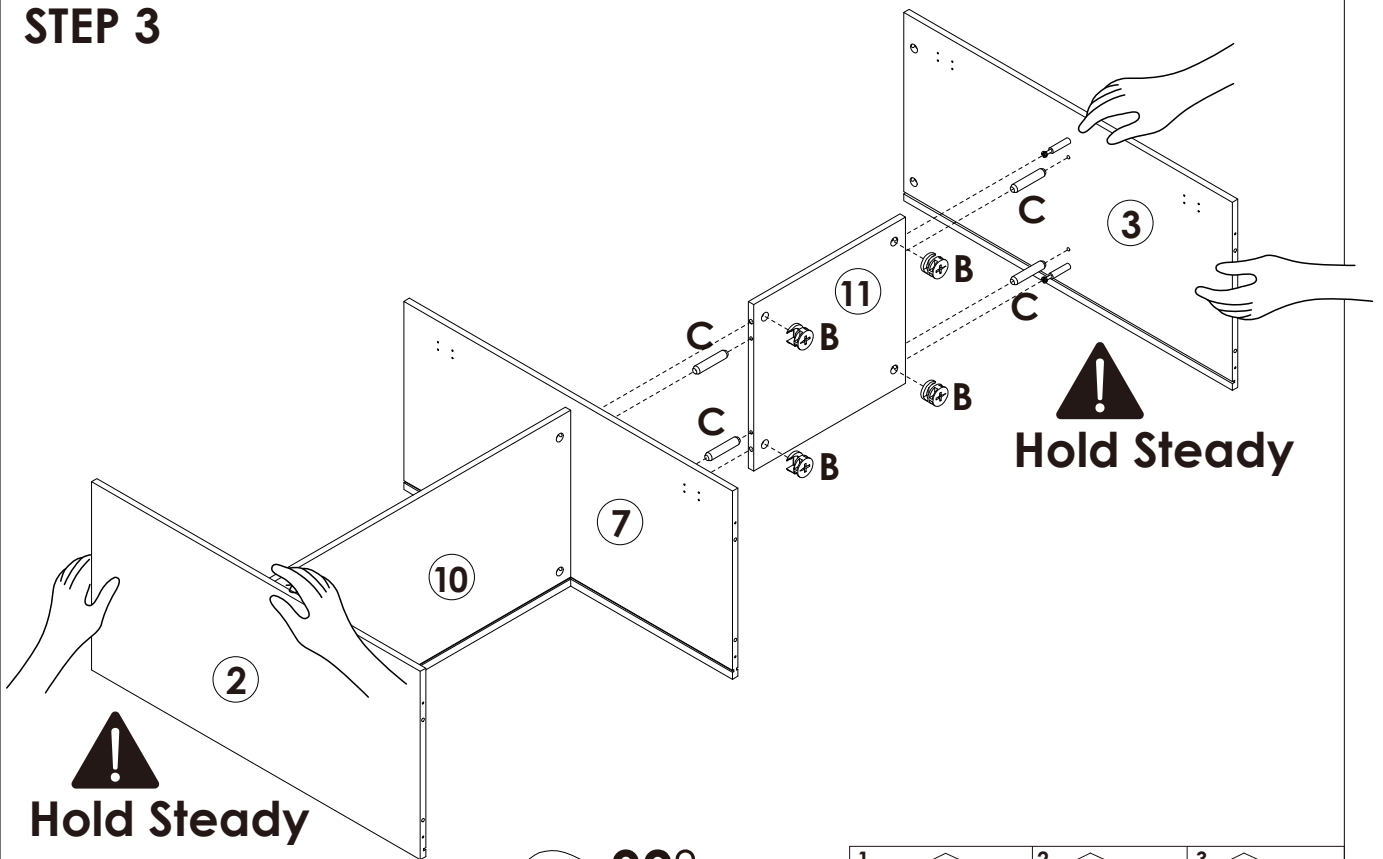

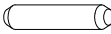
	B x 4PCS
	C x 4PCS

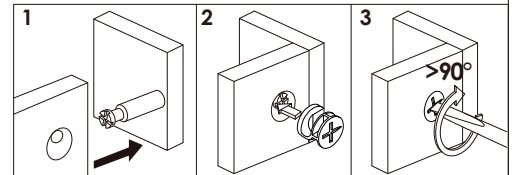

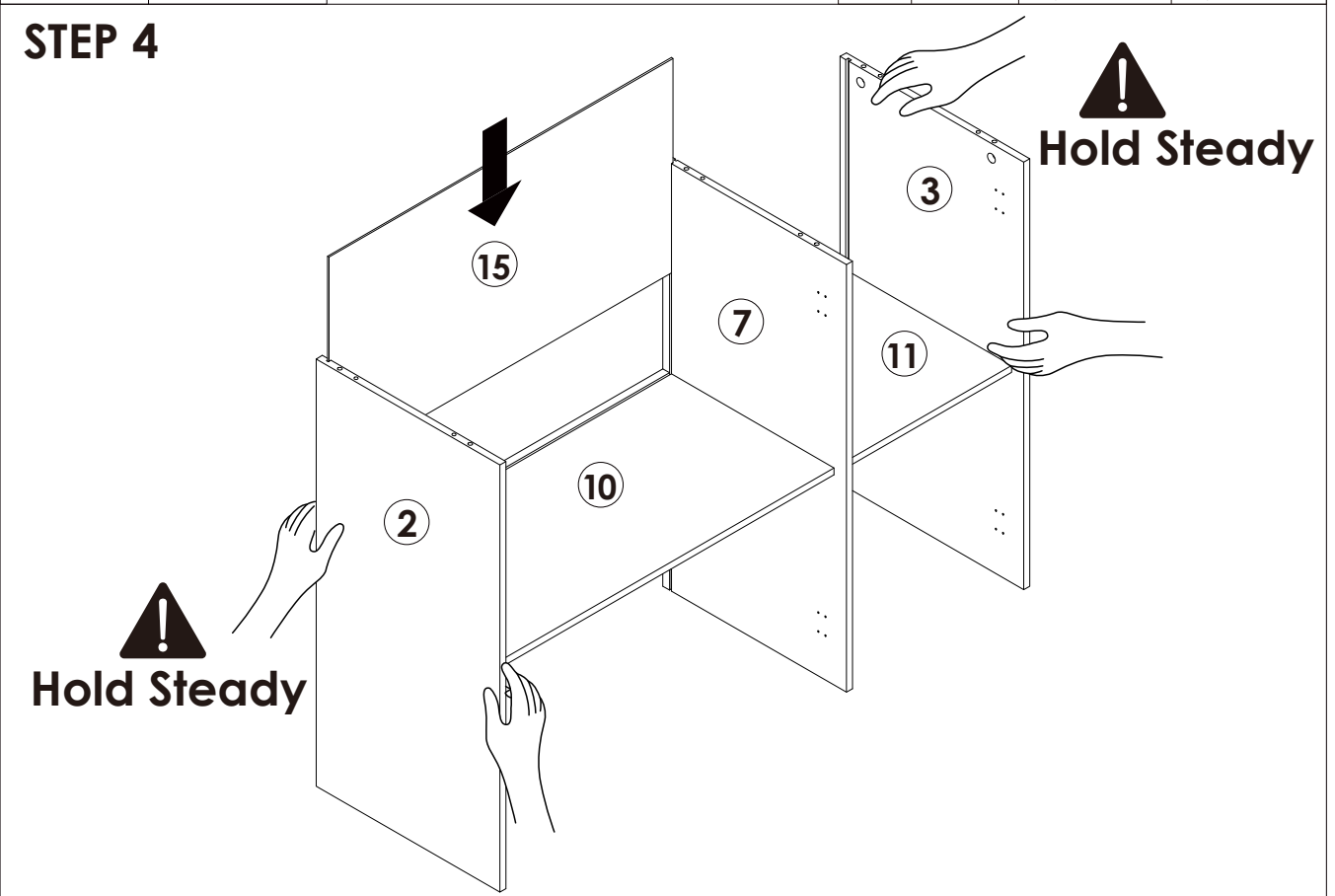

STEP 4



Assembly Steps(EN) / Montageschritte(DE)

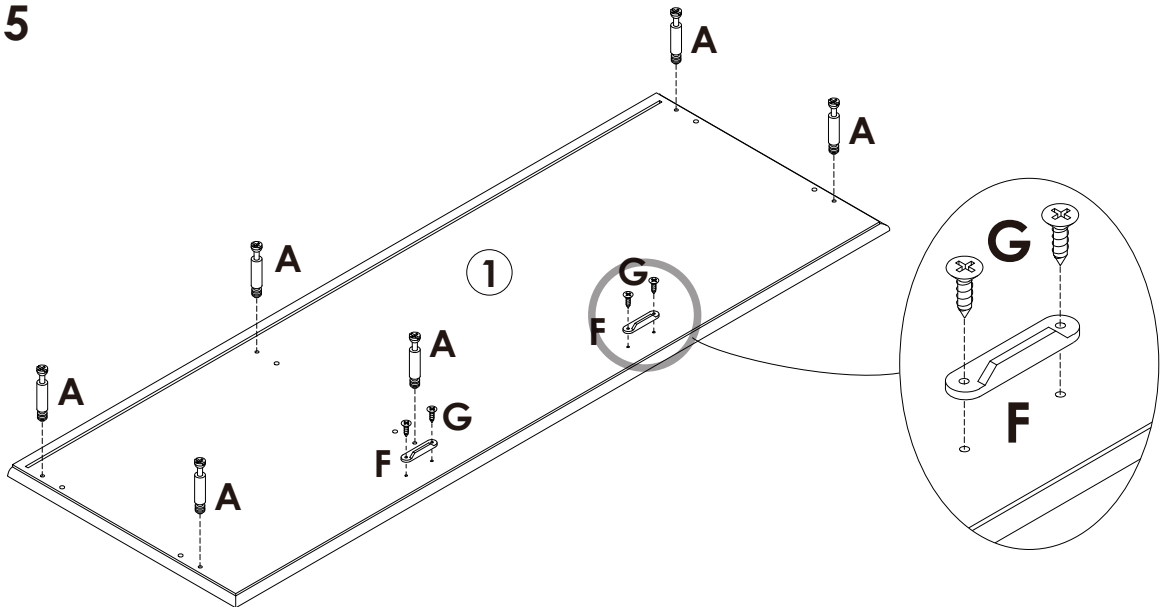

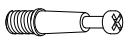
STEP 5

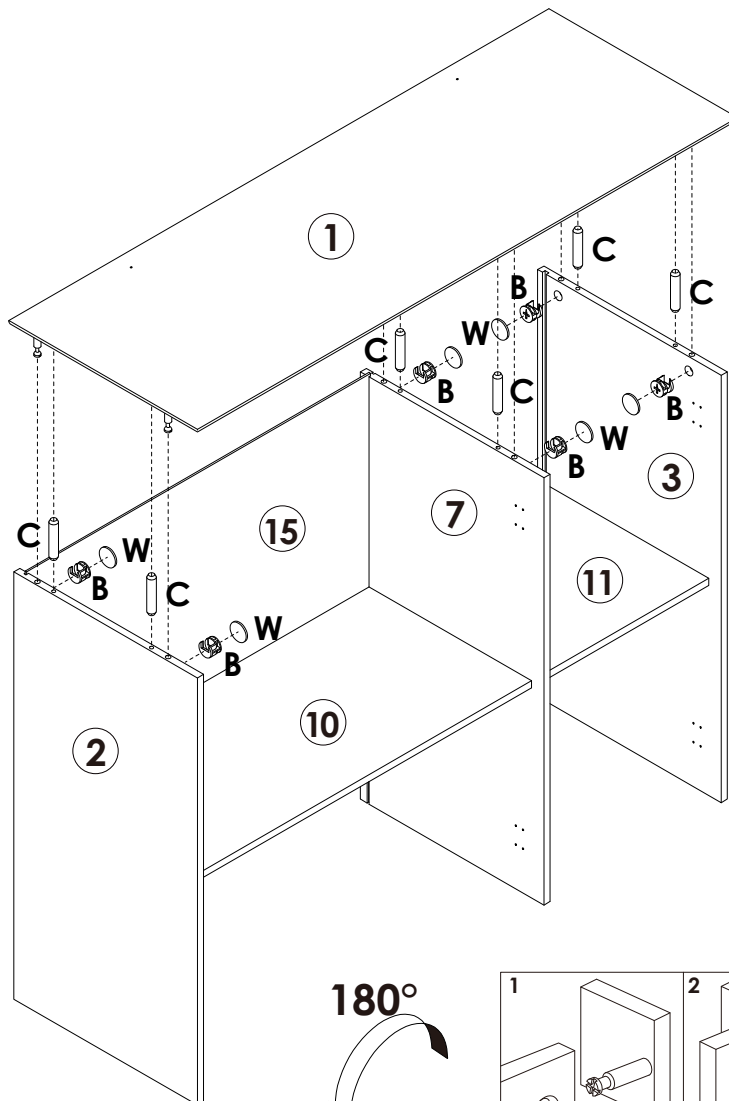
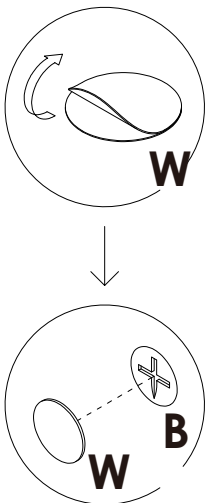

	A x 6PCS
	F x 2PCS
	G x 4PCS

STEP 6

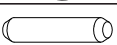

	B x 6PCS
	C x 6PCS
	W x 6PCS



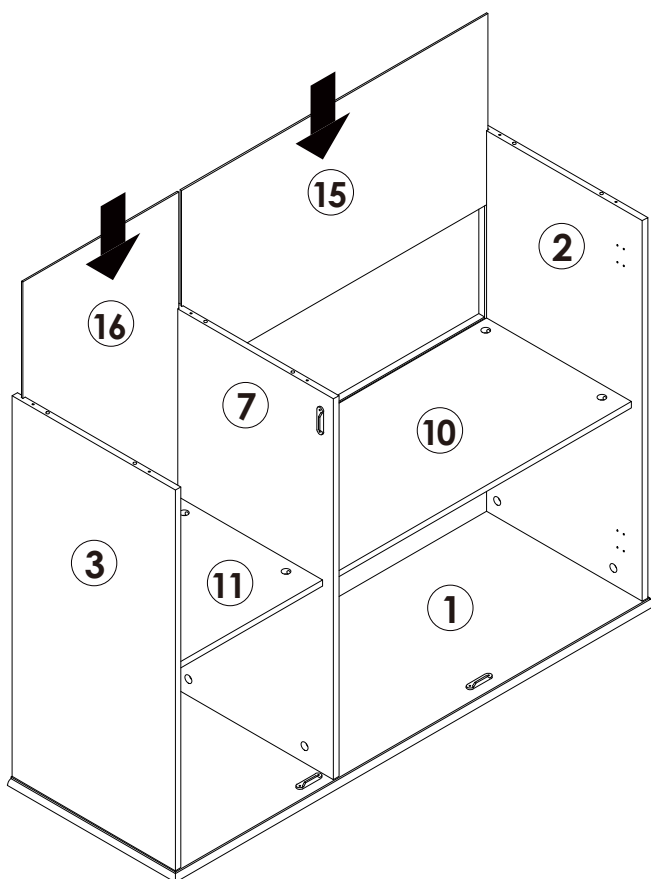

Assembly Steps(EN) / Montageschritte(DE)

STEP 7

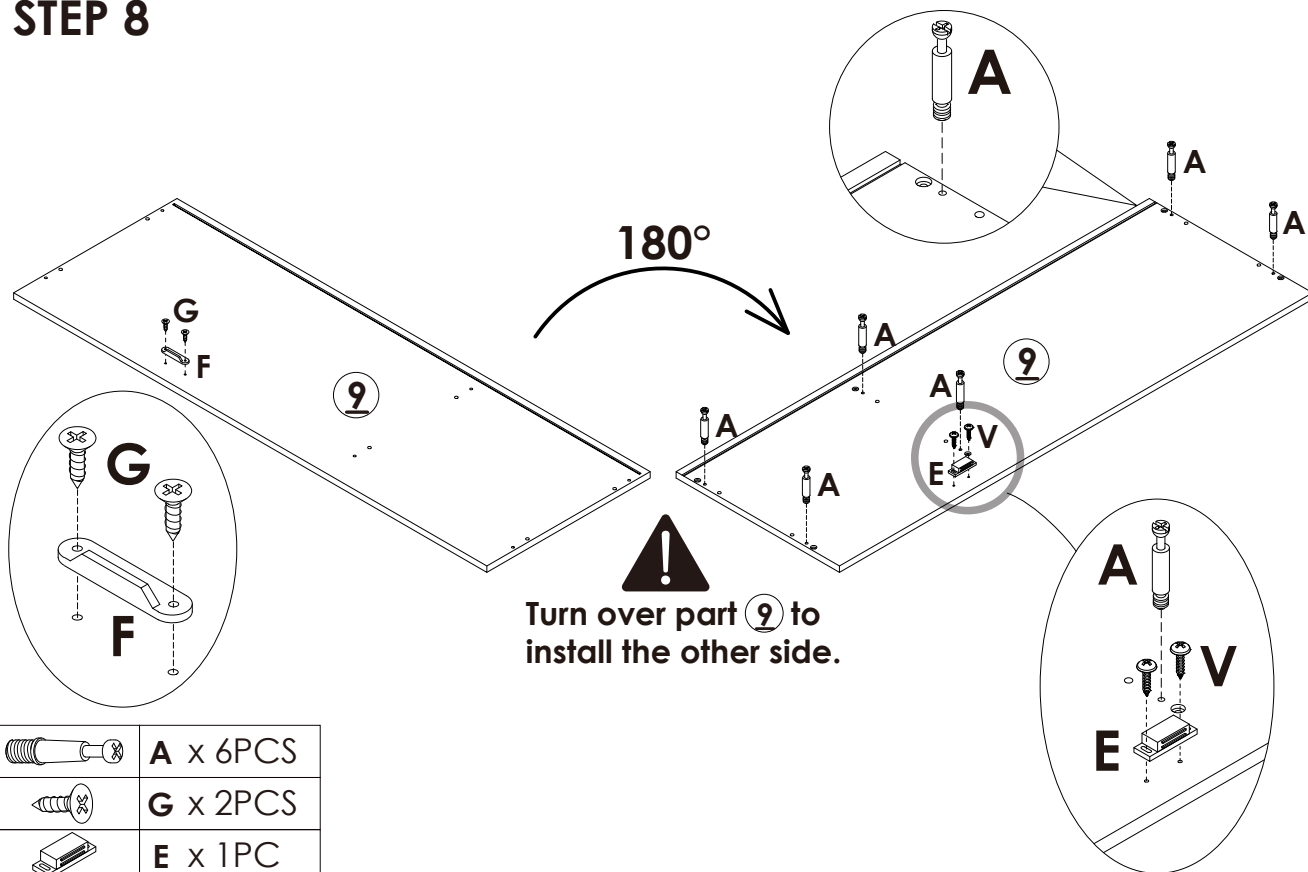

STEP 8



	A x 6PCS
	G x 2PCS
	E x 1PC
	F x 1PC
	V x 2PCS

Assembly Steps(EN) / Montageschritte(DE)

STEP 9

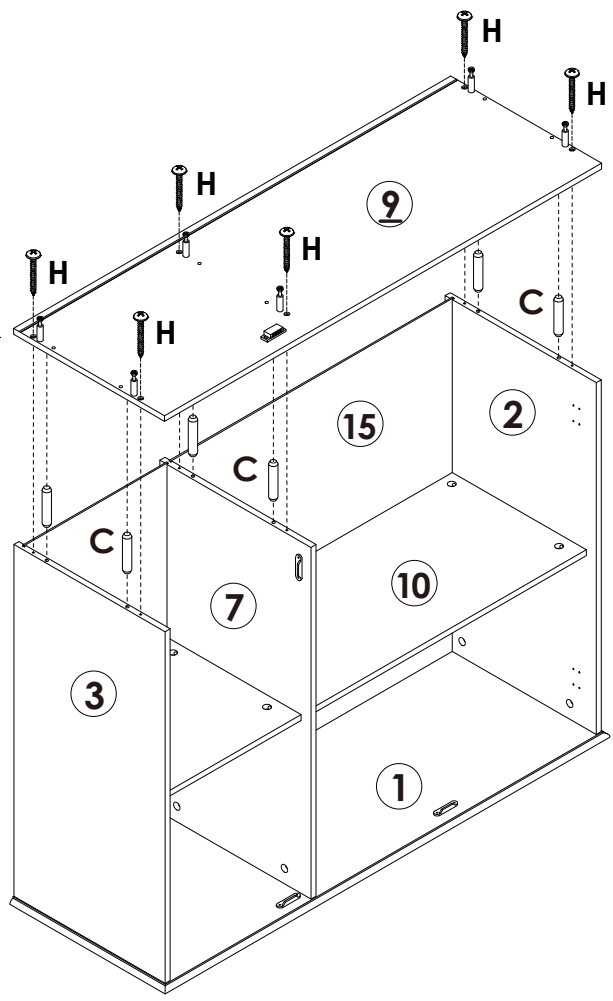
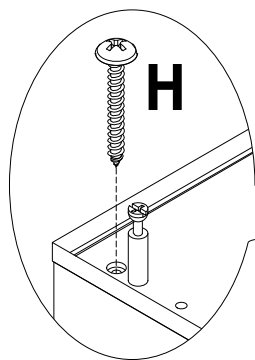

	C x 6PCS
	H x 6PCS

STEP 10

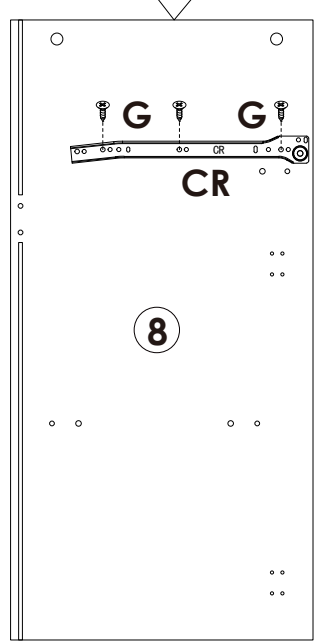
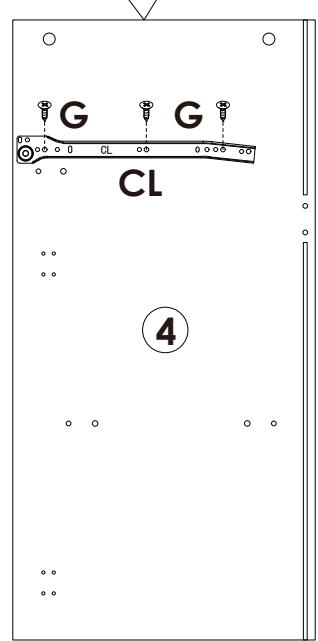
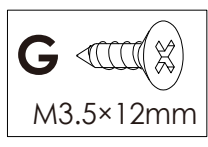
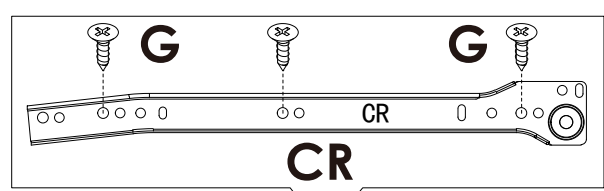
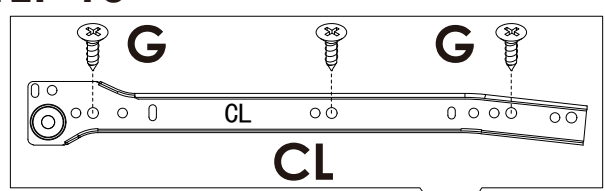

	G x 6PCS
	CL x 1PC
	CR x 1PC

Assembly Steps(EN) / Montageschritte(DE)

STEP 11

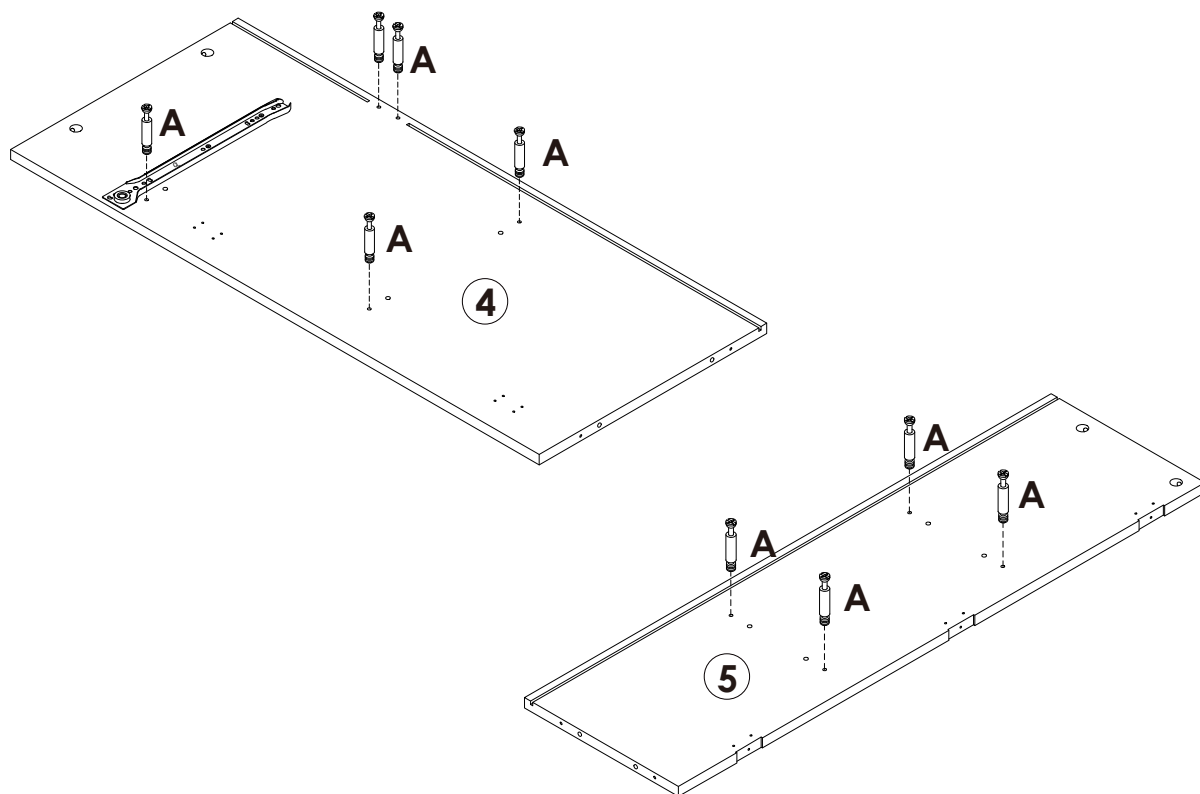

A x 9PCS

STEP 12

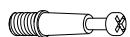
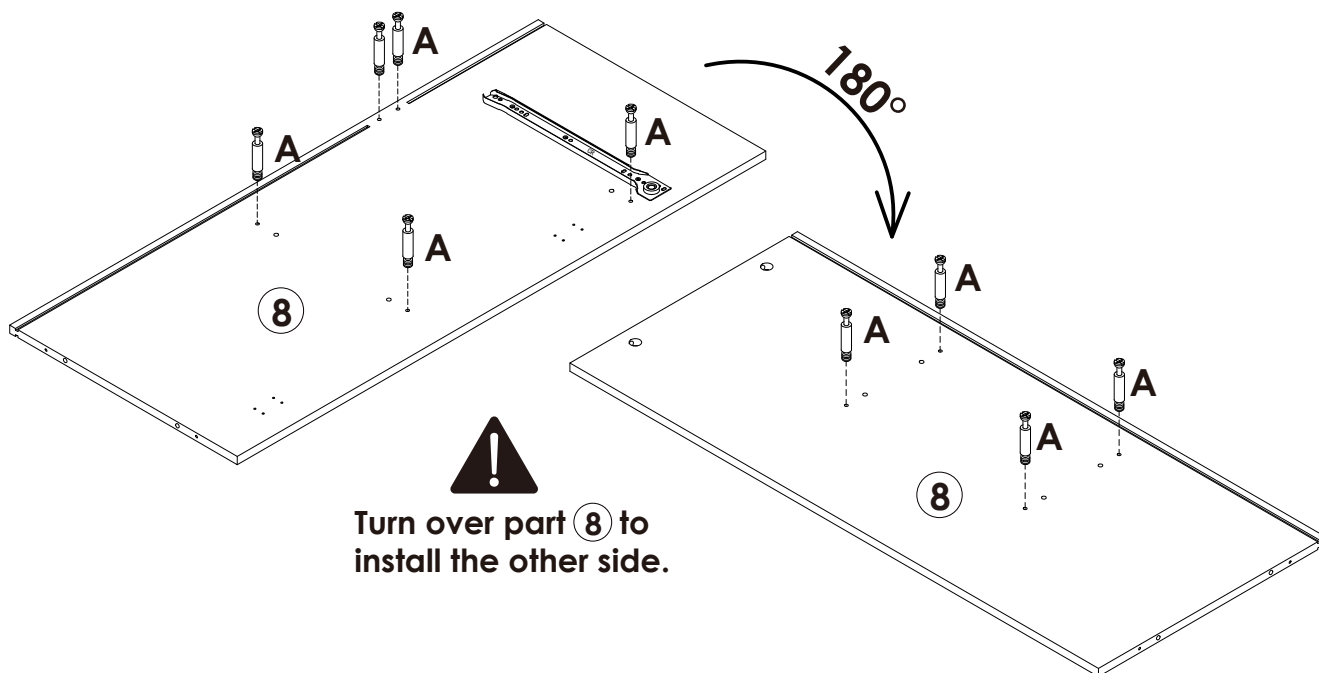

A x 9PCS

Assembly Steps(EN) / Montageschritte(DE)

STEP 13

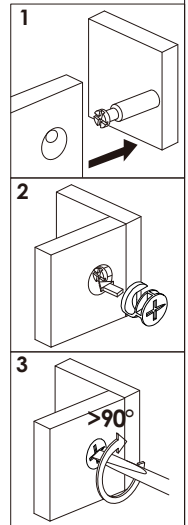
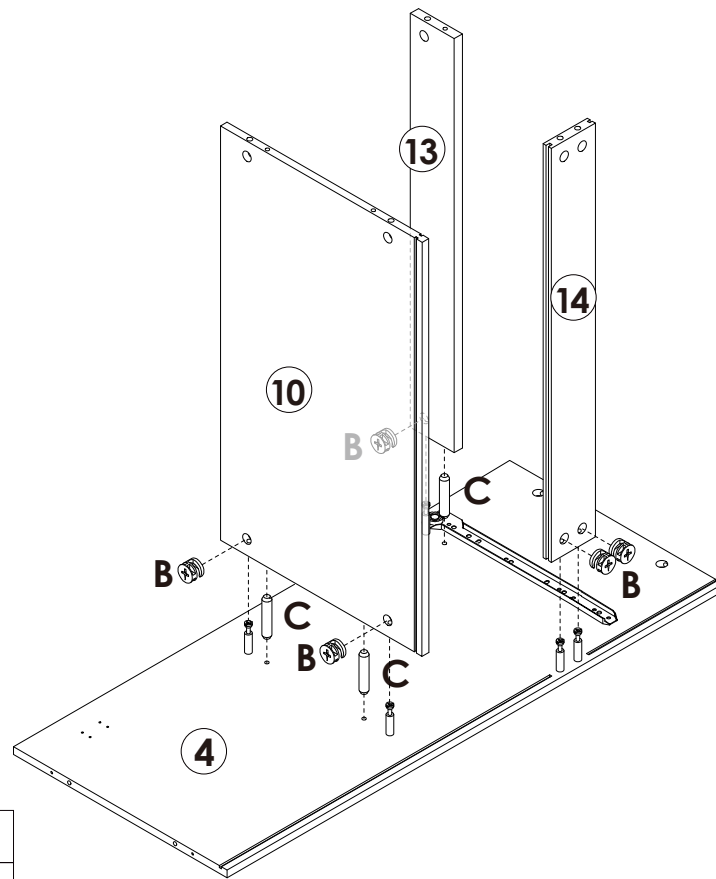

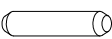
	B x 5PCS
	C x 3PCS

STEP 14

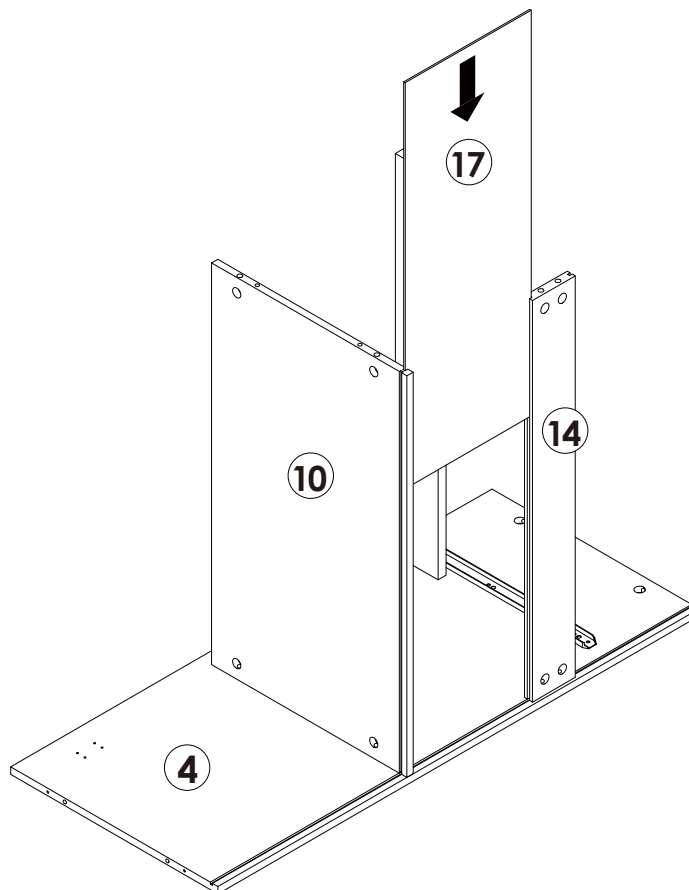

Assembly Steps(EN) / Montageschritte(DE)

STEP 15

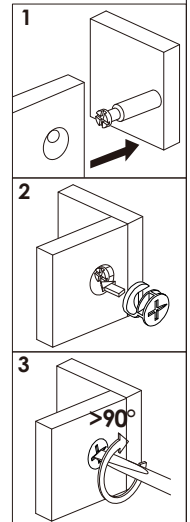
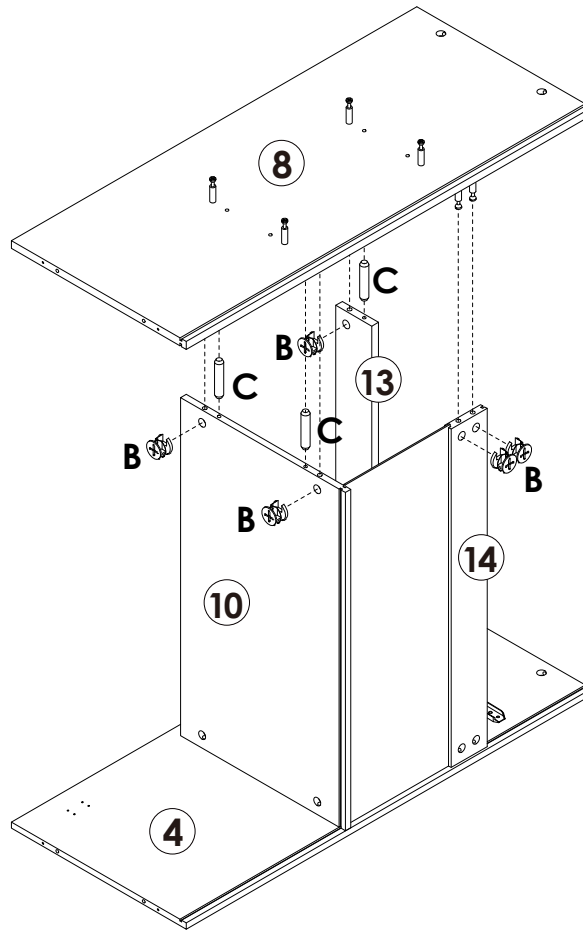

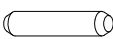
	B x 5PCS
	C x 3PCS

STEP 16

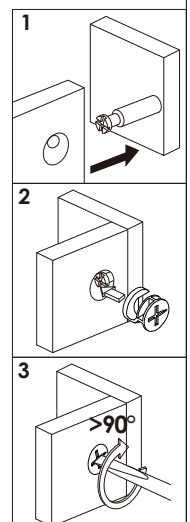
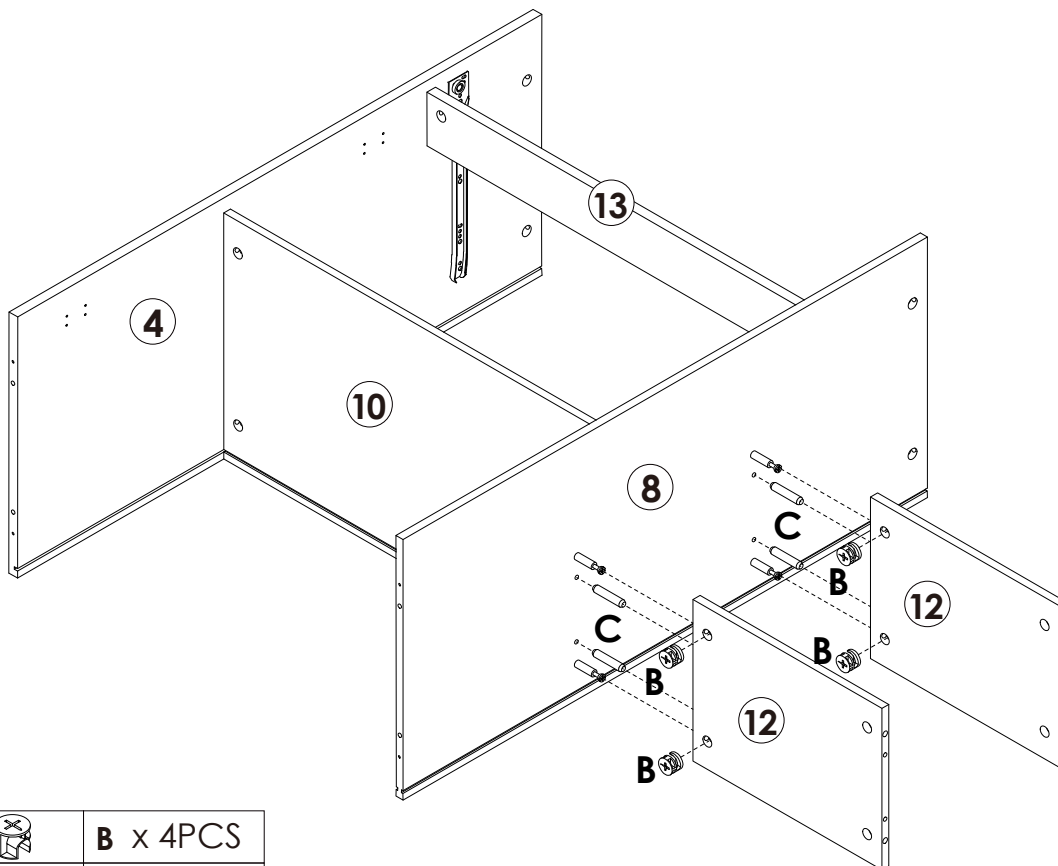

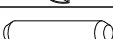
	B x 4PCS
	C x 4PCS

Assembly Steps(EN) / Montageschritte(DE)

STEP 17

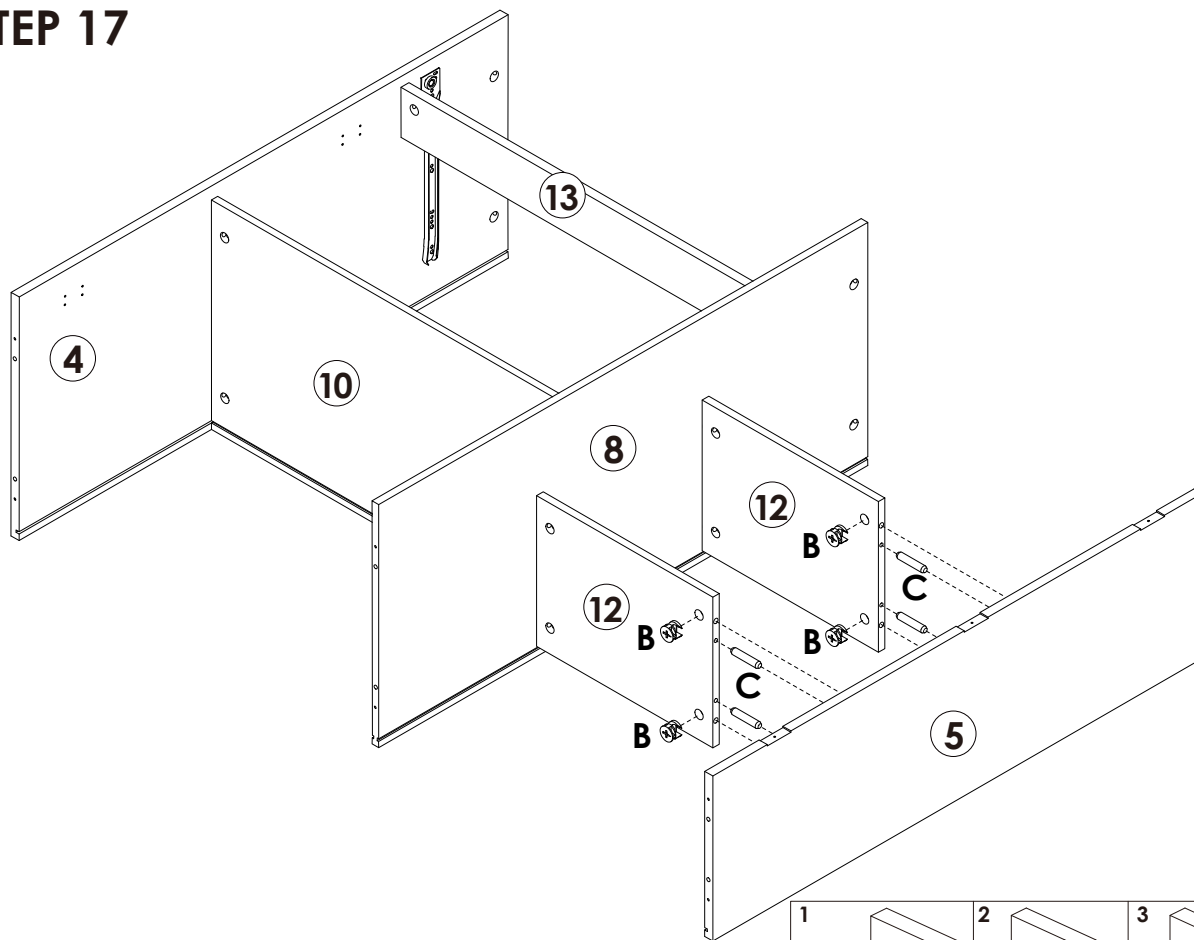

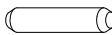
	B x 4PCS
	C x 4PCS

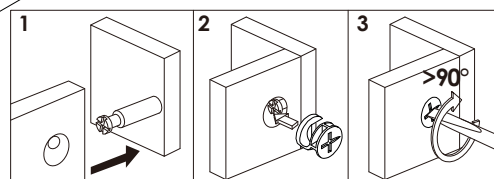



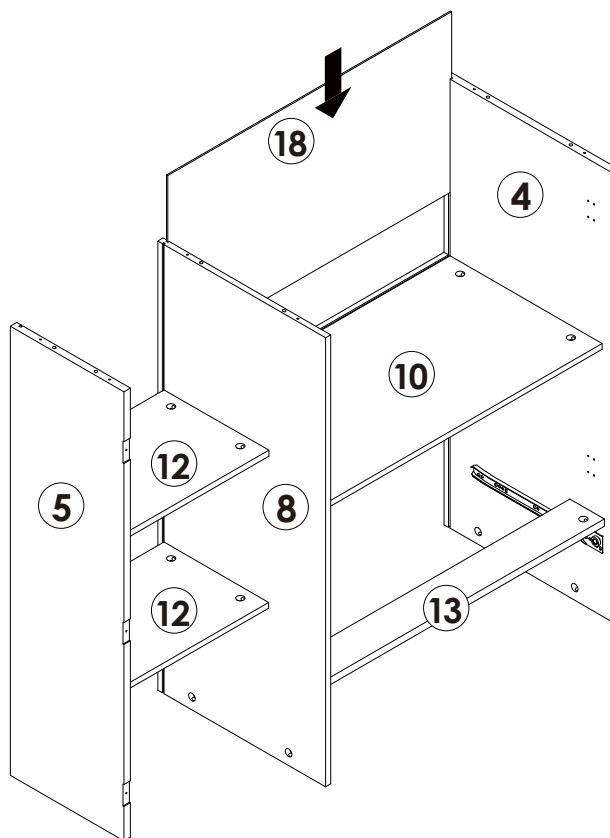

STEP 18

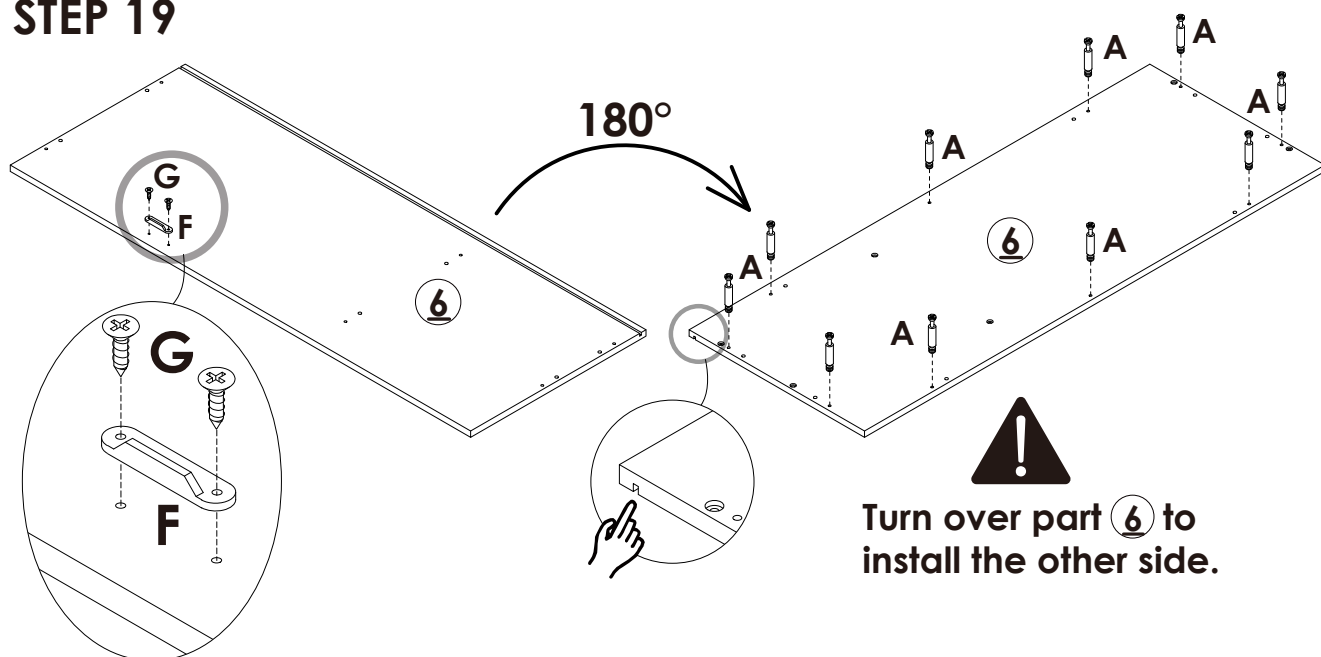

Assembly Steps(EN) / Montageschritte(DE)

STEP 19



	A x 10PCS
	F x 1PC
	G x 2PCS

STEP 20

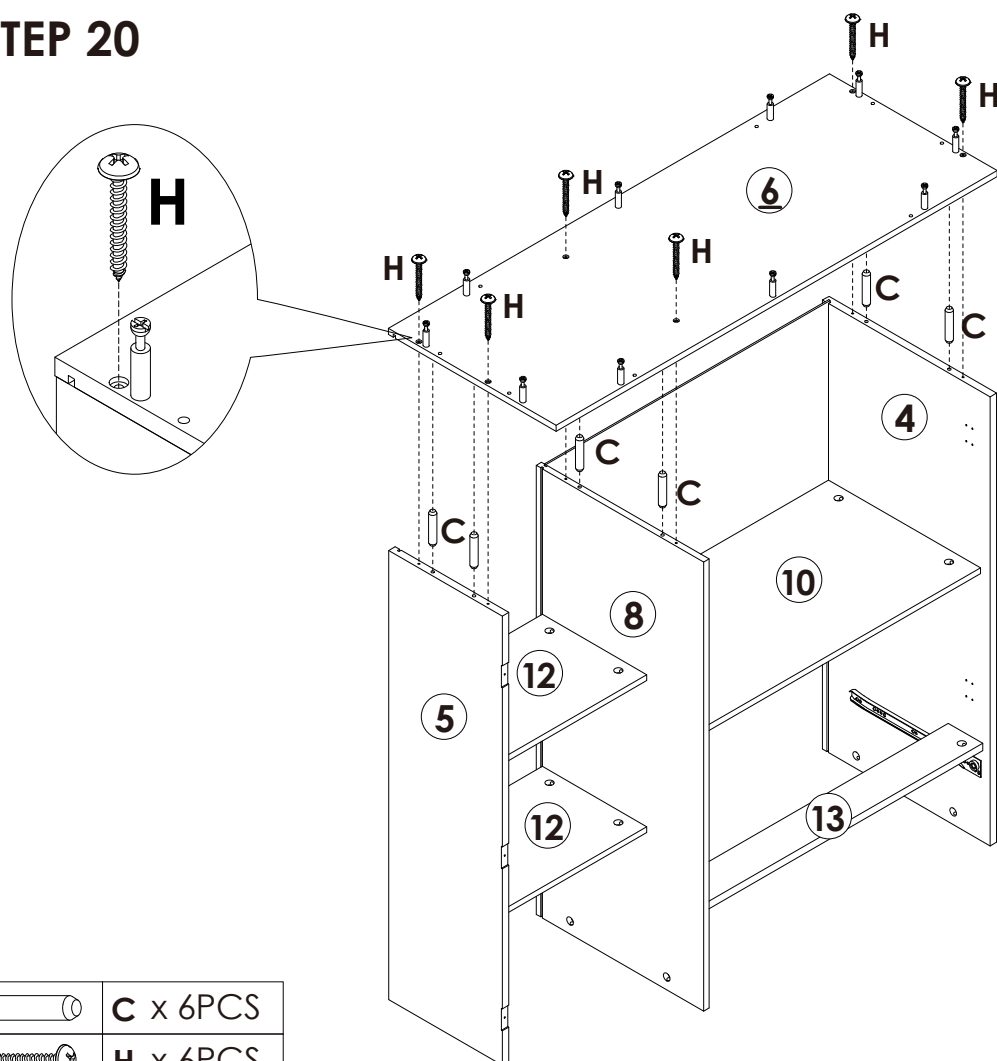

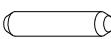
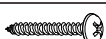
	C x 6PCS
	H x 6PCS

Assembly Steps(EN) / Montageschritte(DE)

STEP 21

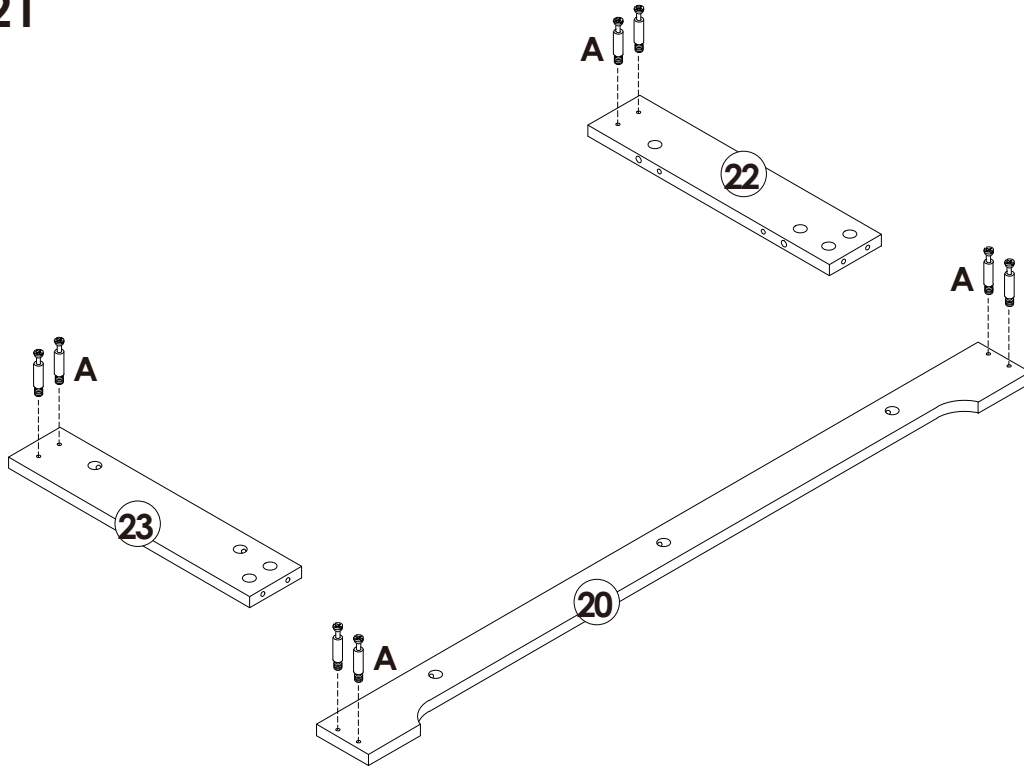

 A x 8PCS

STEP 22

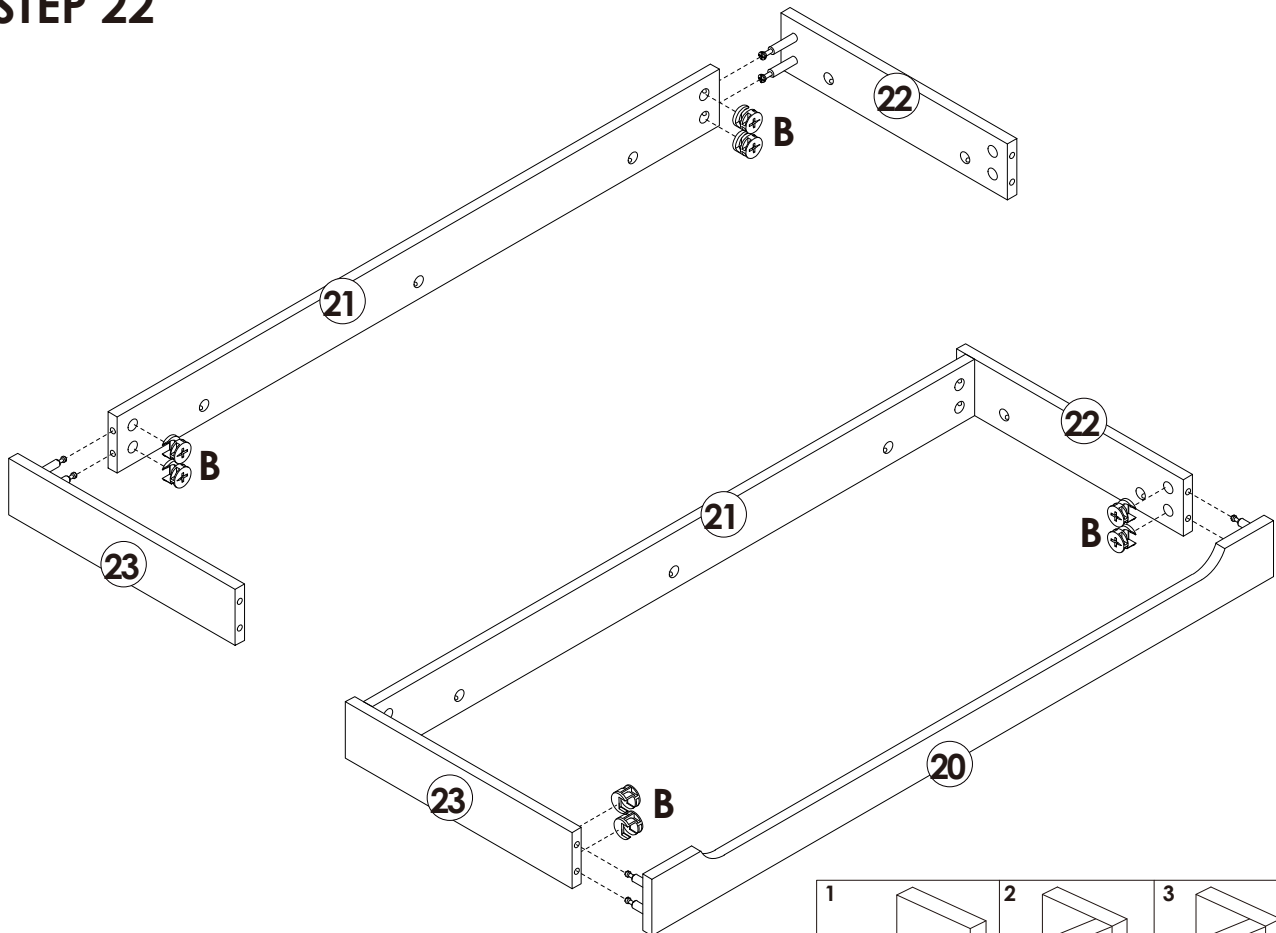

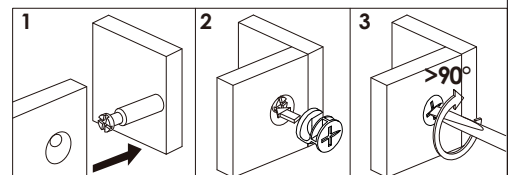

 B x 8PCS

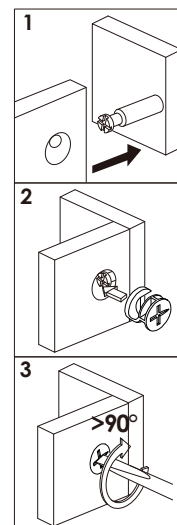
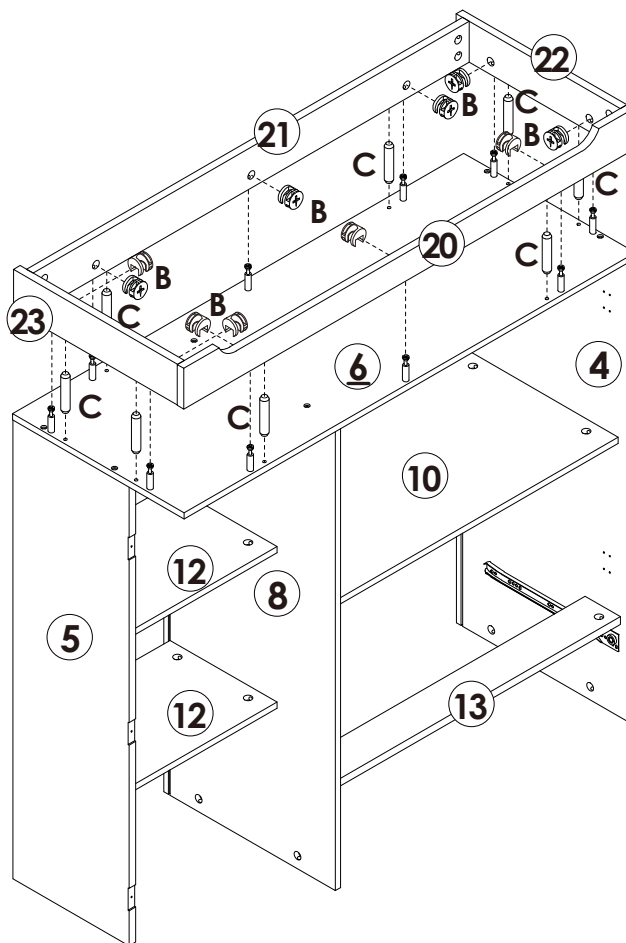

Assembly Steps(EN) / Montageschritte(DE)

STEP 23

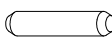

	B x 10PCS
	C x 8PCS

STEP 24

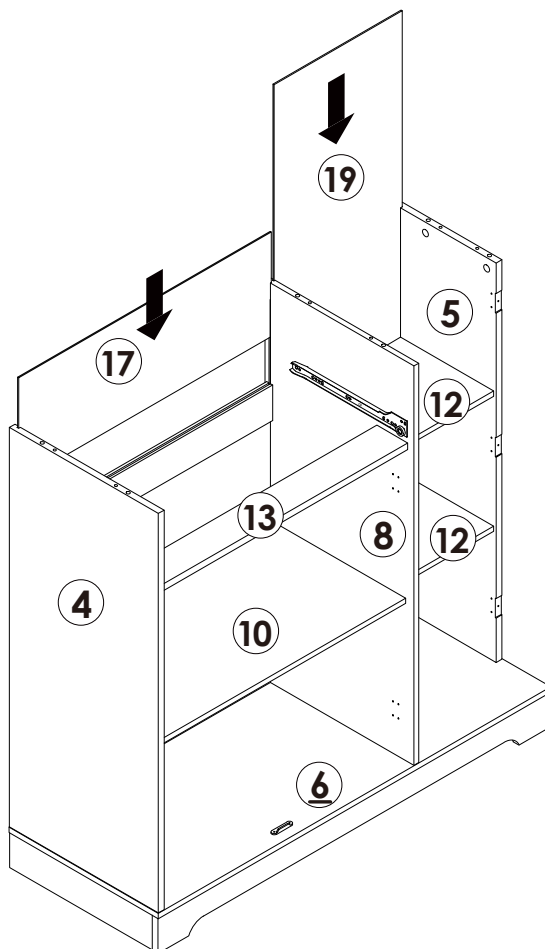

Assembly Steps(EN) / Montageschritte(DE)

STEP 25

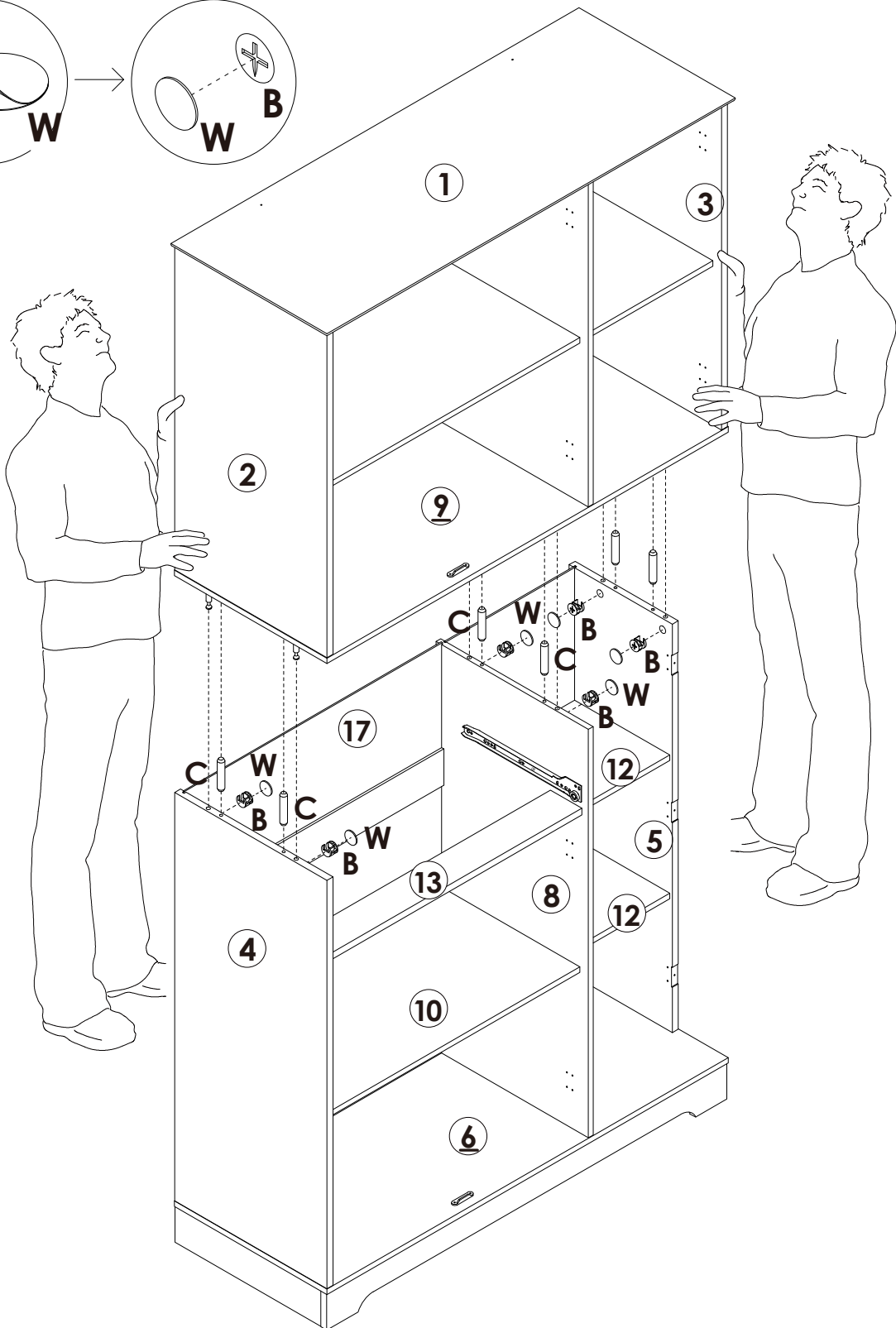
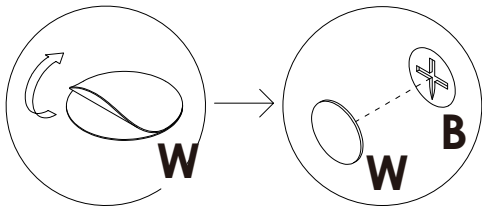

	B x 6PCS
	C x 6PCS
	W x 6PCS

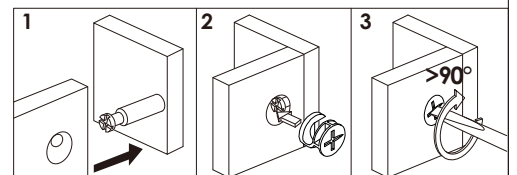



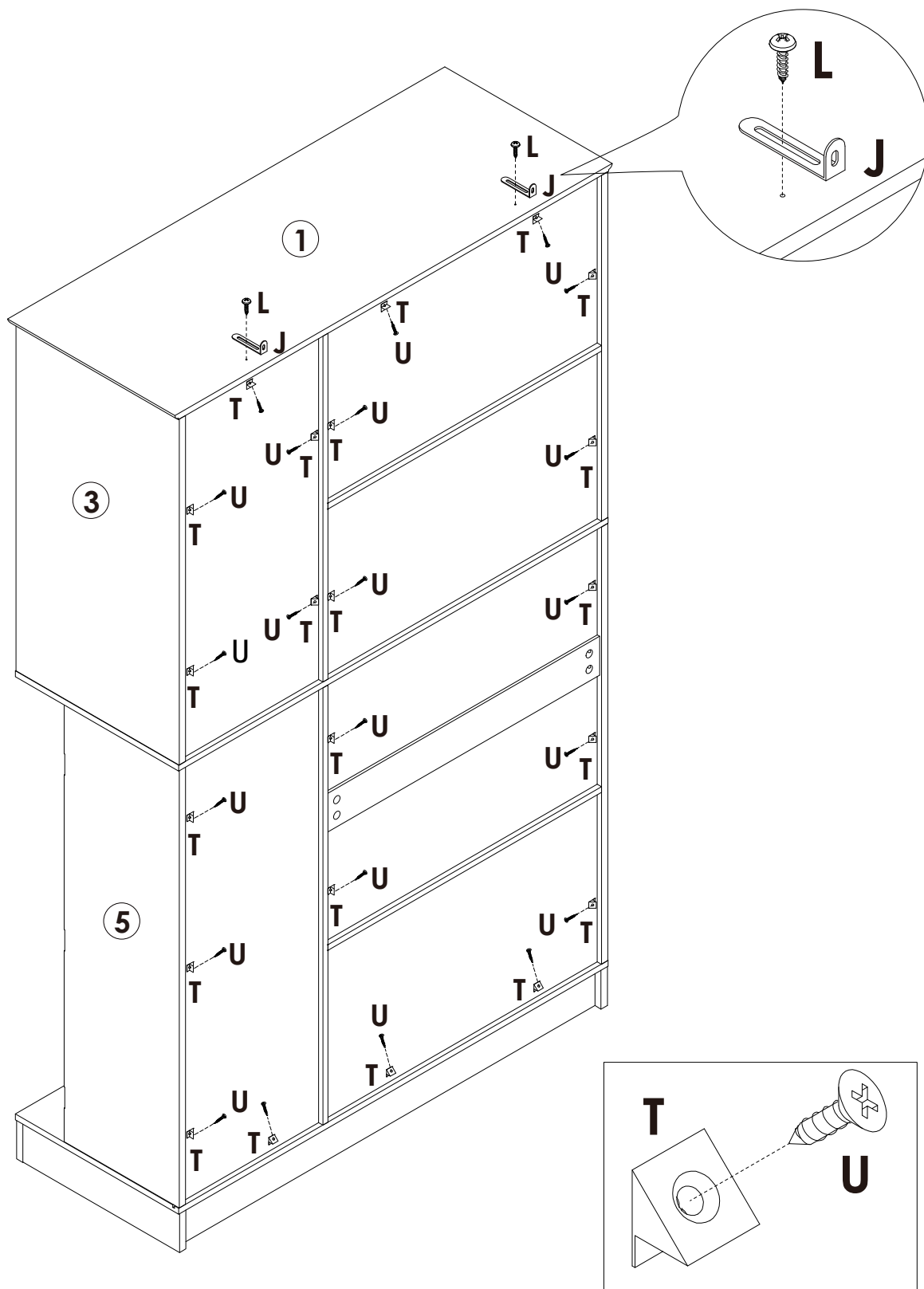

Assembly Steps(EN) / Montageschritte(DE)

STEP 26

Lock the long side of the "J" L-shaped metal plate to the ① board with the "L" short screw.



	J x 2PCS
	L x 2PCS
	T x 22PCS
	U x 22PCS

Assembly Steps(EN) / Montageschritte(DE)

STEP 27

WALL

Drill 2 holes on the wall at the required position for anti-falling device installation.

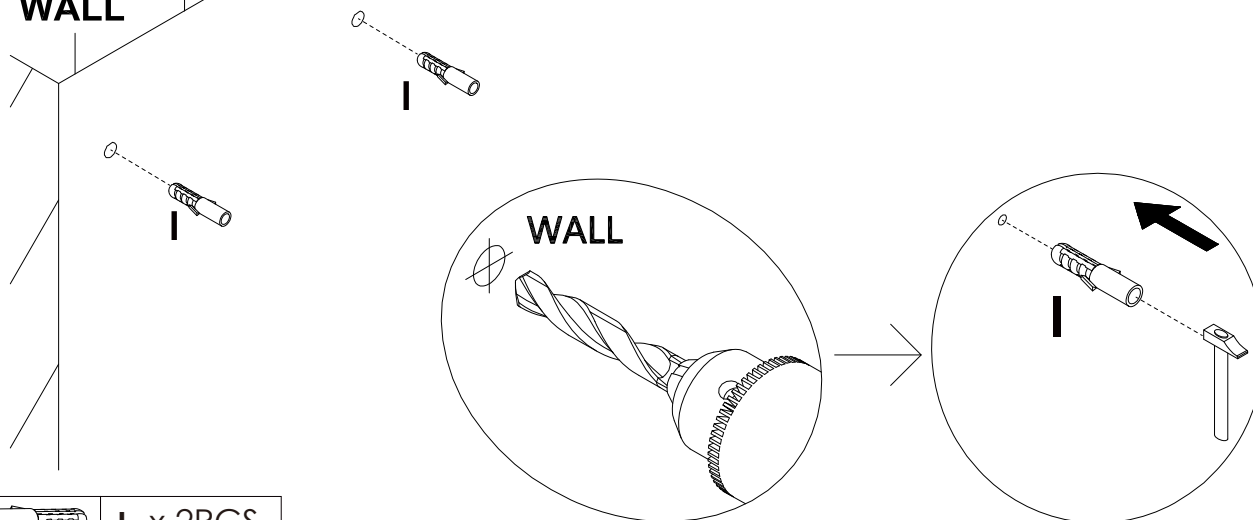

I x 2PCS

STEP 28

Move the cabinet to the required position, use the "J" long screw to fix the cabinet to the wall.

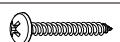
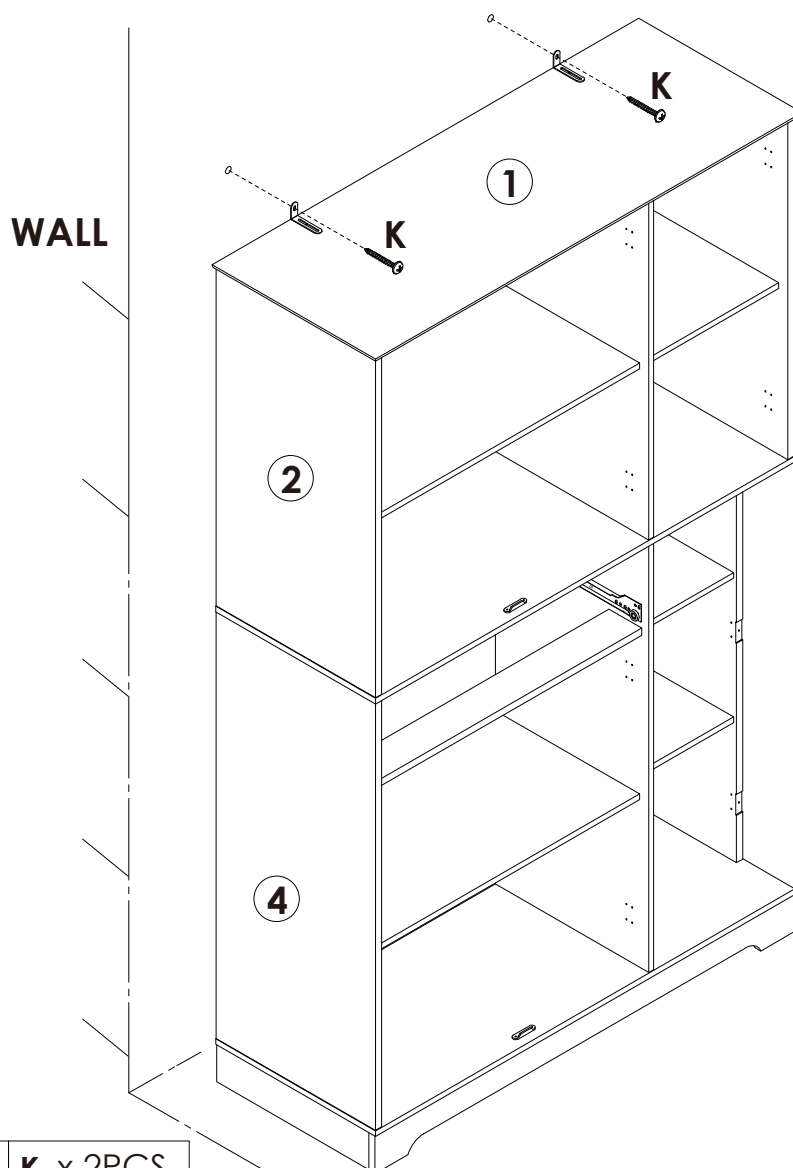

K x 2PCS

Assembly Steps(EN) / Montageschritte(DE)

STEP 29

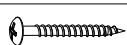
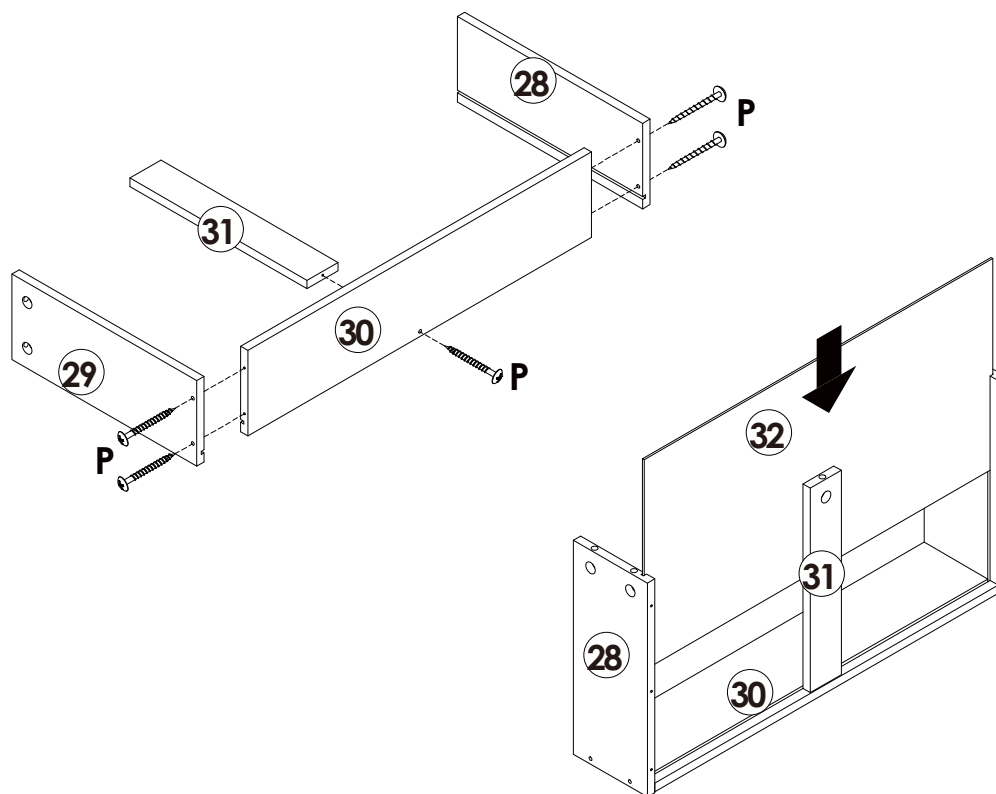

P x 5PCS

STEP 30

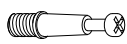
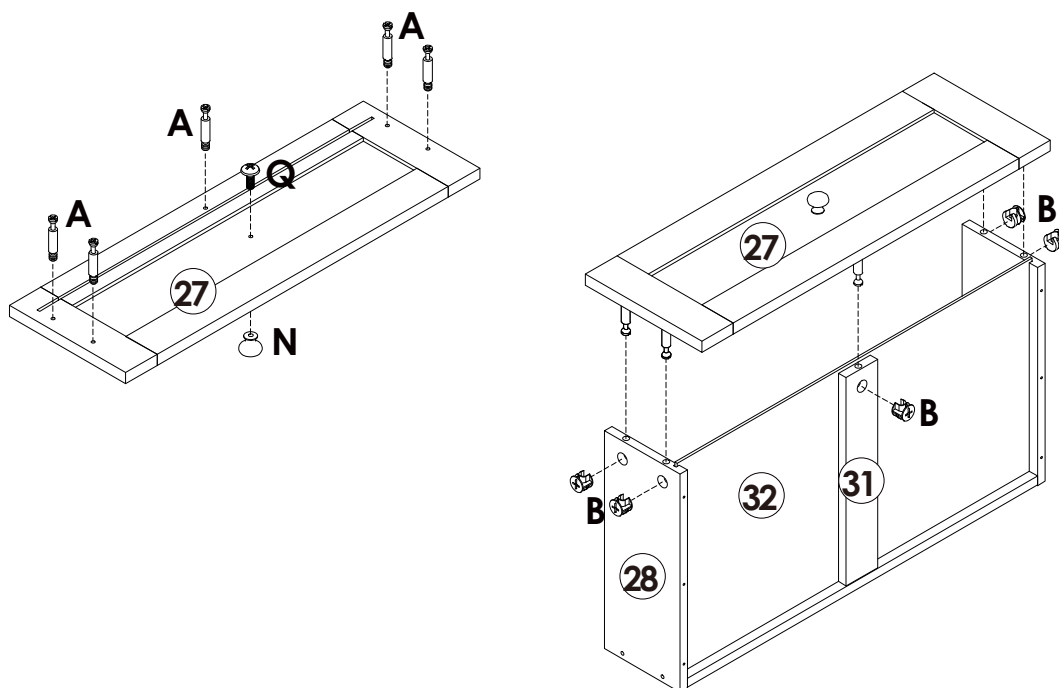

A x 5PCS



B x 5PCS



N x 1PC





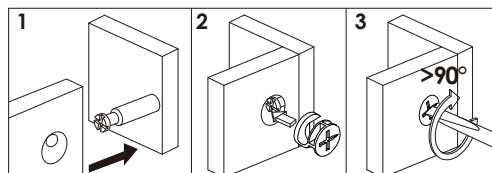

Q x 1PC

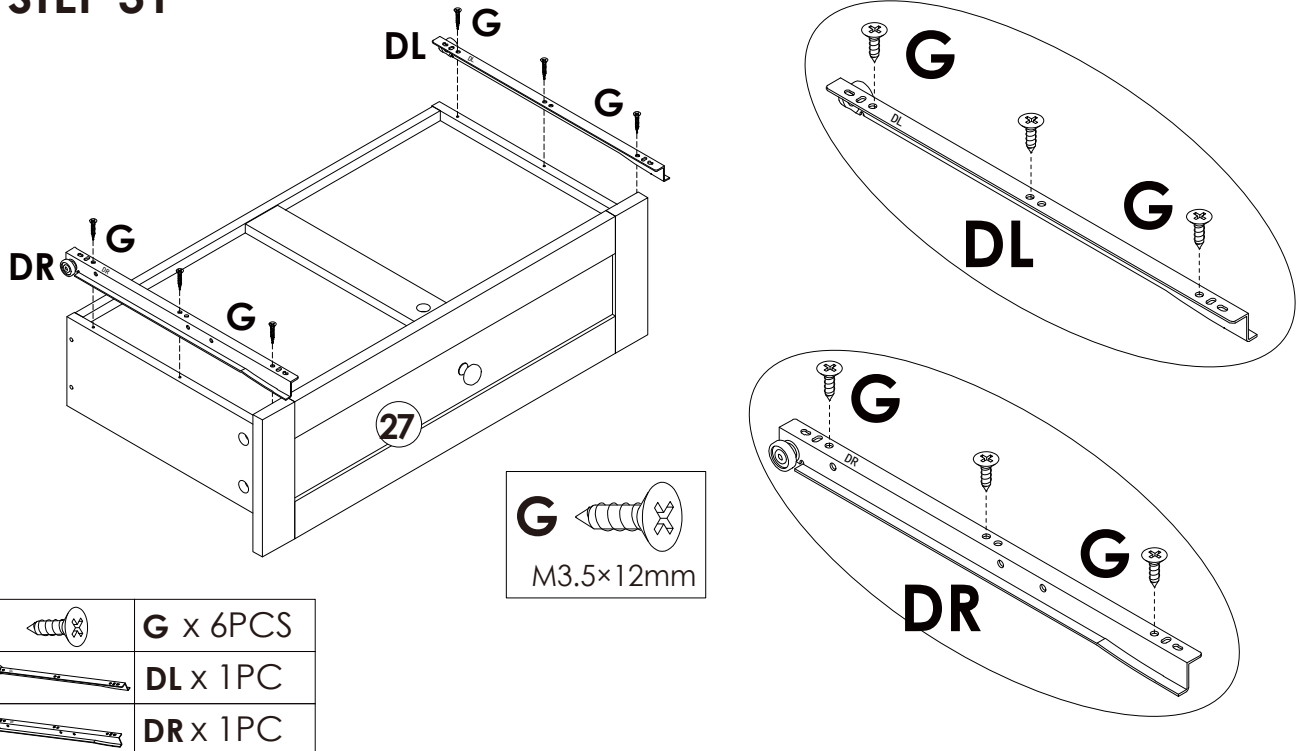

Assembly Steps(EN) / Montageschritte(DE)





STEP 31

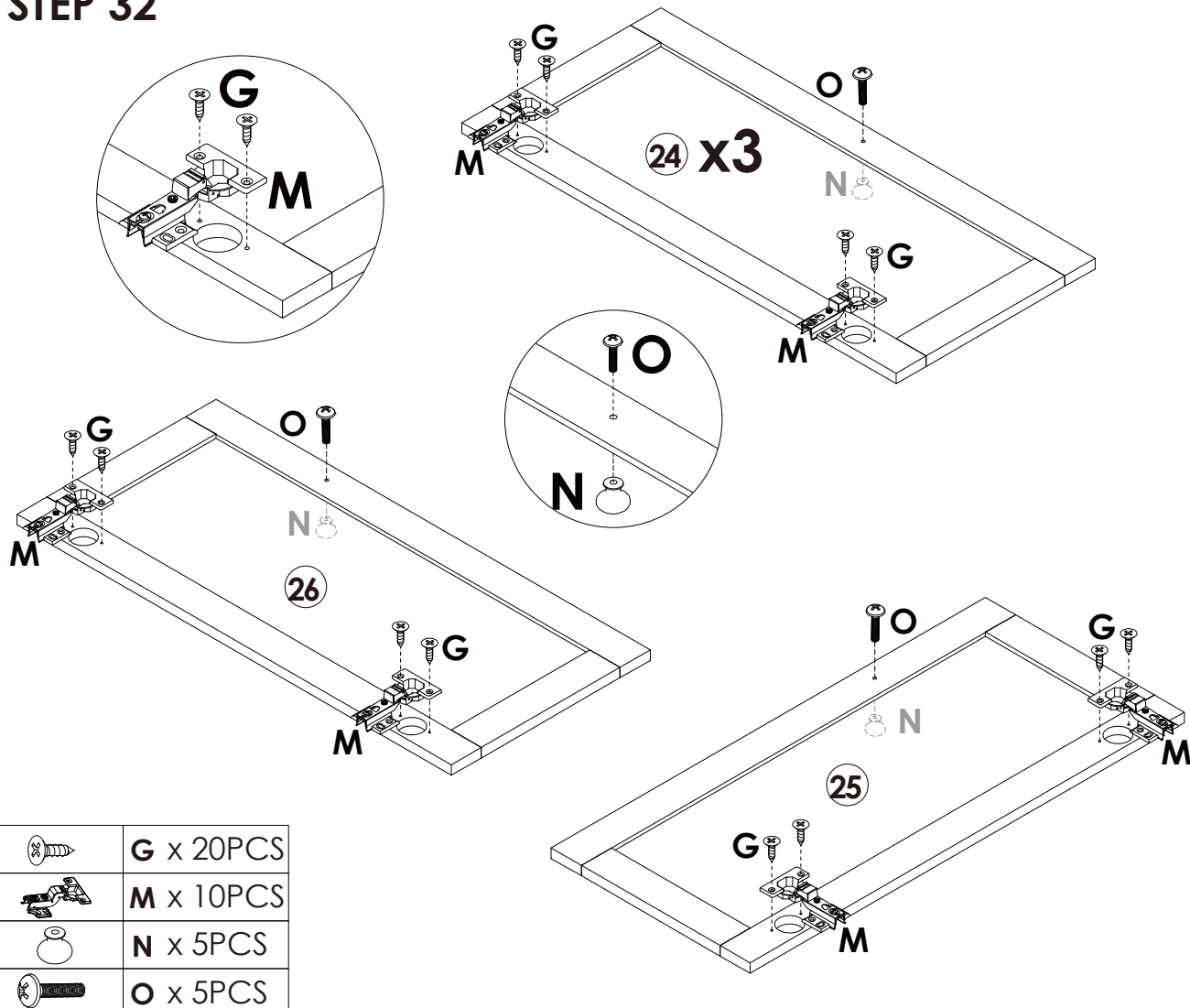

	G x 6PCS
	DL x 1PC
	DR x 1PC

STEP 32



	G x 20PCS
	M x 10PCS
	N x 5PCS
	O x 5PCS

Assembly Steps(EN) / Montageschritte(DE)

STEP 33

When the hinges are installed, you can refer to the pictures to adjust crevice of the doors till it's perfect:

1. To adjust the doors up and down, please refer to step (a)
2. To adjust the distance between the doors and side panels, please refer to step (b)
3. To adjust the gap between two doors, please refer to step (c)
4. After the adjustment finished, please tight the screws, refer to step (d)

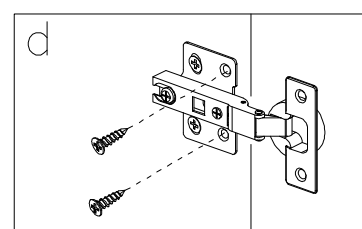
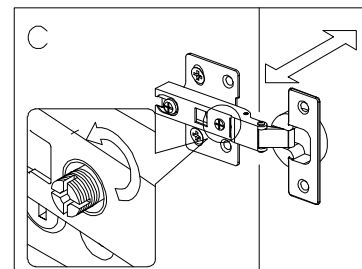
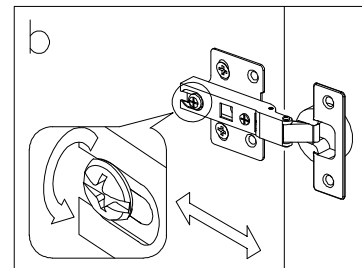
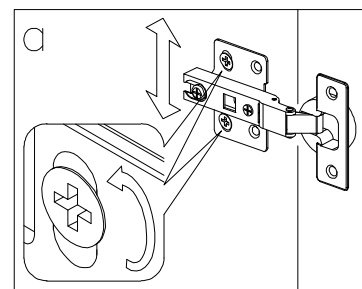
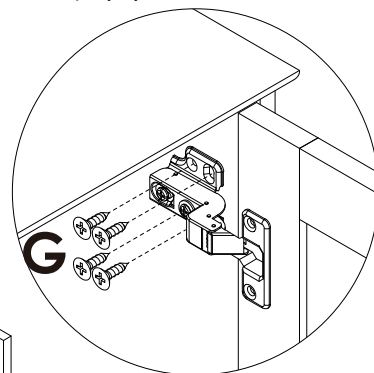
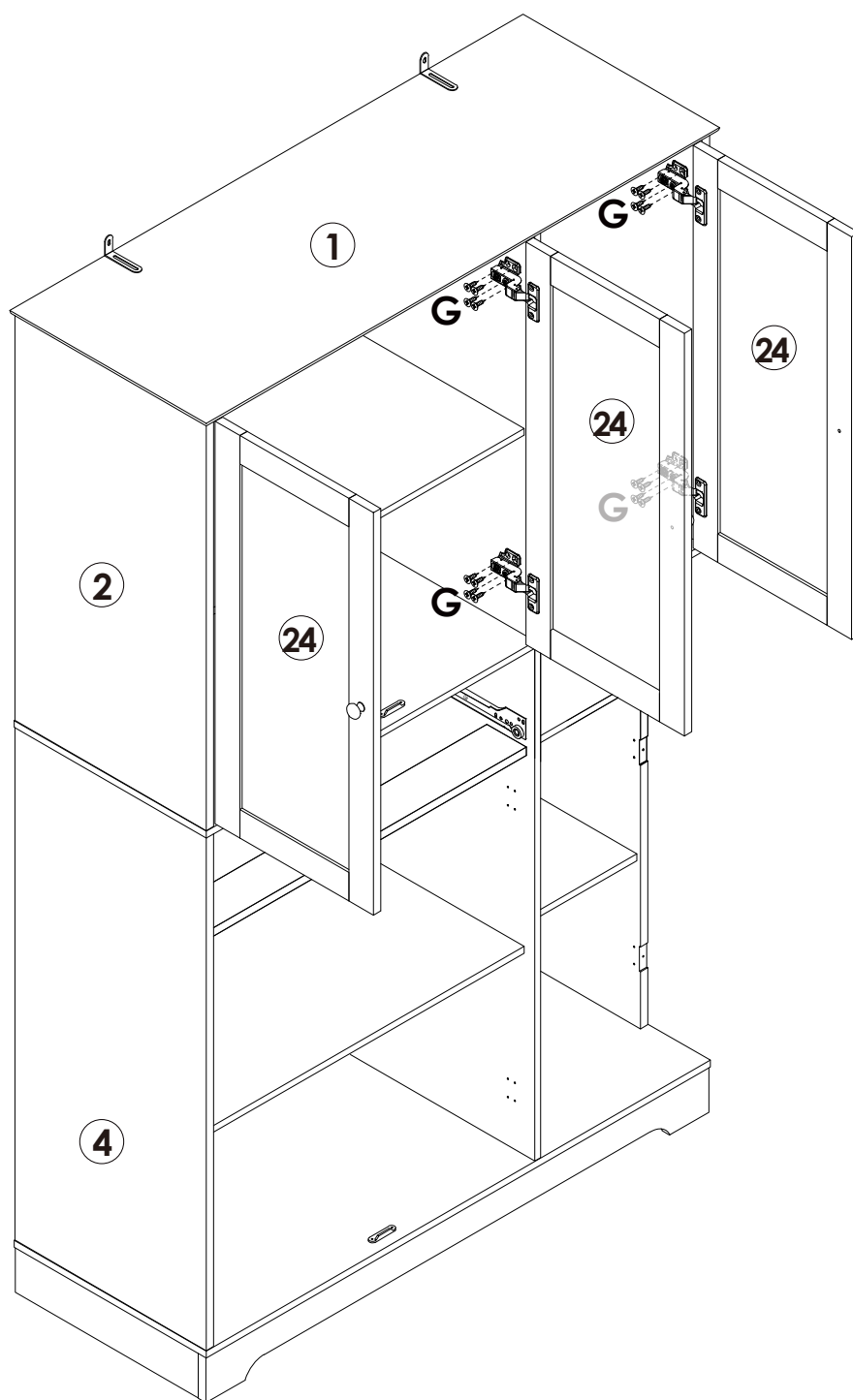

G x 24PCS

STEP 34

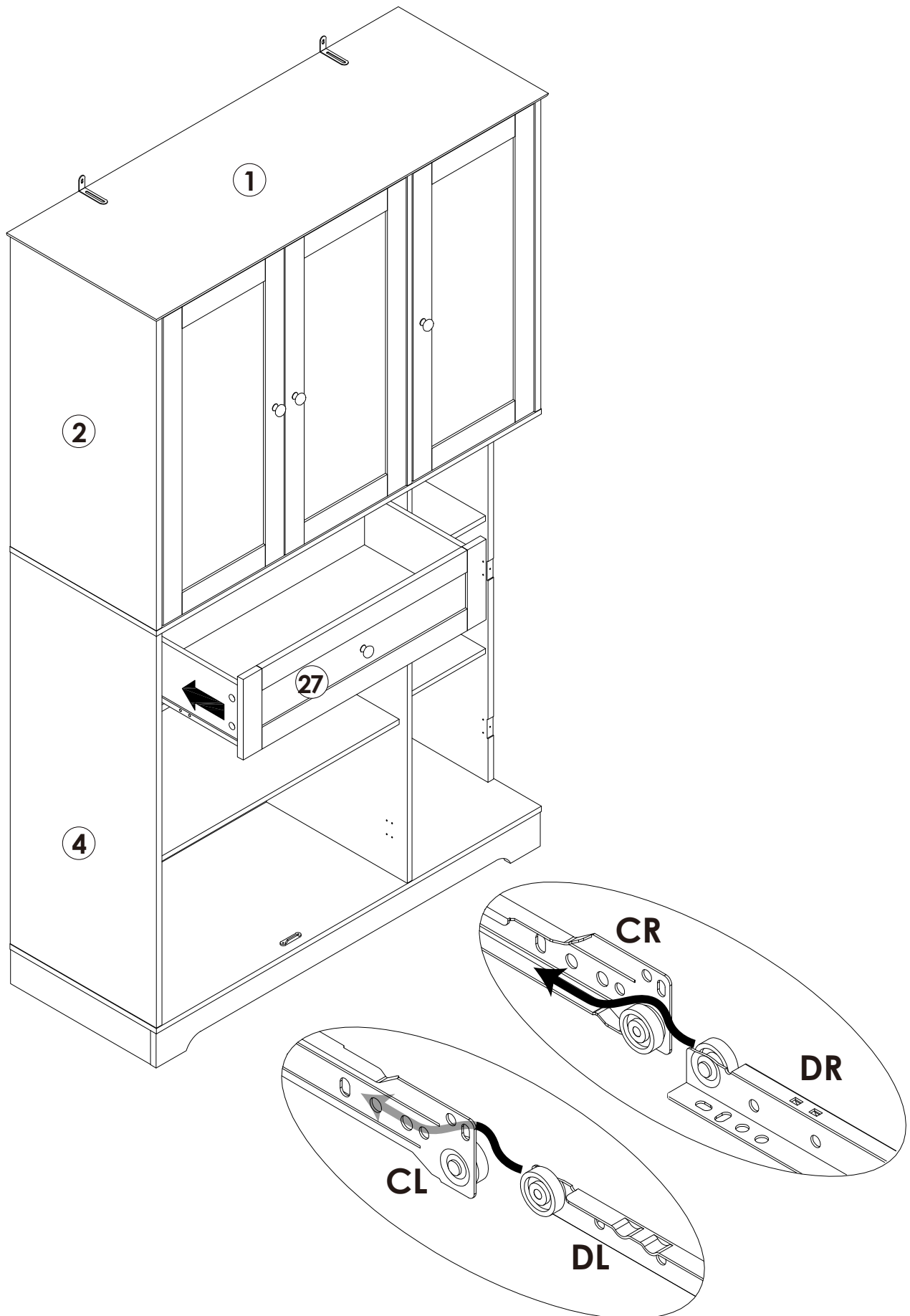

Assembly Steps(EN) / Montageschritte(DE)

STEP 35

When the hinges are installed, you can refer to the pictures to adjust crevice of the doors till it's perfect:

1. To adjust the doors up and down, please refer to step (a)
2. To adjust the distance between the doors and side panels, please refer to step (b)
3. To adjust the gap between two doors, please refer to step (c)
4. After the adjustment finished, please tight the screws, refer to step (d)

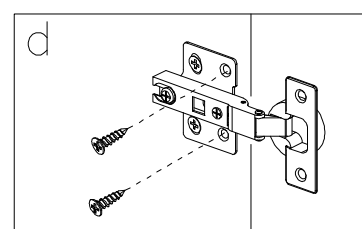
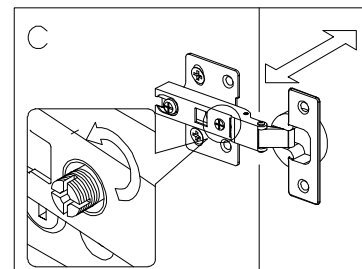
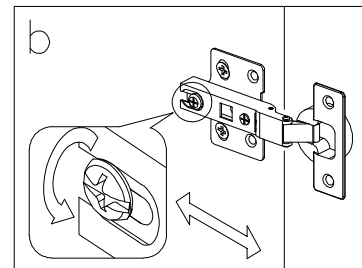
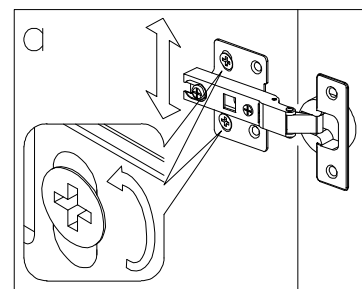
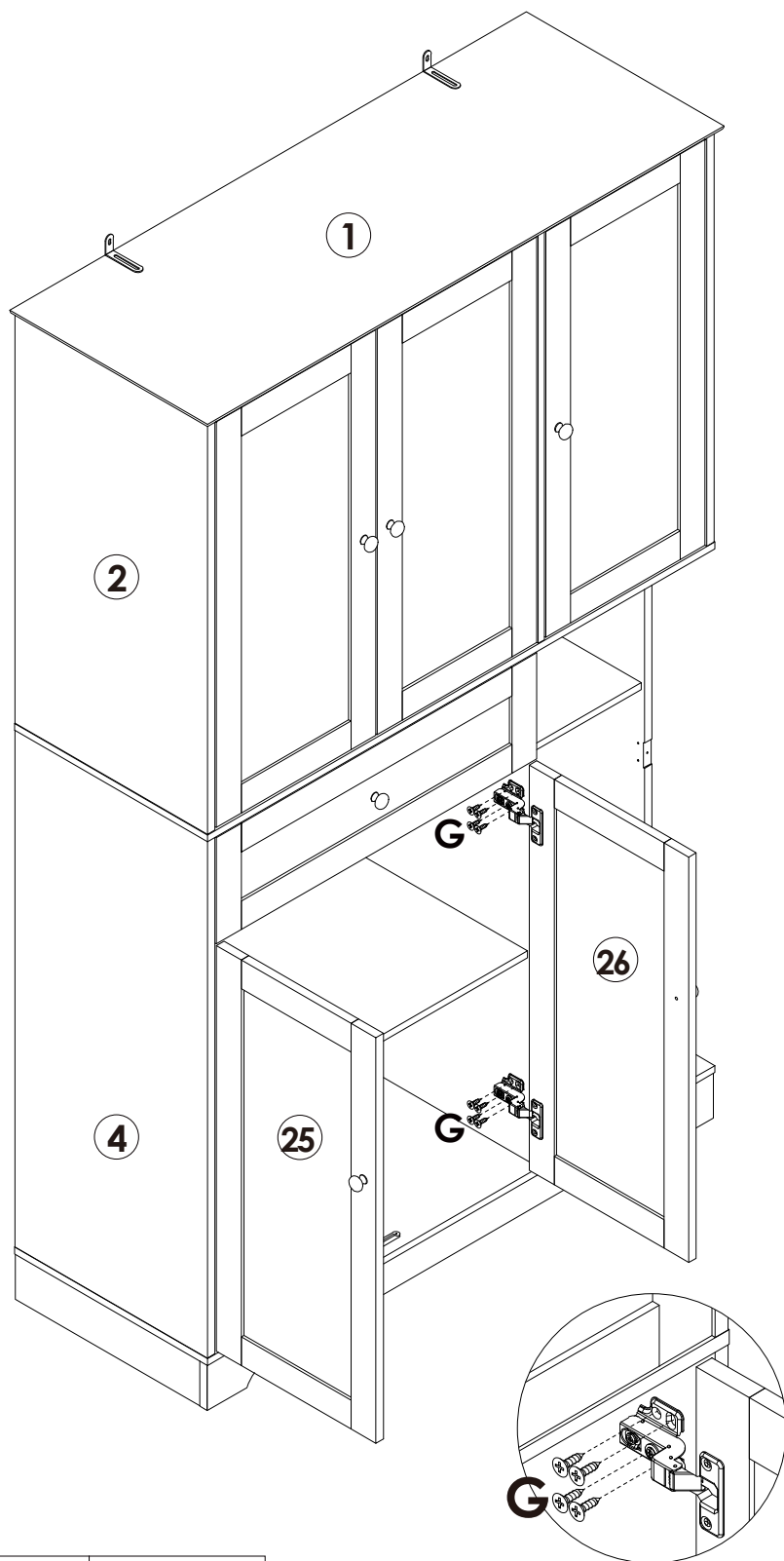

G x 16PCS



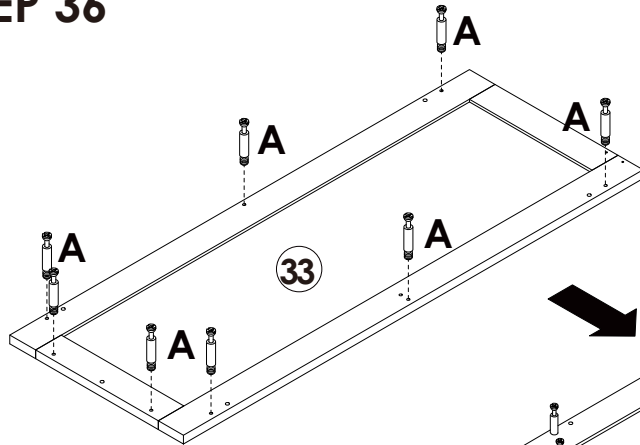

Assembly Steps(EN) / Montageschritte(DE)

STEP 36

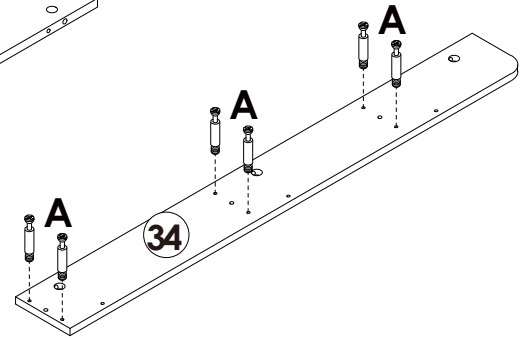
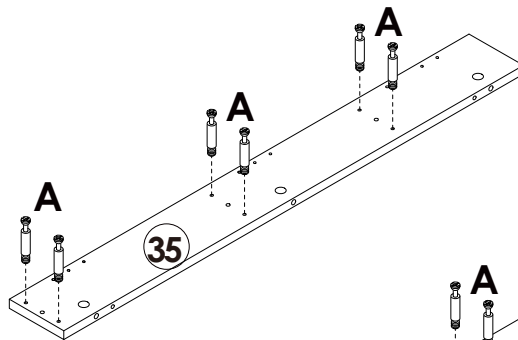
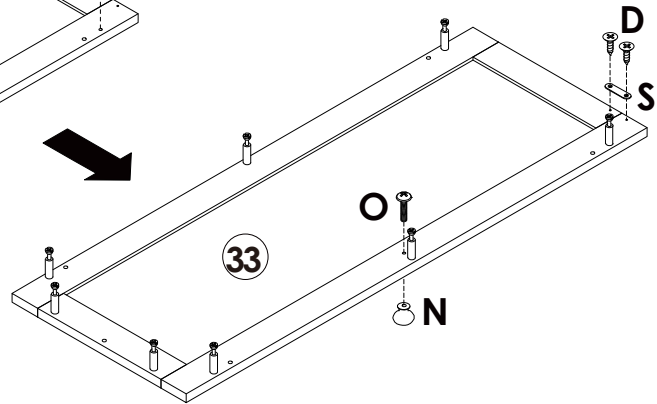

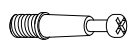

After tighten #A, please assemble the handle #O and #N.
(There is only one #33 board.)

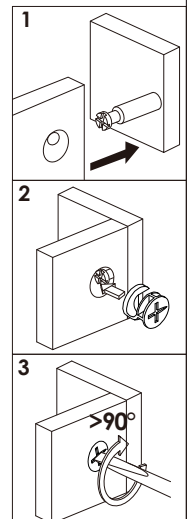
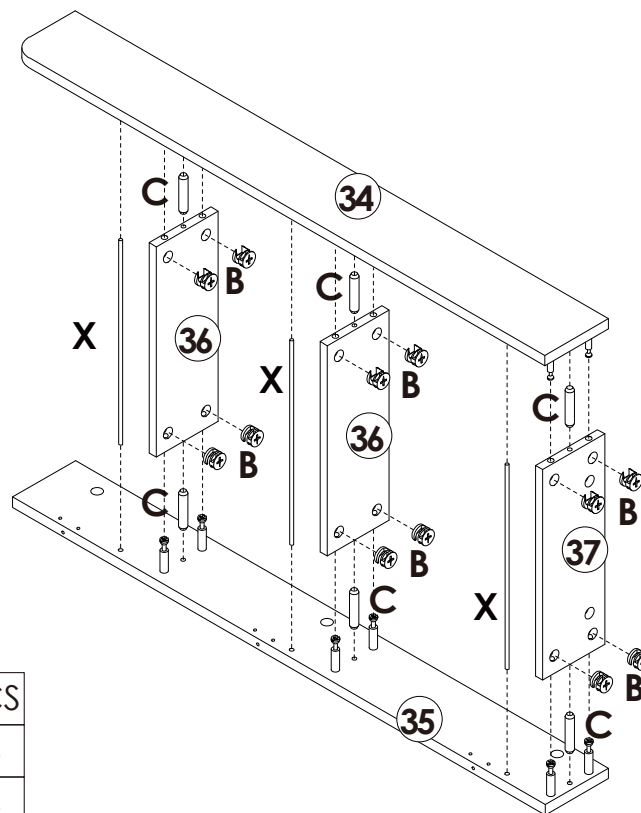

	A x 20PCS
	D x 2PCS
	S x 1PC
	N x 1PC
	O x 1PC

STEP 37





	B x 12PCS
	C x 6PCS
	X x 3PCS

Assembly Steps(EN) / Montageschritte(DE)

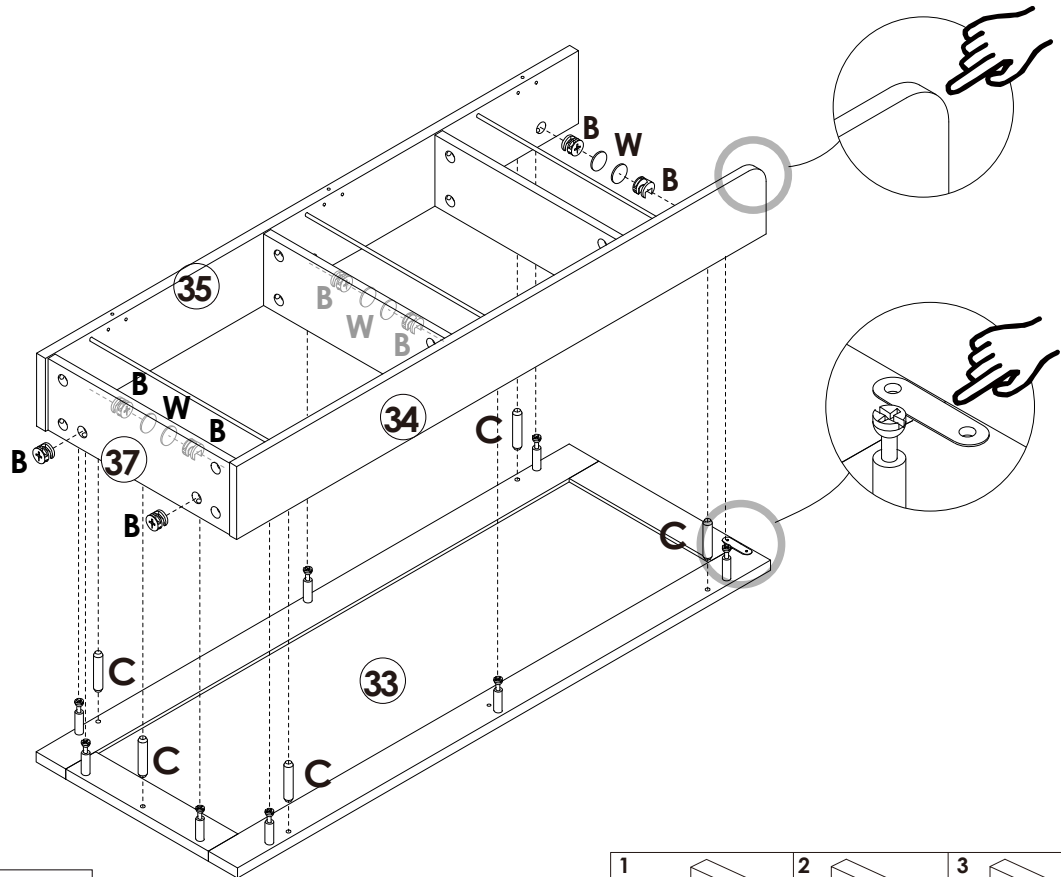
STEP 38

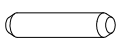

	B x 8PCS
	C x 5PCS
	W x 6PCS

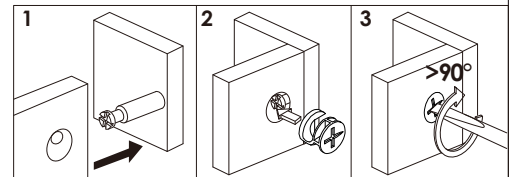

STEP 39

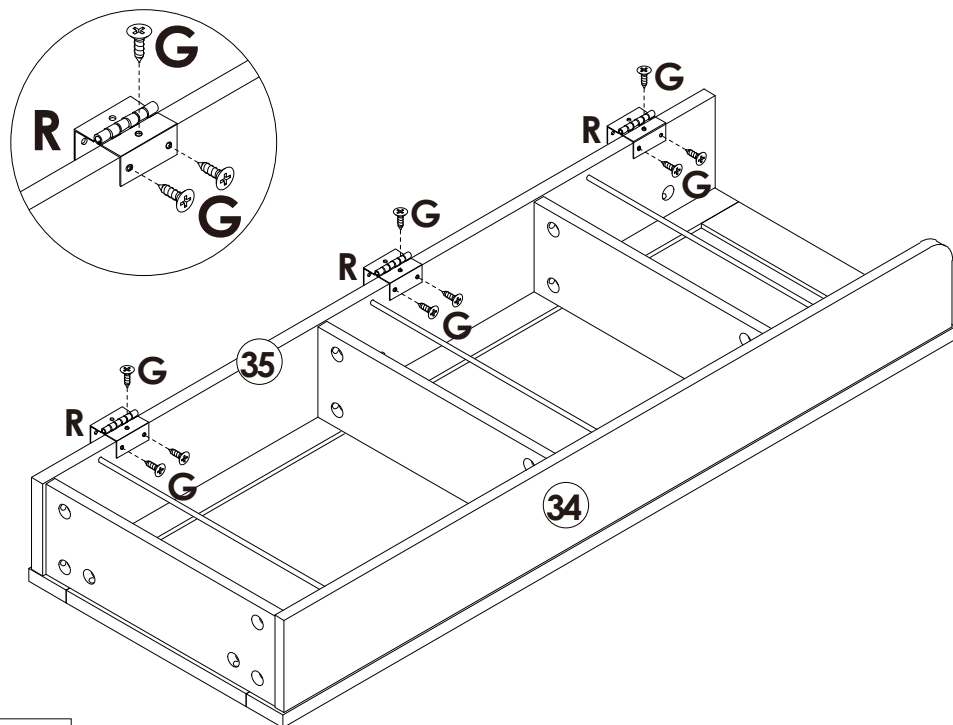

	G x 9PCS
	R x 3PCS

Assembly Steps(EN) / Montageschritte(DE)

STEP 40

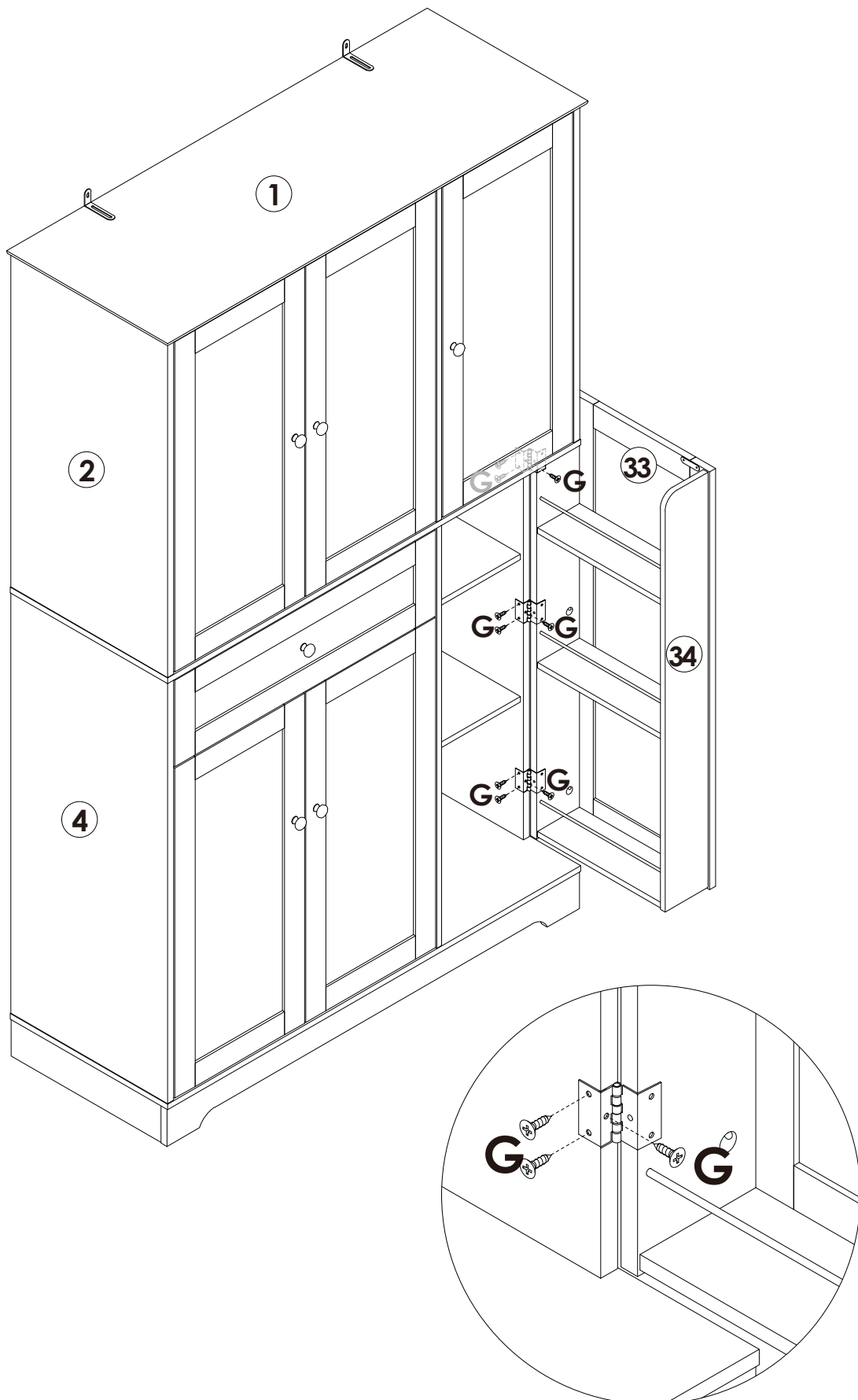

G x 9PCS

The ways to adjust the door

- Before adjusting the hinge, please check whether the cabinet is skewed.
- If the skew can not be repaired, please remove the anti-tipping device first, then adjust the cabinet to vertical position.
- Please adjust the hinge with the door open.
- Please operate it with more than 2 people, one person holds the door and the other one adjusts the screw.

Components Name

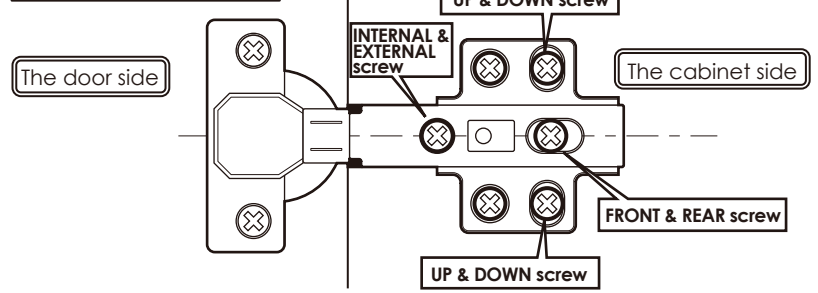

Obvious gaps between doors or Doors don't look closed

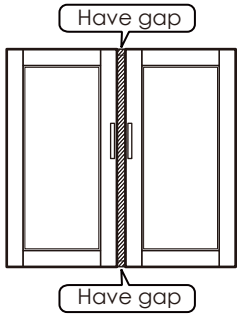

- 1 Turn "internal & external screw" to the right can make the door approach inside. Please adjust the doors little by little.

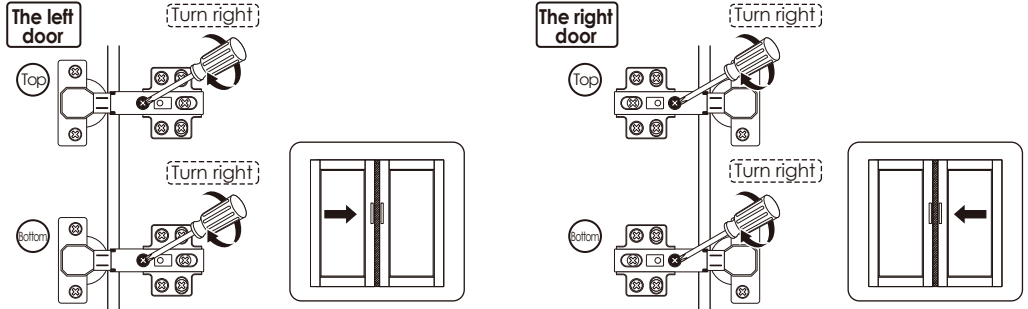

※ If the 2 doors are overlap, please turn the "internal & external screw" to the left.

When door is crooked



Please take the following steps to adjust first.

- 1 Rotate the "front and rear screws" to the left

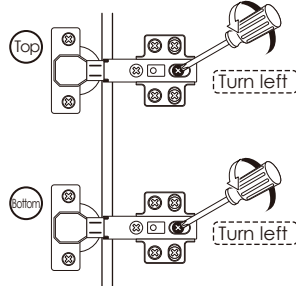

※ After adjusting the "front and rear screw", the door still does not change, please turn the "internal & external screw" to the right slightly.

- 2 Push the door to the cabinet

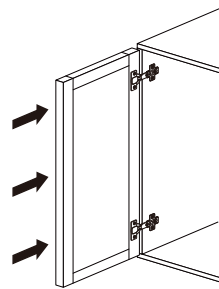

- 3 Rotate the "front and rear screws" to the right

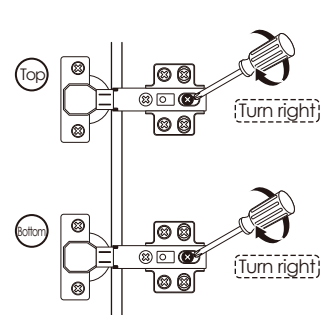

When door is leaning

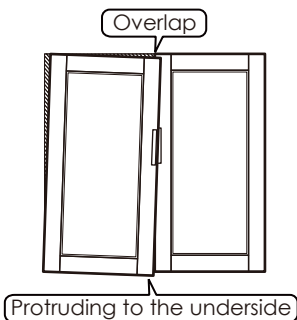

- 1 Turn "internal & external screw" to the left can make the top of the door tilted outward.

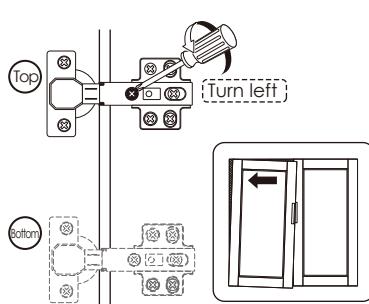

Protruding to the upside



- 1 Turn "internal & external screw" to the left can make the bottom of the door tilted outward.

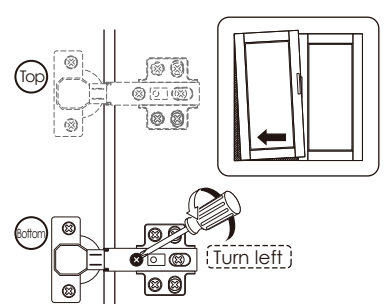

When the door is higher on top

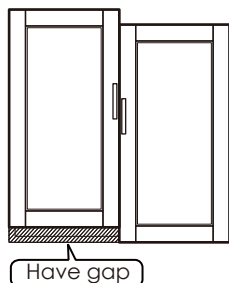

- 1 Turn "up & down screw" to the left

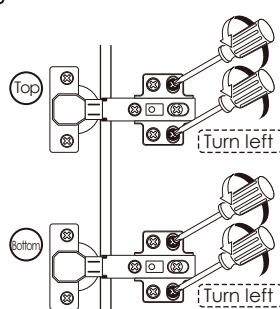

- 2 Lower the door's height so that 2 doors are of the same height.

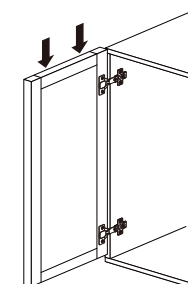

- 3 Turn "up & down screw" to the right

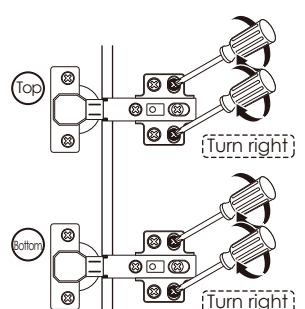

※ If the door is lower on bottom, please lift up the left door slightly on step 2



WARNING



Children have died from furniture tipover. To reduce the risk of furniture tipover:

- **ALWAYS** install Anti-tip device provided.
- **NEVER** put a TV on this product.
- **NEVER** allow children to stand, climb or hang on any drawers, doors, or shelves.
- **NEVER** open more than one drawer at a time.
- Place heaviest items in the lowest drawers.



***This is a permanent label.
Do not remove!***