

Assembly Instructions

Caution: You must read this before you proceed.

BISTRO TABLE



CAUTION: This table is NOT a TOY.
Keep your child / children at bay in the process of assembly.

Assembly Preparation

Before Beginning Assembly:

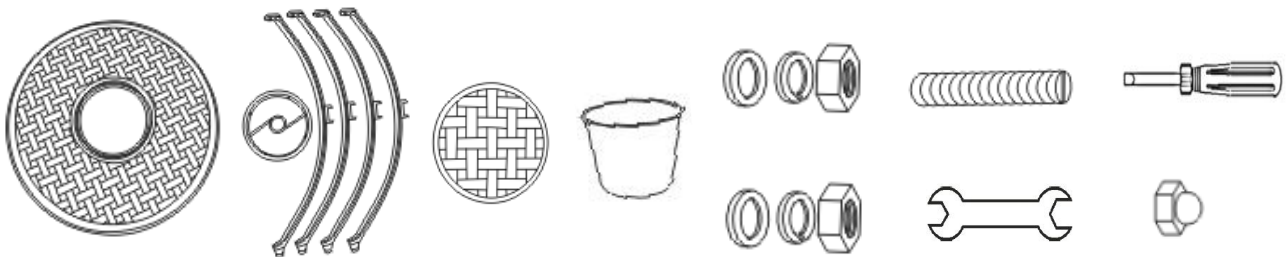

- Read instructions, cover to cover-



- Have 2 adults on hand for assembly-



- Do not assemble on flooring or carpet-







- Assemble on a clean non-marring surface (packing foam)-













- Save all packaging until finished-

Parts list

NO.	Picture	Description	QTY
A		Table Top	1
B		Table Leg with pre-attached Leveller	4
C		Central Round Support Ring	1
D		Cover	1
E		Ice Bucket	1

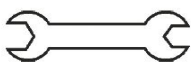
Hard ware

①		Washers(6mm)	9
		Spring washers(6mm)	9
		Nut(6mm)	9
②		Washers(8mm)	5
		Spring washers(8mm)	5
		Nut(8mm)	5
③		Plastic cap(6mm)	9
⑥		Stud(M8*40mm)	5
⑦		Spanner	1
⑧		Screwdriver	1

Assembly Step

OVERVIEW

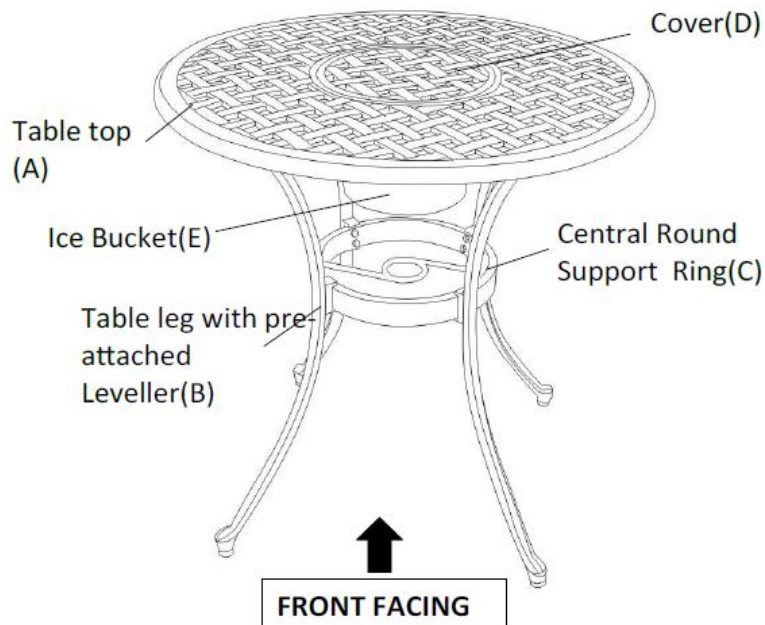

This Table has multiple parts and may require up to some 30 minutes to assemble.

To give you an overview of the Table parts, the above picture is to help you put the various parts into perspective.

Please read through the instructions below to familiarise yourself with the parts and steps before assembly.

Step 1

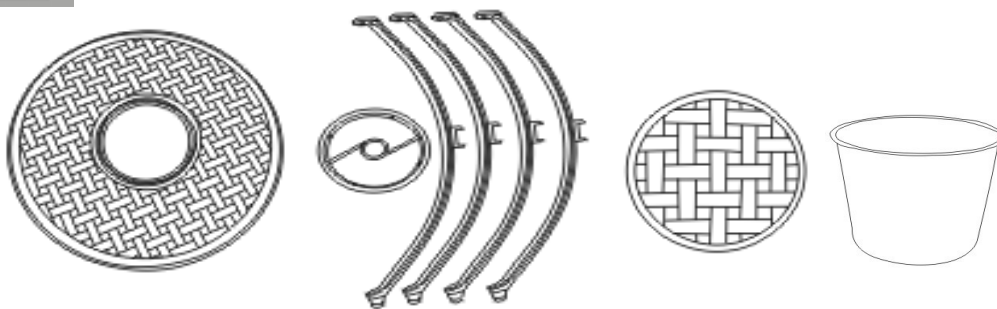

Unpack and place all parts on a clean soft surface.

Step 2

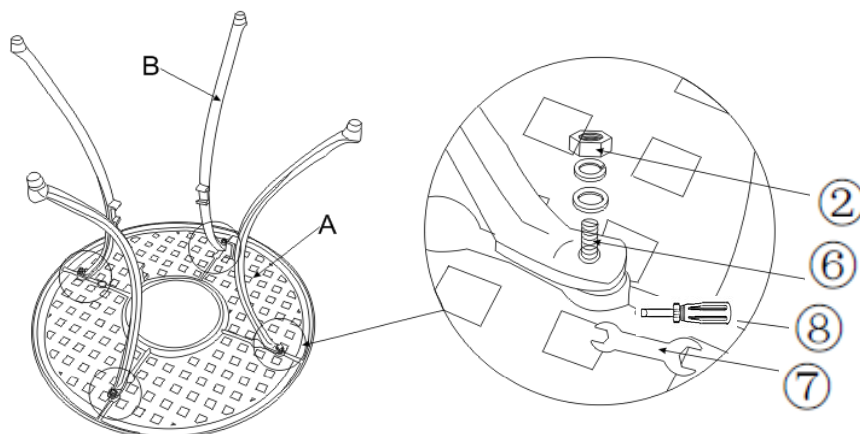

Lay the Table Top(A), Top being floor facing, onto a flat soft clean surface .
Turn in the Studs(⑥) to the specific mounting points on the underside of the
Table Top(A) with the Screwdriver(⑧).

Then place the Table Legs(B) to the these Stud points using Washers, Spring
Washers, and Nuts(②) with the Spanner(⑦).

DO NOT OVER TIGHTEN, yet.

Step 3

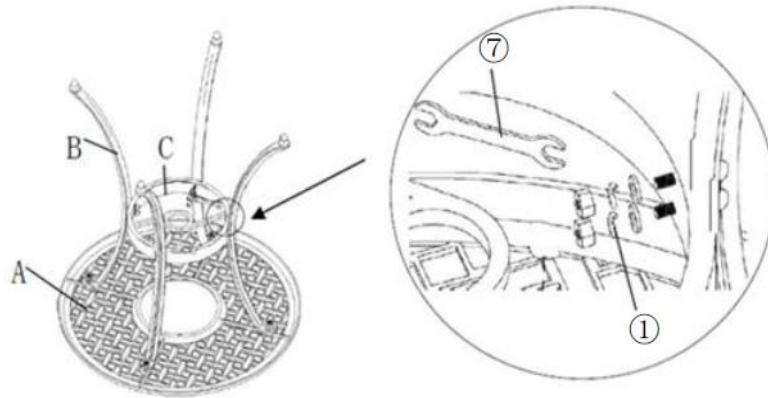

Attach the Central Round Support Ring (C) to Table Legs(B) using
Washers, Spring Washers, and Nuts (①) with the Spanner (⑦).

Repeat the same tightening at all 4 points of the Legs.

DO NOT OVER TIGHTEN, yet.

Step 4

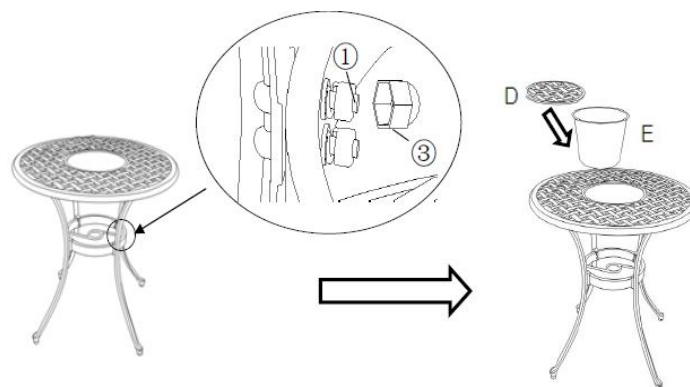

Turn the Table rightside up.

Proceed to tighten all Bolts and Nuts.

Add the Plastic cap(③) to the bolts end (①).

Put the Ice Bucket(E) into the middle housing of the Table top(A).

Put the Cover(D) over the Ice Bucket (E).

Step 5











Adjust height for
balance

Adjust low for
balance

Adjust Pre-installed
Levellers
height for balance

Adjust the pre-installed Leveller until the Table is level with the ground.

Care & Maintenance

- ⊘  • Do not put hot items directly on furniture surface.
 - ⊘  • Do not clean furniture with harsh cleansers or polish.
 - ✓  • To obtain the longest lifespan of your outdoor products, minimizing exposure to direct sunlight is recommended.
 - ⊘  • Children should not climb or jump on the furniture.
 - ⊘  • Do not write on furniture without a padded barrier to protect the surface.
 - ✓  • To obtain the longest lifespan of your outdoor products, avoid extended and lengthy exposure to rain, snow, and direct sunshine. Whenever possible cover the product and /or place under patio or awnings.
 - ⊘  • Not for commercial use. For residential use only .
 - ⊘  • Stains may be removed with mild soap solution and damp cloth.
-
- ✓  • Dust and pick-up spills using a clean, non-colored, lint-free cloth .