



ASSEMBLY INSTRUCTIONS
COASTER FINE FURNITURE



Fine Furniture for every stage of life

115231
DINING TABLE

ITEM: **115231**



ASSEMBLY INSTRUCTIONS

ASSEMBLY TIPS:

1. Remove hardware from box and sort by size.
2. Please check to see that all hardware and parts are present prior to start of assembly.
3. Please follow attached instructions in the same sequence as numbered to assure fast & easy assembly.



WARNING!

1. Don't attempt to repair or modify parts that are broken or defective. Please contact the store immediately.
2. This product is for home use only and not intended for commercial establishments.



ASSEMBLY TIME

10 MINUTES

PARTS IDENTIFICATION

A TOP 1PC

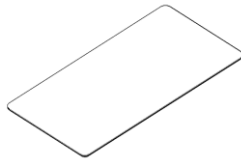

B FRAME 1PC

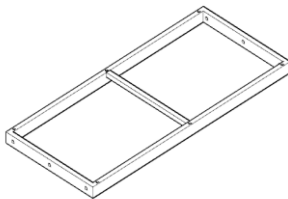

C LEG 2PC

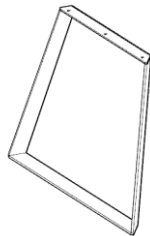

NOTE:

Phillips head screw driver is required in the assembly process; however, manufacturer does not provide this item.

ITEM:115231



ASSEMBLY INSTRUCTIONS

ASSEMBLY TIPS:

1. Remove hardware from box and sort by size.
2. Please check to see that all hardware and parts are present prior to start of assembly.
3. Please follow attached instructions in the same sequence as numbered to assure fast & easy assembly.



WARNING!







1. Don't attempt to repair or modify parts that are broken or defective. Please contact the store immediately.
2. This product is for home use only and not intended for commercial establishments.



ASSEMBLY TIME

10 MINUTES

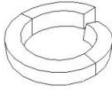
HARDWARE IDENTIFICATION

| | | | |
|---|--|---|-------|
| 1 | ALLEN KEY (5MM) |  | 1PC |
| 2 | FLAT WASHER ($\phi 8 \times 20 \times 1.2$) |  | 12PCS |
| 3 | ALLEN SCREW (M8*20) |  | 6PCS |
| 4 | ALLEN SCREW (M8*30) |  | 6PCS |
| 5 | SPRING WASHER ($\Phi 8.5 \times 1.5$) |  | 6PCS |
| 6 | STICKER (50*50*2) |  | 8PCS |

NOTE:

Phillips head screw driver is required in the assembly process; however, manufacturer does not provide this item.

ITEM: **115231**

ASSEMBLY INSTRUCTIONS



STEP:1

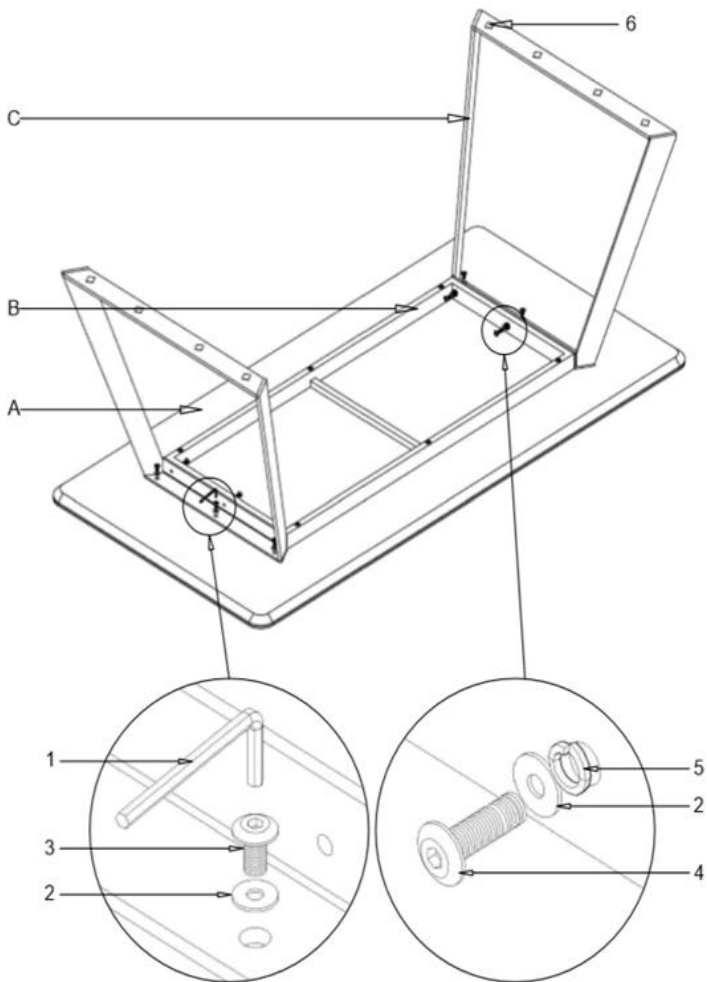

COMPLETE

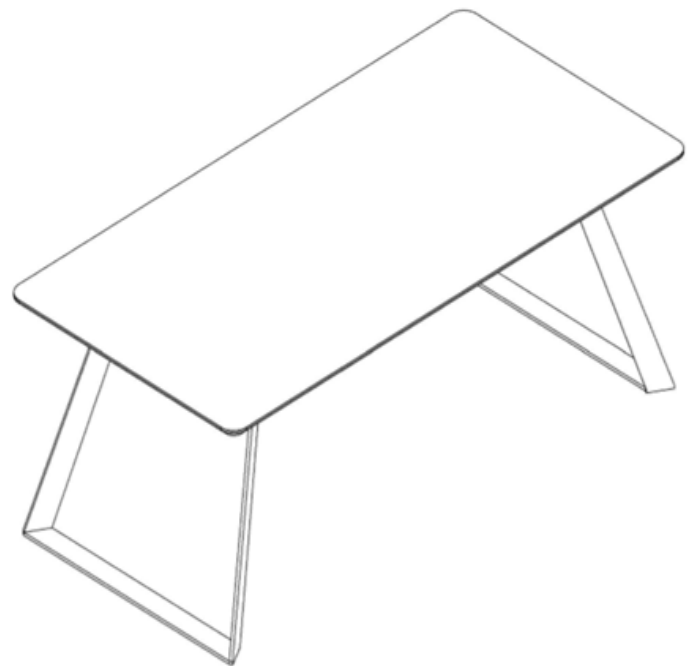

ITEM: **115231**

ASSEMBLY INSTRUCTIONS

