

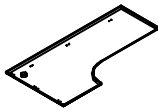

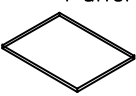

(1) Top  1PC	(2) End Panel  1PC	(3) End Panel  1PC	(4) Modesty Panel  1PC	(A) Dowel  12PCS+1	(B) Cam Pin  11PCS+1	(C) Cam Lock  11PCS+1	(p) Adhesive Cam Cover  11PCS+1	(D) Leg leveller  4PCS	(W) Grommet  1PC	STEP 3
---	---	---	---	---	--	--	--	---	---	--------

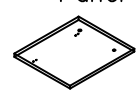
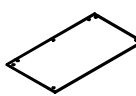
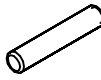
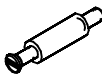

RIGHT CORNER CREDENZA

72" W\*24/36" D\*29" H

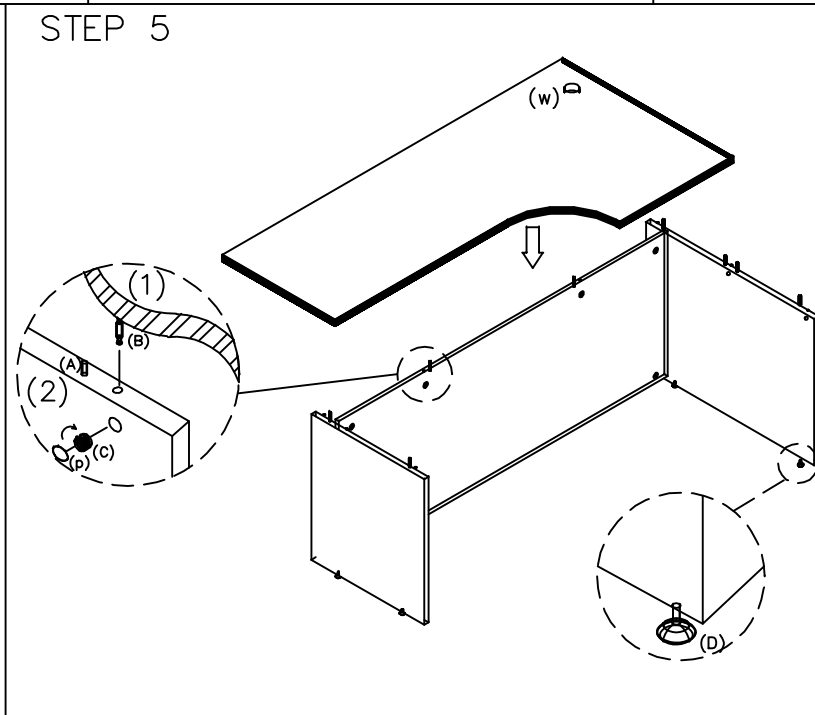
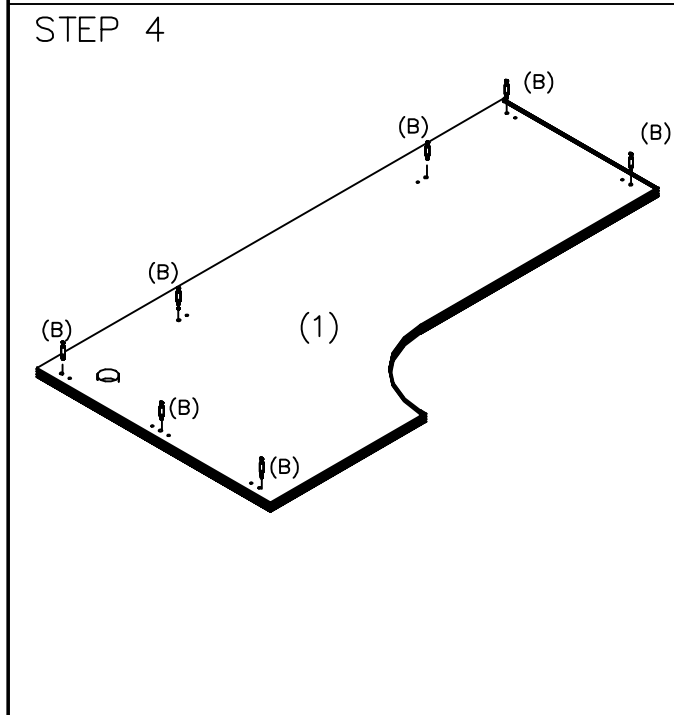
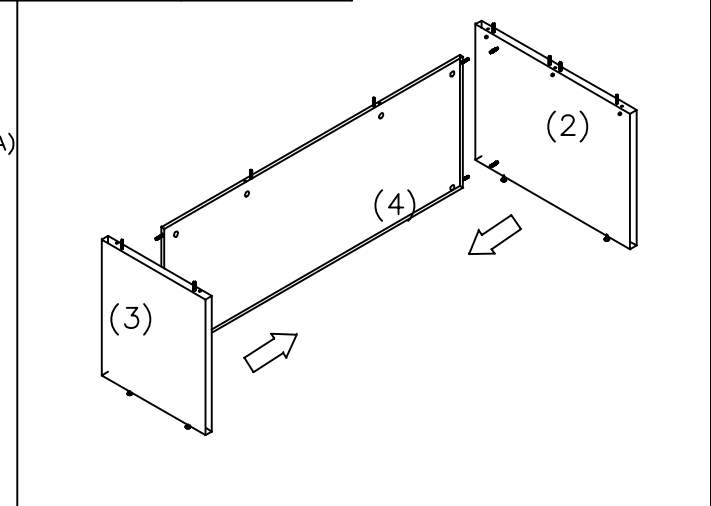
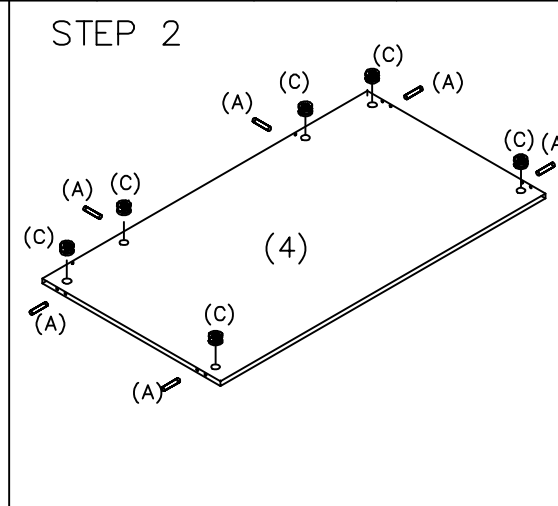
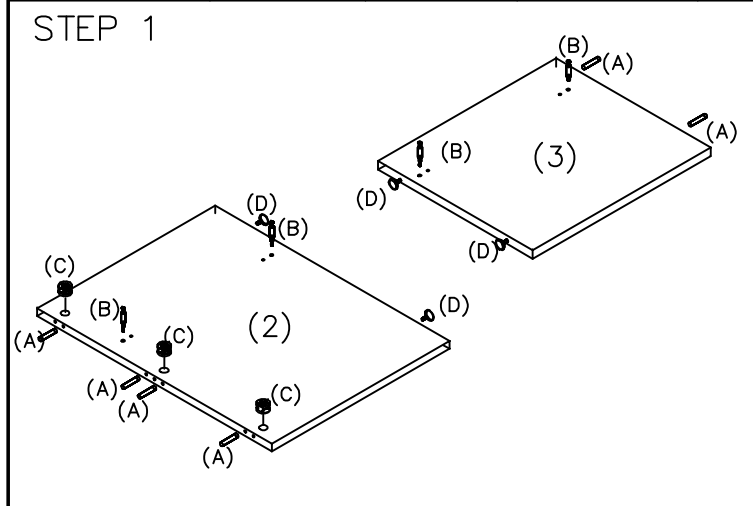
*Always lay components on A clean, soft-cushioned surface during assembly.*