



Assembly instructions for the sofa, including warnings, time, and person requirements.

Warning 1: Do not use a power drill. Use an Allen key (shown in a circle) to tighten the screws. 



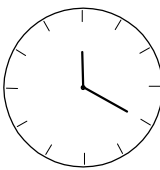
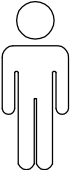

Warning 2: Do not place the sofa on a soft surface like a rug. Place it on a hard, flat surface. 

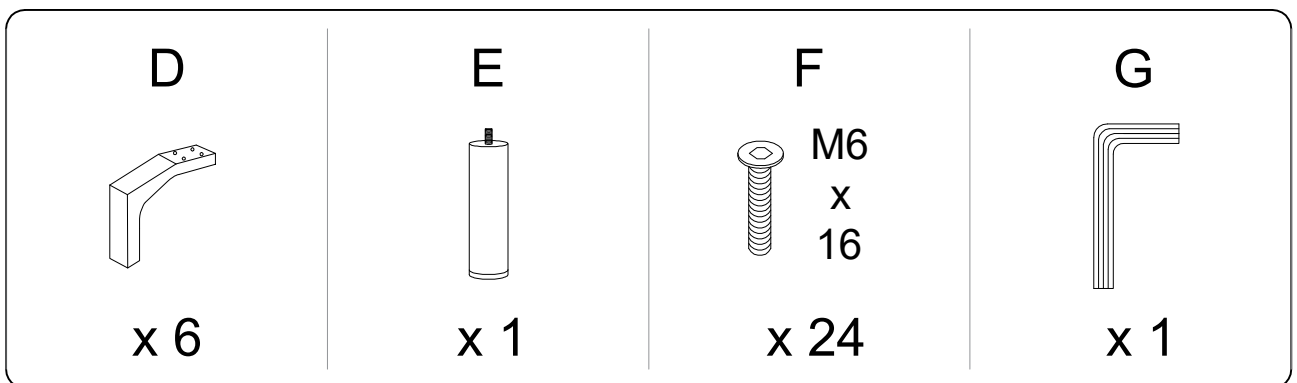
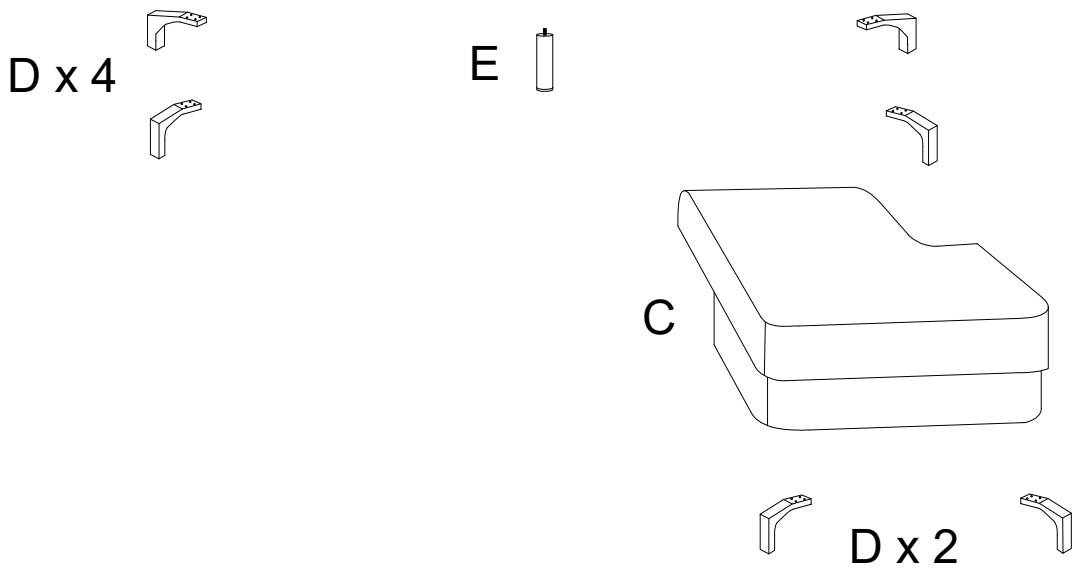
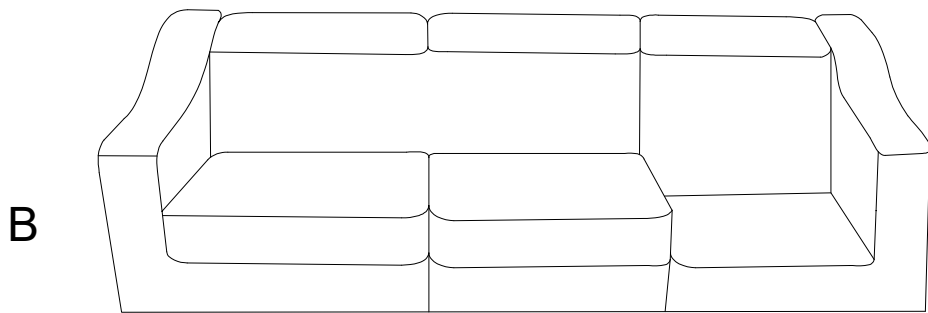
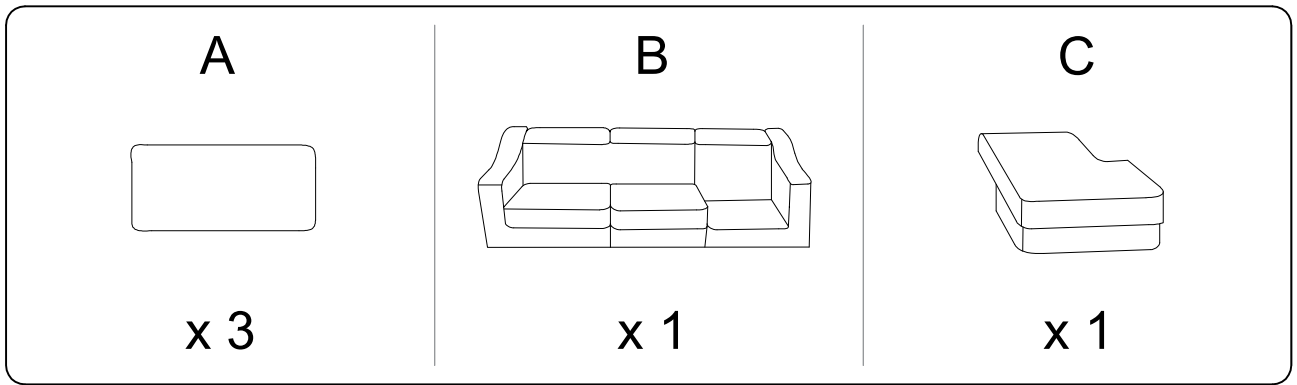
Time: 20' 

Personnel: 2 

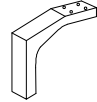

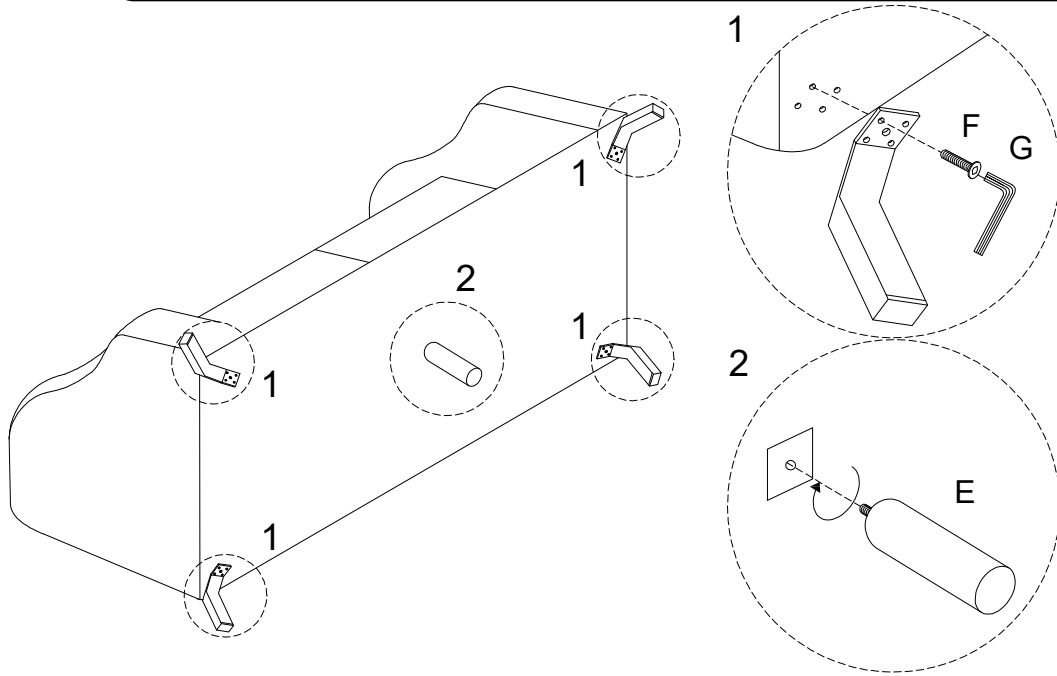

1

B  x 1	D  x 4	E  x 1	F M6 x 16  x 16	G  x 1
--	--	--	--	--

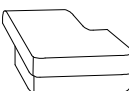
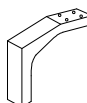

2

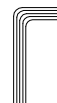
C  x 1	D  x 2	F M6 x 16  x 8	G  x 1
--	--	---	--

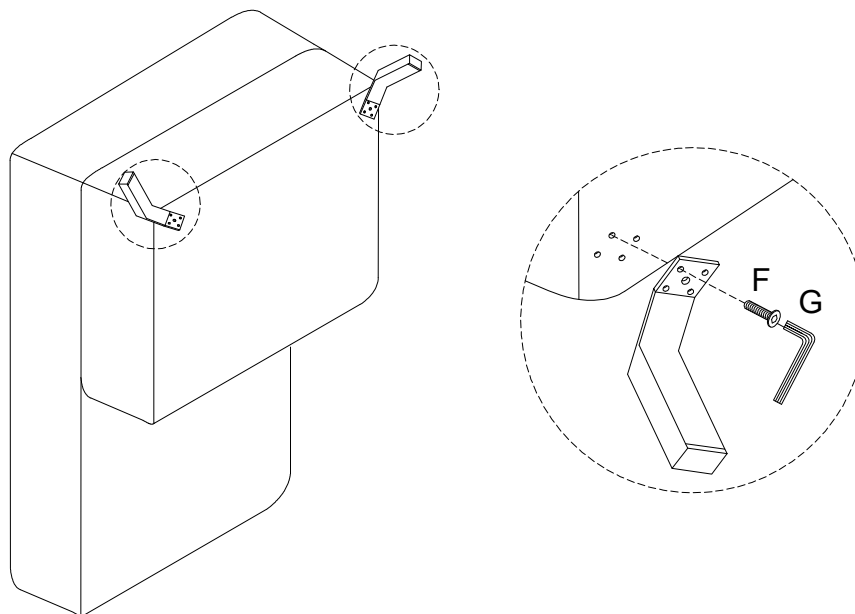

!

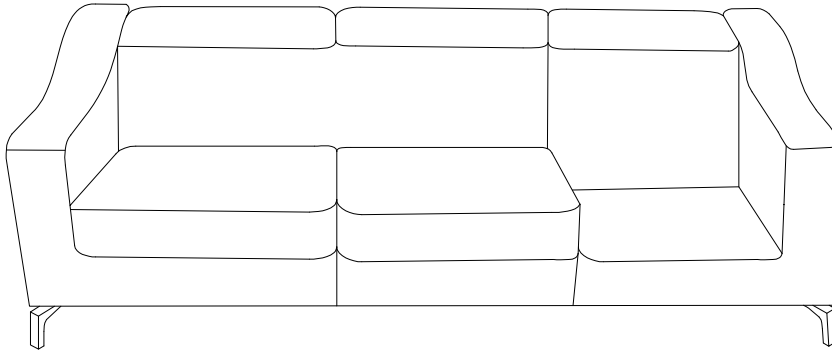
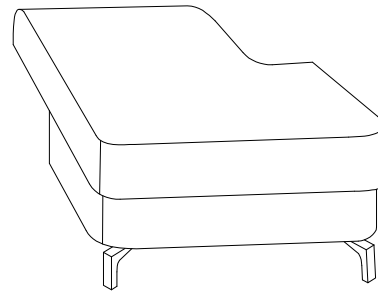

3

A



x 3

