

SKU:H00032

THE BED ASSEMBLY INSTRUCTIONS

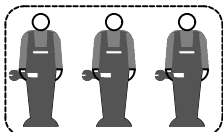
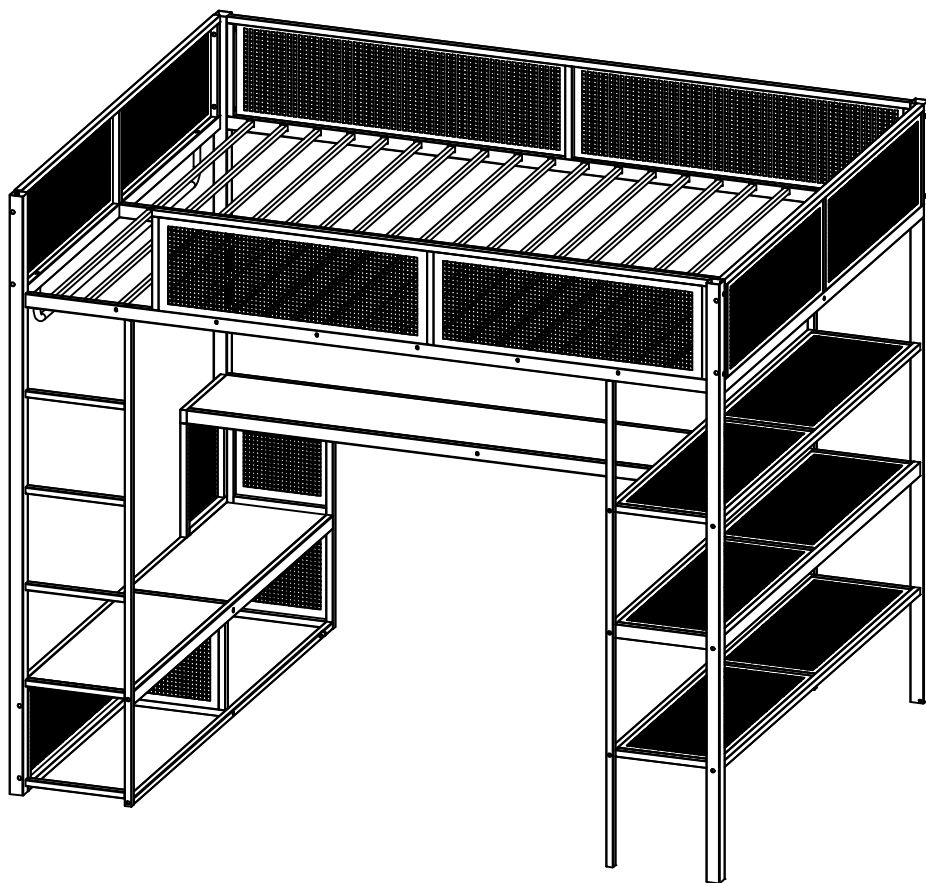

SAFETY WARNINGS AND GENERAL NOTES:

1. Follow the information on the warnings on the bunk bed end structure and on the carton. Do not remove the warning label from the bed.
2. Always use the recommended size mattress on mattress support, or both, to help prevent the likelihood of entrapment or falls.
3. Do not allow children under 6 years of age to use the upper bunk.
4. Periodically check and ensure the guardrail, ladder and other components are in their proper position, free from damage, and all connectors are tight.
5. Do not allow horseplay on or under beds.
6. Always prohibit jumping on the bed.
7. Prohibit more than one person on upper bunk.
8. Always use the ladder for entering and leaving the upper bunk.
9. Do not use substitute parts. Contact the manufacturer or dealer for replacement parts.
10. Use of a night-tight may provide added safety precaution for a child using the upper bunk.
11. Always use guardrails on both long sides of the upper bunk.
12. If the bunk bed will be placed next to a wall, the guardrail that runs the full length of the bed should be placed against the wall to prevent entrapment between the bed and the wall.
The use of water or sleep flotation mattresses is prohibited.
13. **STRANGULATION HAZARD**-Never attach or hang items to any part of the bunk bed that are not designed for use with the bed; for example, but not limited to, hooks, belts and jump ropes.
14. Keep these instructions for future reference.
15. We recommend assembling your bunk bed on the shipping carton to protect your floor or carpet.
16. Be certain all staples are out of the box before beginning assembly on the shipping carton.
17. **USE ONLY MATTRESSES WHICH ARE AS THE TABLE BELOW ON UPPER AND ON LOWER BUNKS.**

Up bed				
Mattress type	Length	Width	Thickness	
Queen Standard	79"-80"	59"-60"	6"Max	

18. SURFACE OF MATTRESS MUST BE AT LEAST 5"(127MM) BELOW THE UPPER EDGE OF GUARDRAILS.







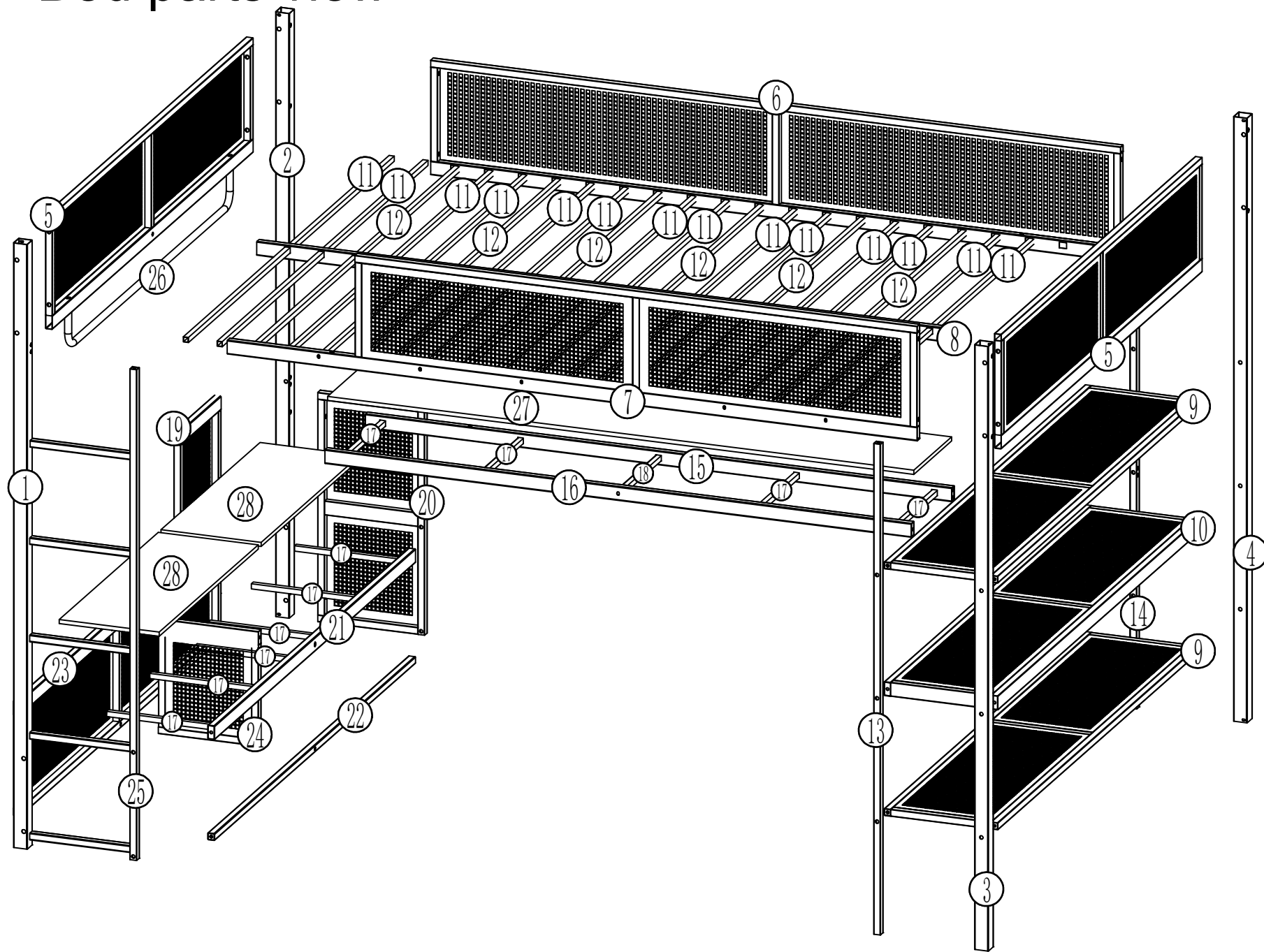



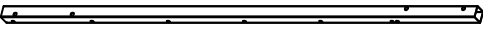
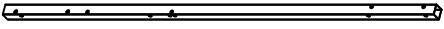
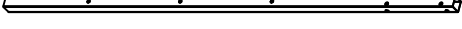
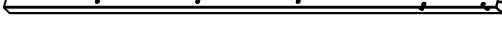
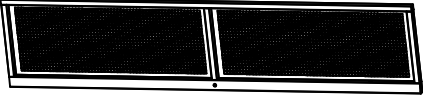
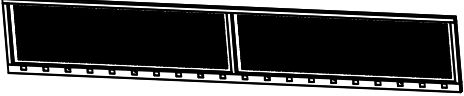
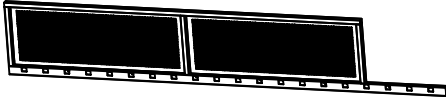

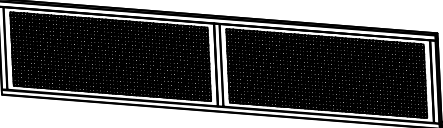
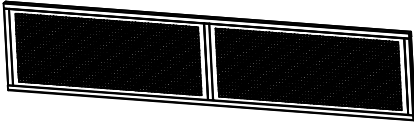

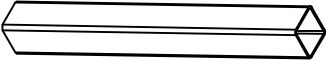
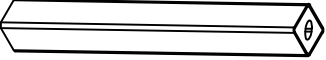

19. Replacement Parts:

Replacement Parts, including additional guardrails, may be obtained from any of our (Shenzhen Yuefeng Zhiqi Technology Co.,Ltd) dealers.

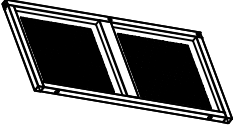

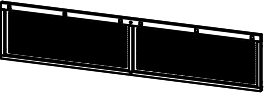
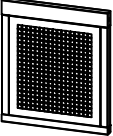

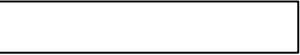

Bed parts view



Bed parts view



 #1--1PCS	 #2--1PCS	 #3--1PCS	 #4--1PCS		
 #5--2PCS	 #6--1PCS	 #7--1PCS	 #8--1PCS		
 #9--2PCS	 #10--1PCS	 #11--14PCS	 #12--6PCS		
 #13--1PCS	 #14--1PCS	 #15--1PCS	 #16--1PCS		
 #17--10PCS	 #18--1PCS	 #19--1PCS	 #20--1PCS	 #21--1PCS	 #22--1PCS
 #23--1PCS	 #24--1PCS	 #25--1PCS	 #26--1PCS	 #27--1PCS	 #28--2PCS

Hardware List

 C-M8*35 20PCS	 D-M8*55 43PCS	 E-M6*25 14PCS	 F-M8*15 20PCS	 K-40PCS	 O-1PCS	 L
---	---	---	---	--	---	--

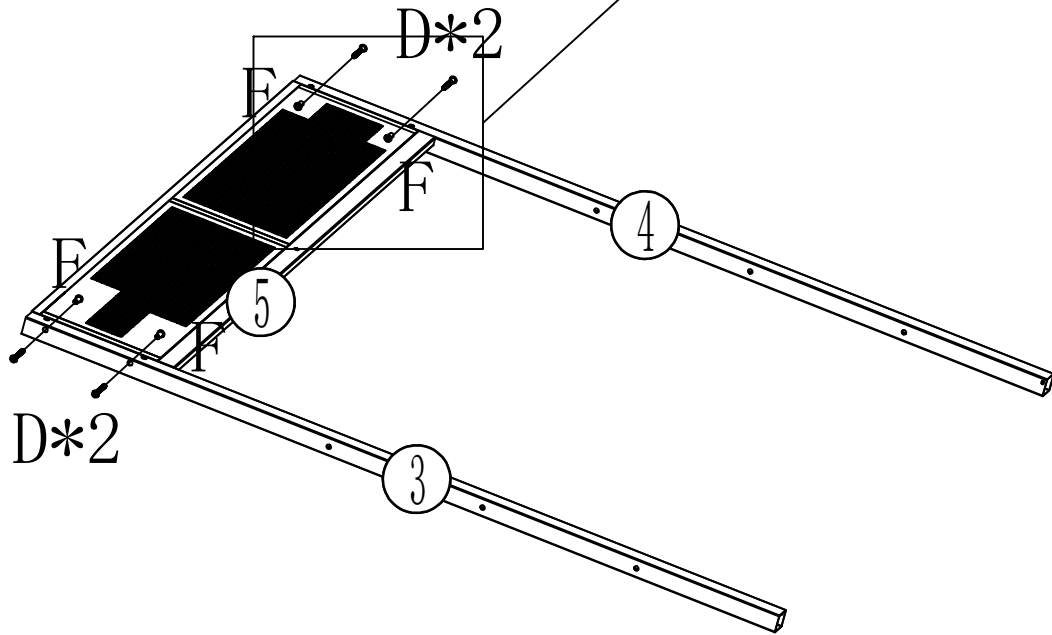
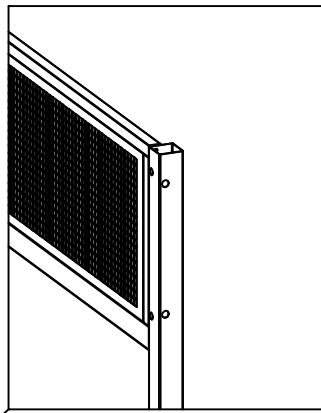
Step 1:





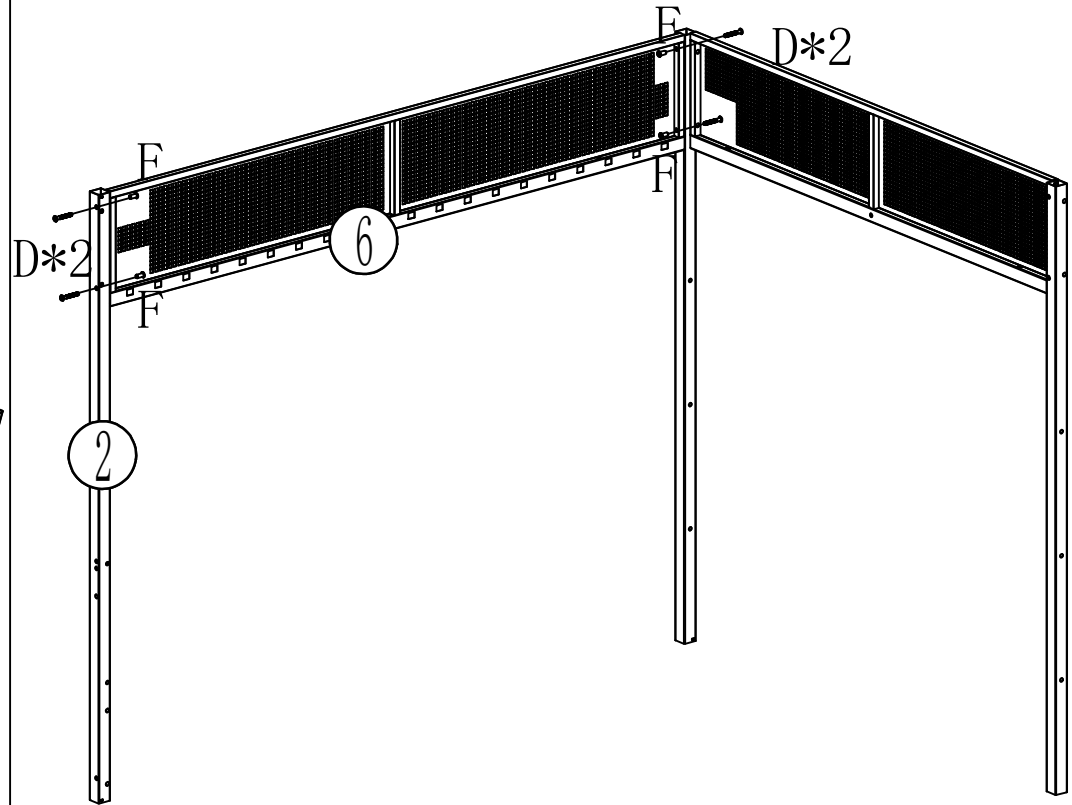
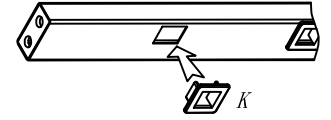

		
F 8*15-4PCS	D 8*55-4PCS	L

Step 2:

Please install part K onto number 6 before installing the number 6 assembly.



			
K-20PCS	F 8*15-4PCS	D 8*55-4PCS	L

Step 3:

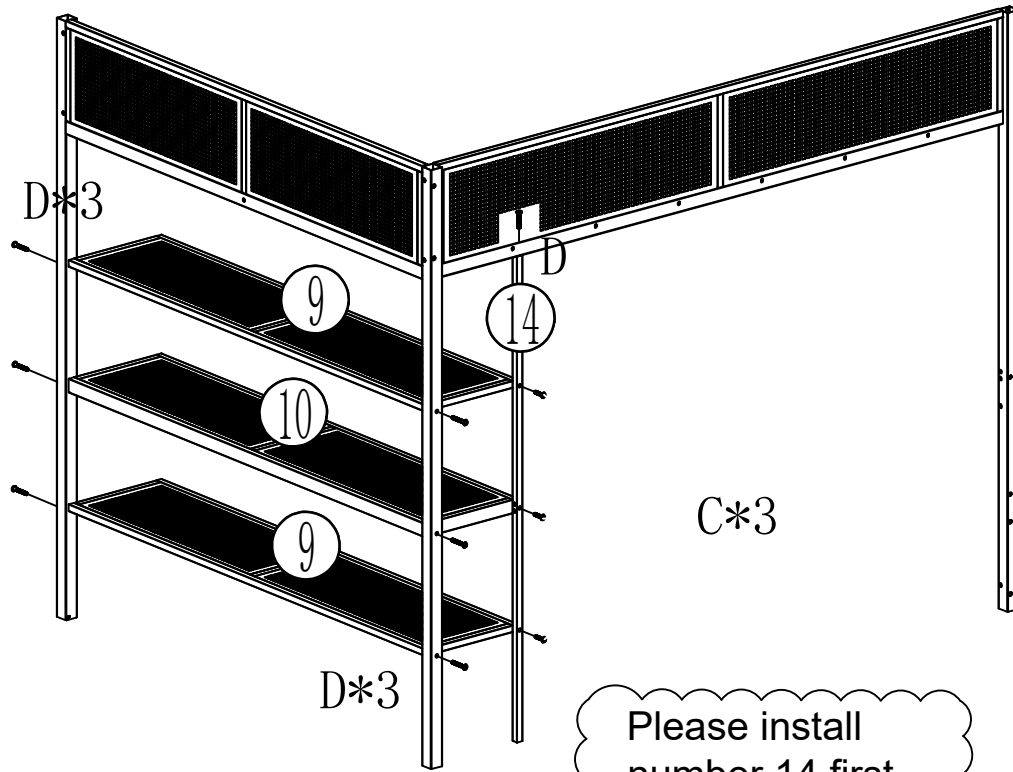

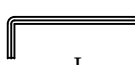

Please install number 14 first.

		
C 8*35-3PCS	D 8*55-7PCS	L

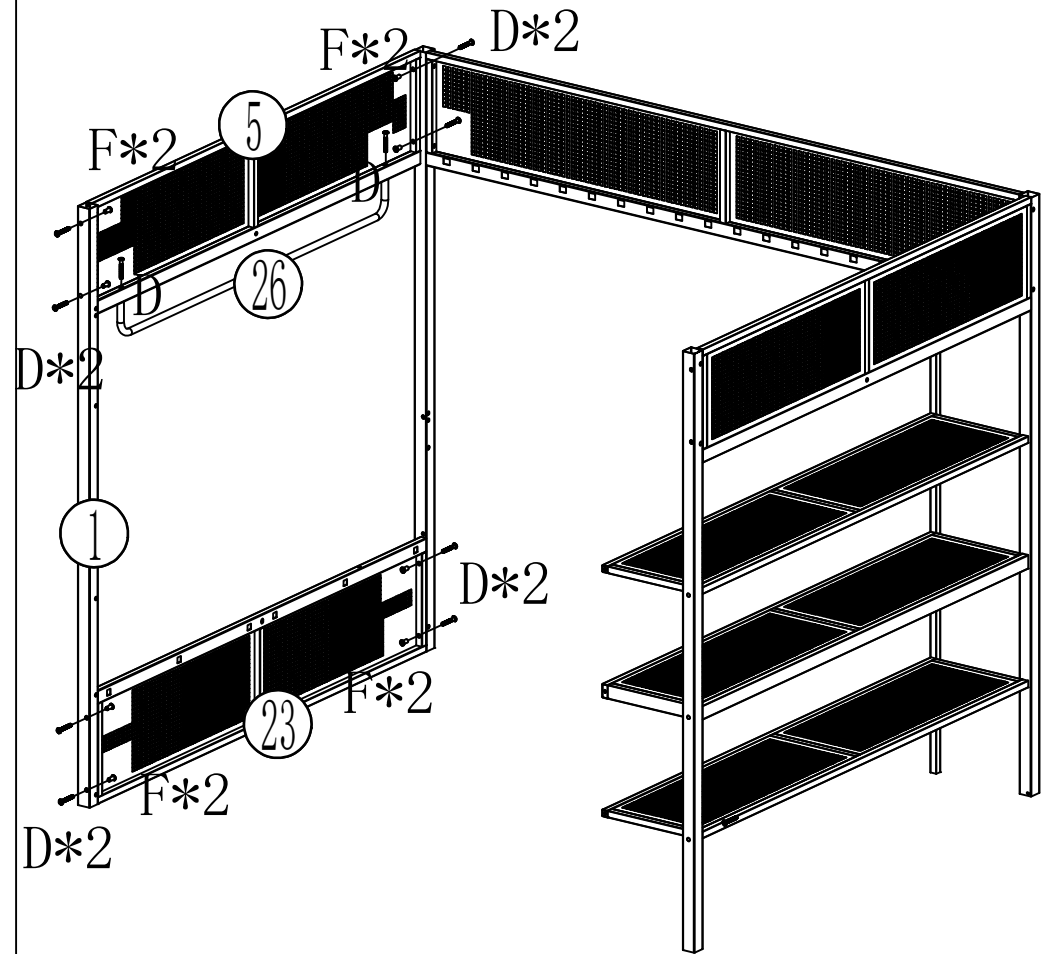

Step 4:

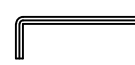

		
F 8*15-8PCS	D 8*55-10PCS	L

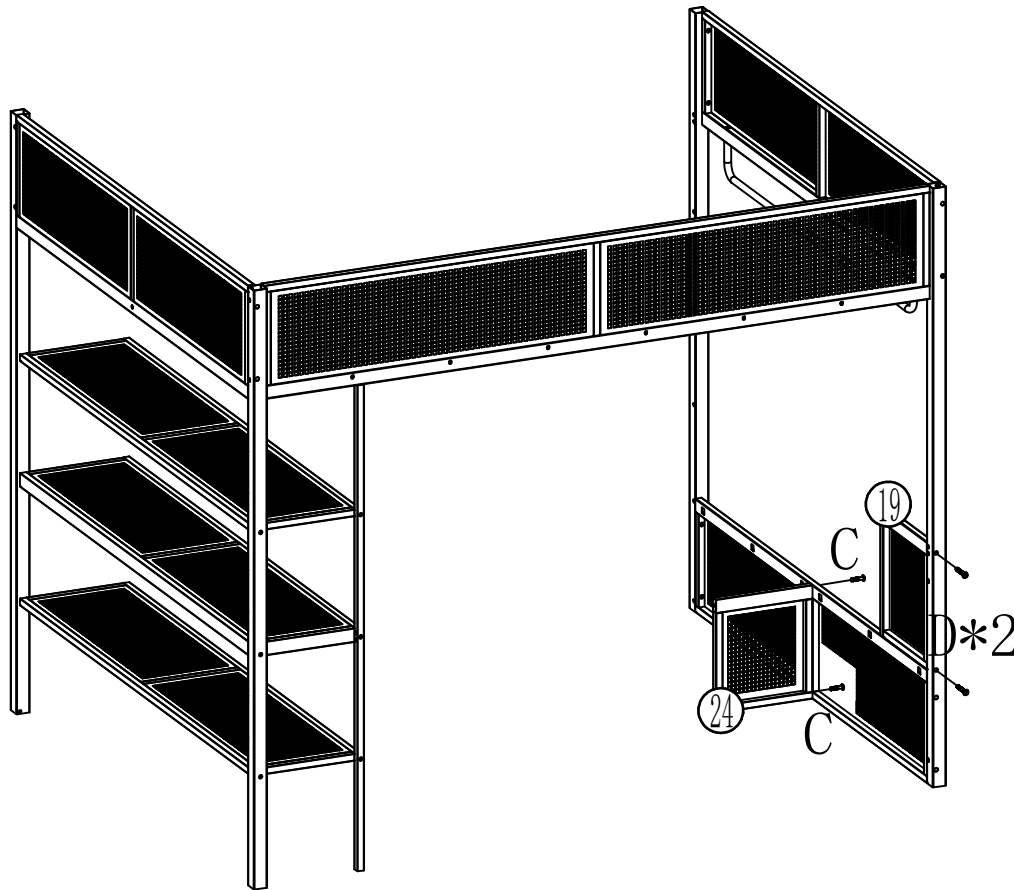



Step 5:

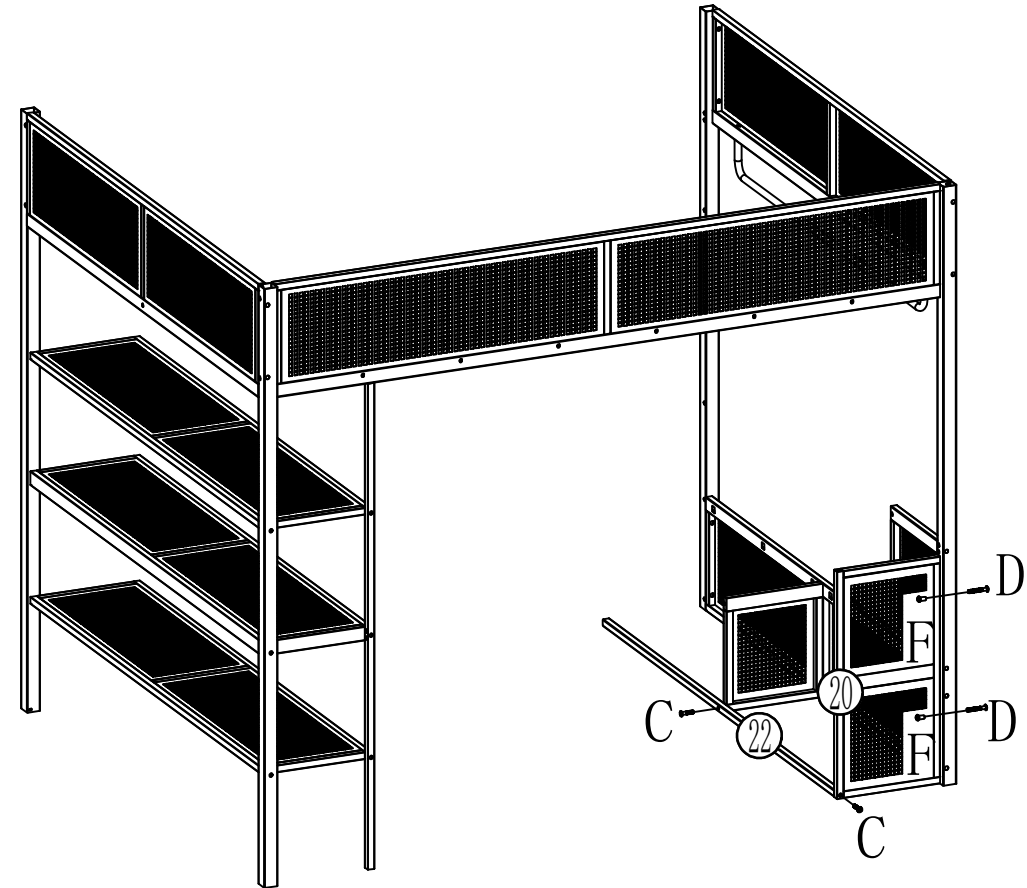

		
C	D	L
8*35-2PCS	8*55-2PCS	

Step 6:



			
C	F	D	L
8*35-2PCS	8*15-2PCS	8*55-2PCS	



Step 7:



Attention

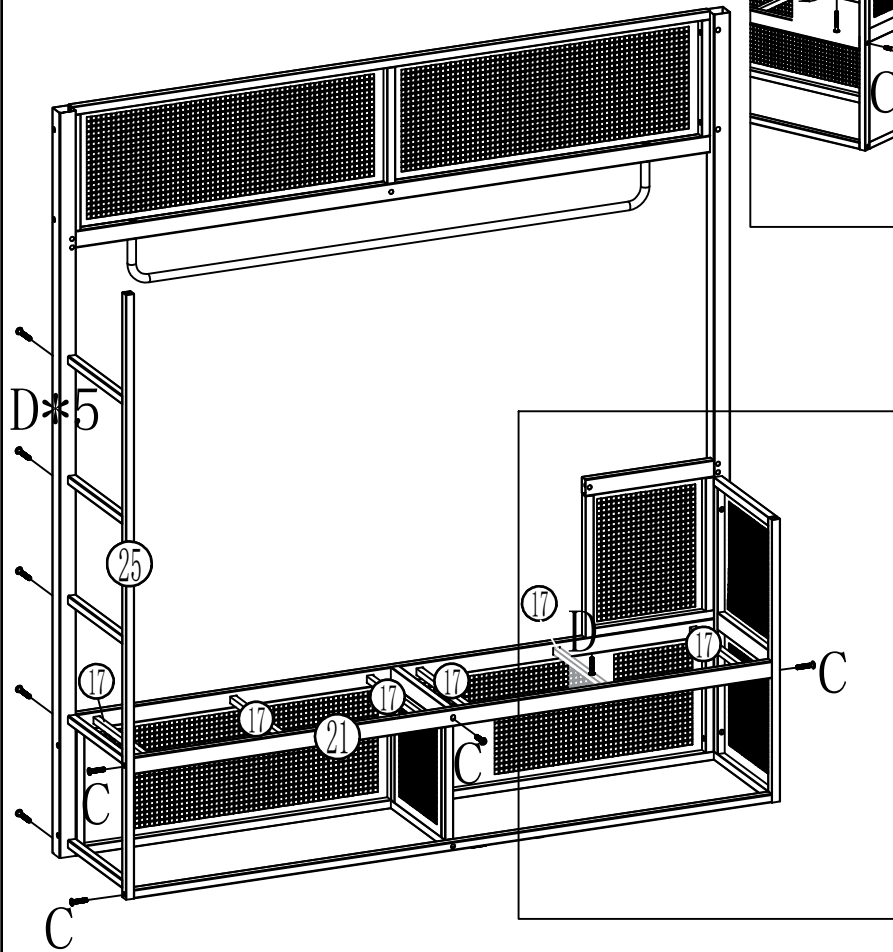
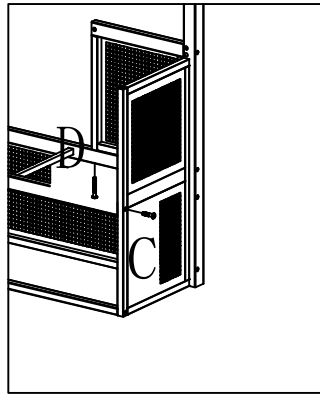



Please install number 25 first.

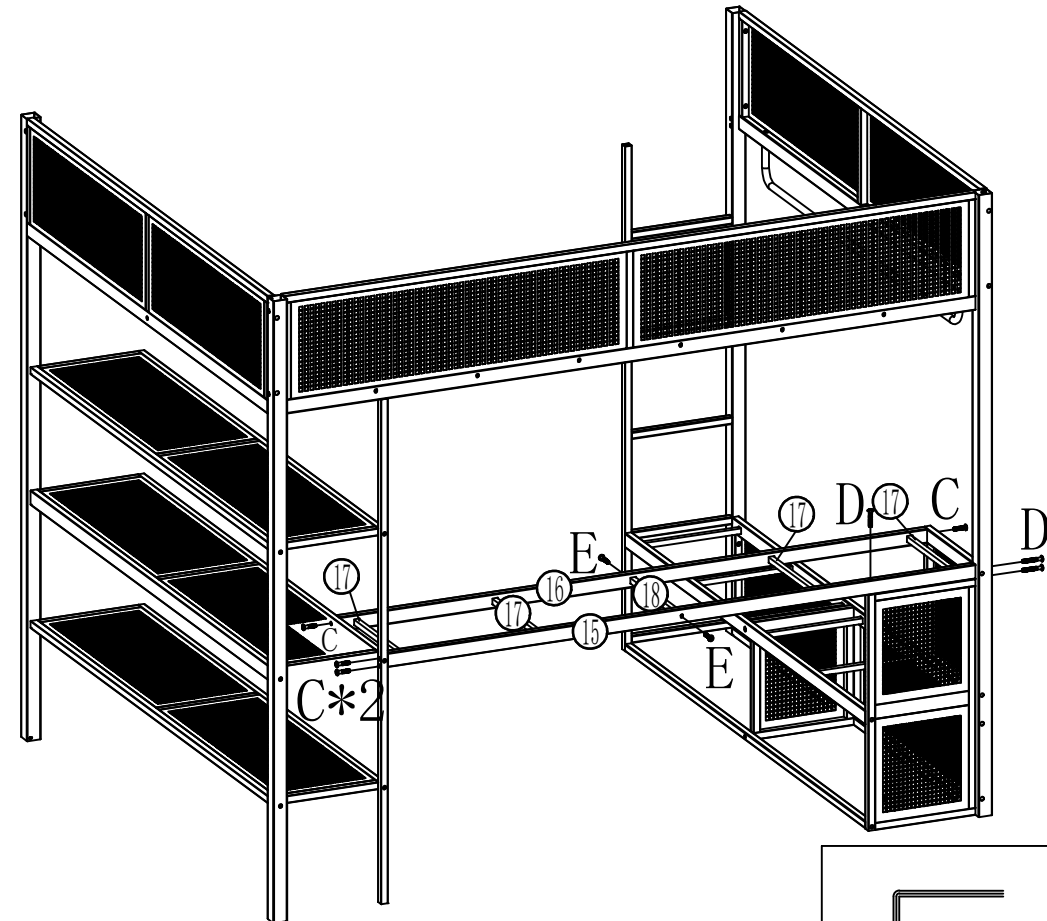

		
D 8*55-6PCS	C 8*35-3PCS	L

Step 8:



			
E 6*25-2PCS	C 8*35-4PCS	D 8*55-3PCS	M
			
			L

Step 9:

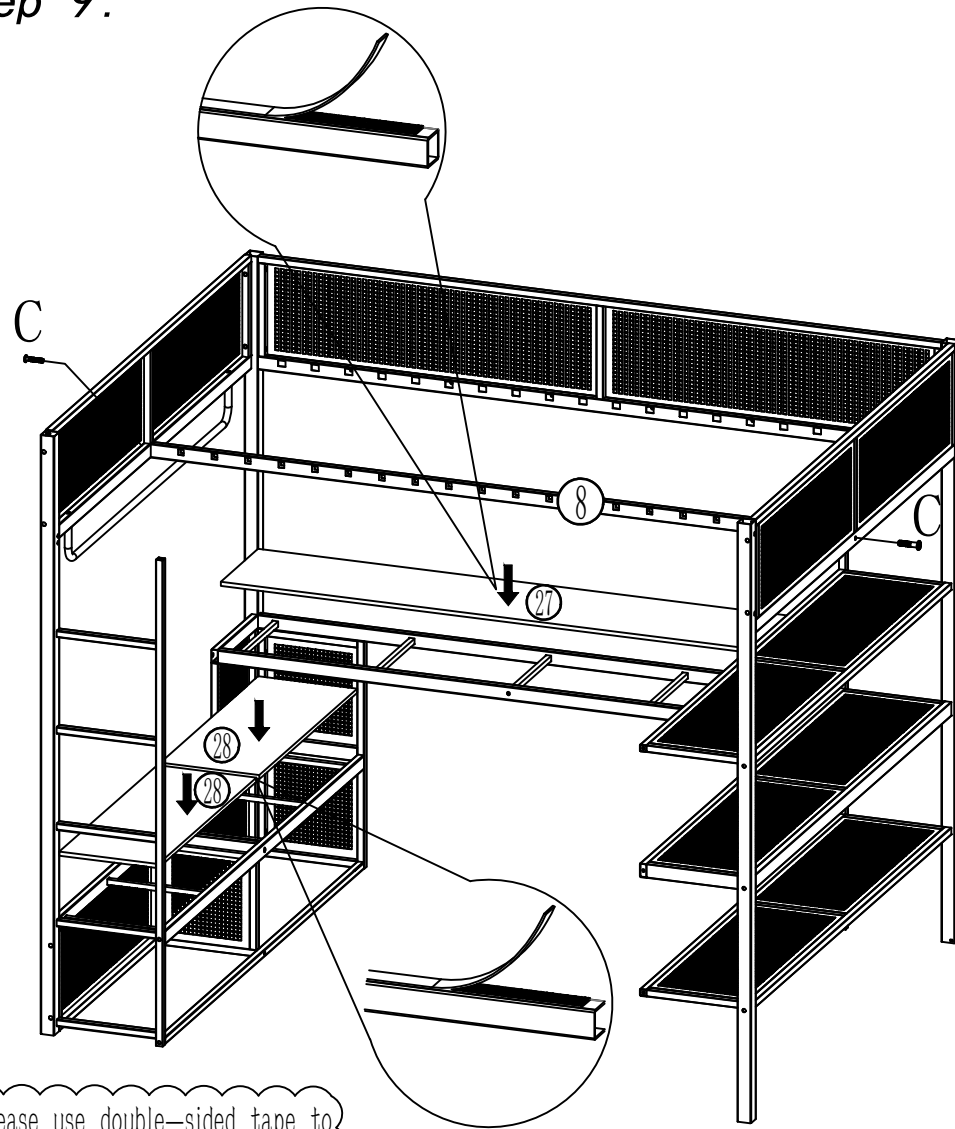

Please use double-sided tape to secure the board.



C
8*35-2PCS



L



0-1PCS

Step 10:

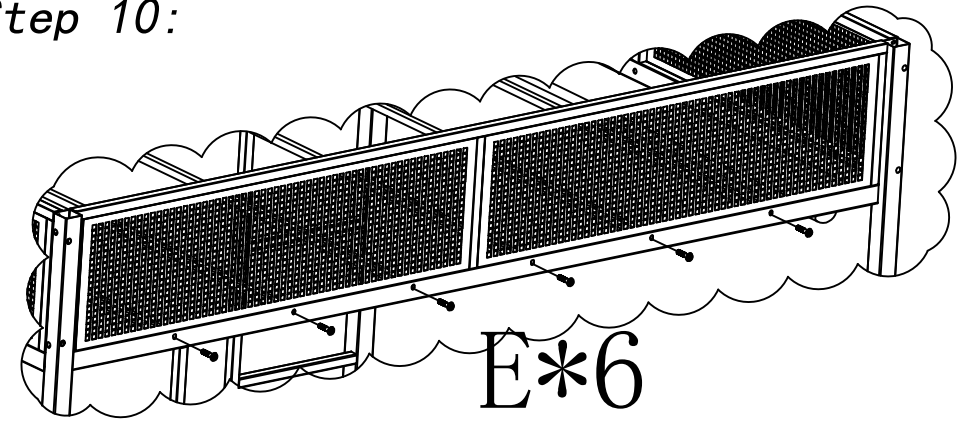

E*6

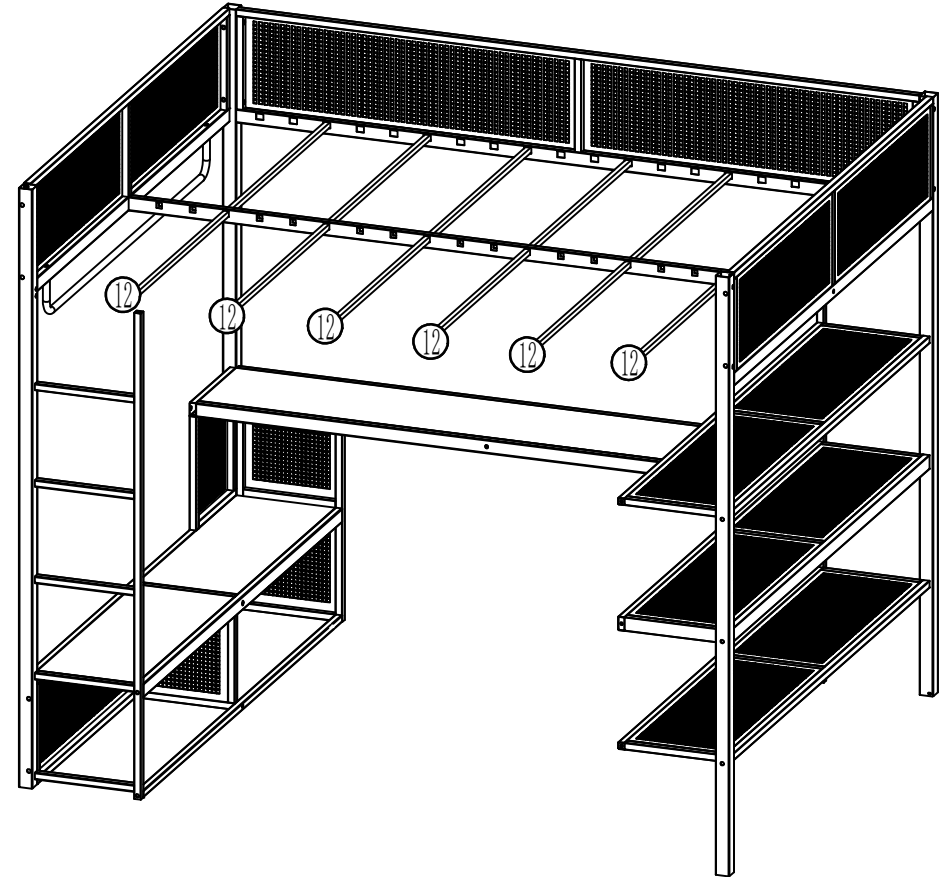

E
6*25-6PCS







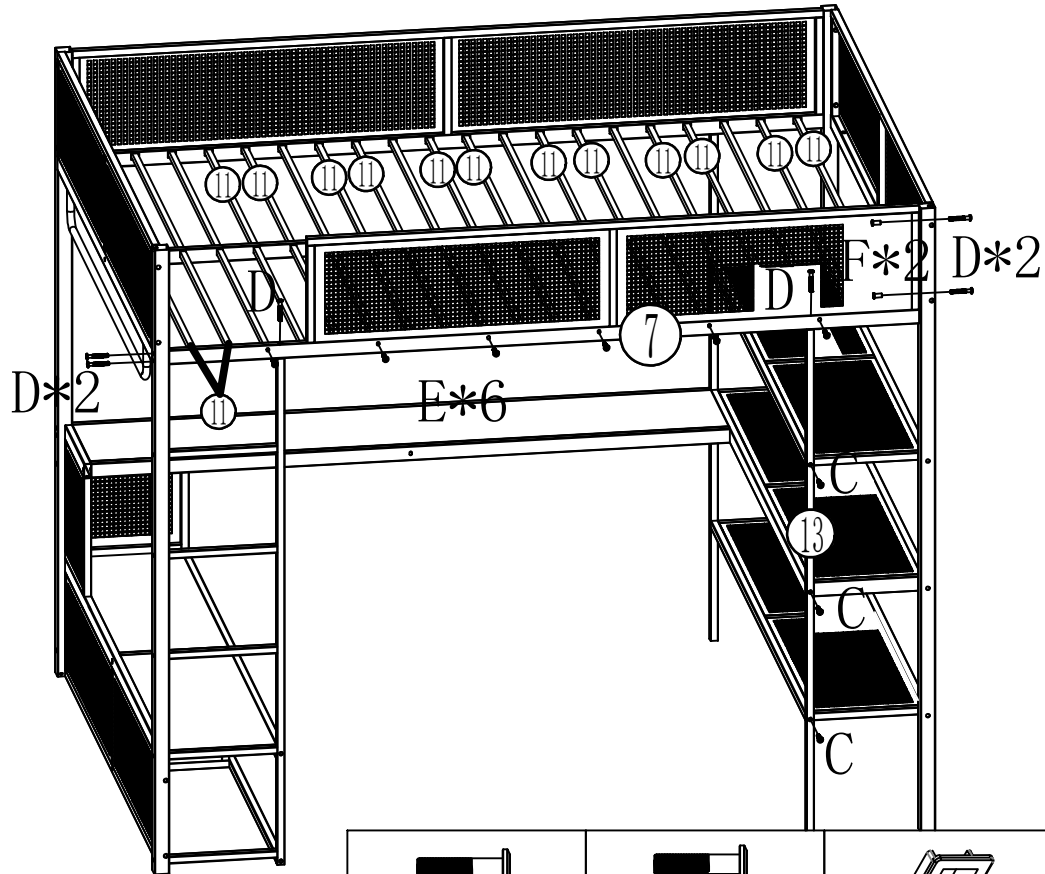
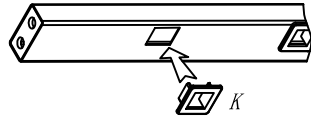

L

Step 11:

Please install part K onto number 7 before installing the number 7 assembly.

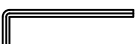

 F 8*15-2PCS	 C 8*35-3PCS	 E 6*25-6PCS	 K-20PCS
	 D 8*55-6PCS	 L	 L

Step 12:

Completed

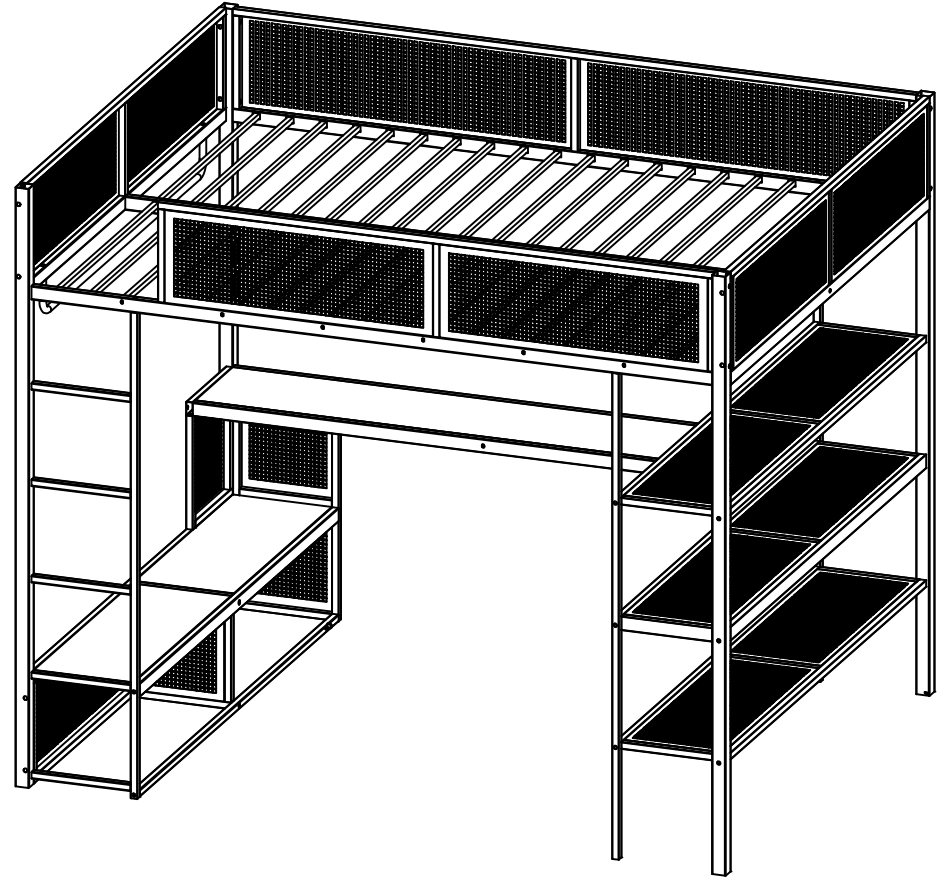

线 装 订 线 装 订 线 装 订 线 装 订 线

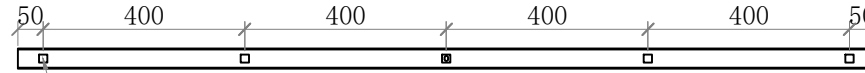
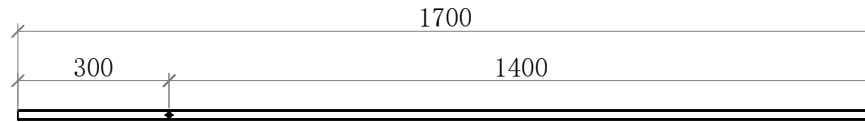

20*40/单面孔16*16/两端M8单孔内母

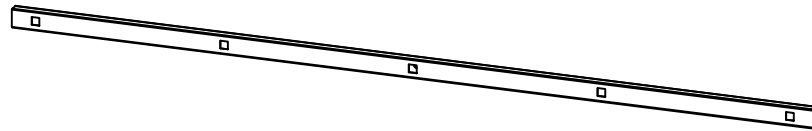

16# 1PCS/套

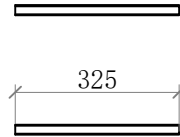

15*15/白管

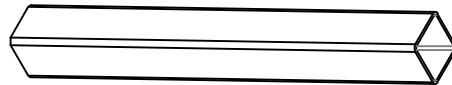

17# 10PCS/套

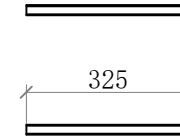

15*15/两端焊M6内母



18# 1PCS/套

铭洋家具五金有限公司

河北·沧州市东光县于桥乡陈坊工业园

- 1.本图纸标注单位为毫米(mm)；
- 2.所有尺寸以标注尺寸为准,不得以比例尺度量图纸;
- 3.本图纸须经甲方确认签字方可生效;
- 4.常规产品交货期7-15天, 烦请客户尽快签字回传, 否则工期将顺延;
- 5.版权所有, 未经本公司书面授权, 不得对本部分或全部图纸进行复印。

工程名称
ENGINEERINGNAME

--

设计
DESIGNER

客户签字
CUSTOMER SIGN

审核
CORRECTOR

交货日期
DELIVERY DATE

比例
SCALE

日期
DATE
2025/08/07