



CARRO

INSTALLATION INSTRUCTIONS

CARROHOME.COM

MANUFACTURING QUALITY
CEILING FANS SINCE FOREVER.

Important: Please read and save these instructions before installation

Basic Product Specifications

Model	CFR485Q5L-FM	Voltage	120V
Fan Blade Span	48"	Rated Wattage	42W(Fan 26W Lamp 16W)
Gross Weight	17lbs.	Motor RPM	115-230rpm
Maximum Airflow	3860CFM	Maximum Noise	58dB(A)

**U.S. Patent Nos.: 10,511,206 and 11,296,561.
Other Patent(s) Pending.**

Questions

Have questions about our products? Contact us and talk to our helpful tech support team.

Technical Support

Business Hours:

Monday – Friday (Holidays observed).

9:00 am to 5:30 pm PST.

Tel: 888-253-2374

This Carro Ceiling Fan is :



10 Speed Options



Forward Reverse
Fan Direction



DC Motor, stable & silent,
suitable for indoor use



Built with premium materials
for durability & power



Remote Control

- Before you begin installing the fan, shut power off at the circuit breaker of the fuse box.
- Make sure that all electrical connections are in accordance with National Electrical Code, ANSI/NFPA 70 and local codes. Hire a licensed electrician if you are unfamiliar with installing electrical wiring.
- Make sure the installation site you choose allows the fan blades to rotate without any obstructions. Allow a minimum clearance of 2.1m (7 feet) from the floor and 18 inches from the tip of the blades to the wall.
- The outlet box and support structure must be securely mounted and capable of reliably supporting a minimum of 35 pounds. Use only U.L. listed outlet boxes marked "Acceptable for Fan Support of 15.9 kg (35 lbs) or less".
- Before and after you install the fan, make sure that all mounting components are secured to prevent the fan from falling.
- Do not insert anything into the fan blades while the fan is operating.
- To change the direction of the rotation of the blades, the fan must be in operation mode.
- All set screws must be checked and retightened where necessary before installation.
- After making the wire connections, the wires should be spread apart with the grounded conductor and the equipment-grounding conductor on one side of the outlet box and the ungrounded conductor on the other side of the outlet box.
- The splices after being made should be turned upward and pushed carefully up into the outlet box. Conductor wiring identified as grounded is to be connected to a grounded conductor of power supply. Conductor wiring identified as ungrounded conductor is to be connected to an ungrounded conductor. Conductor wiring identified for equipment grounding is to be connected to an equipment-grounding conductor.
- This device complies with part 15 of the FCC Rules. Operation is subject to the following two conditions: (1) This device may not cause harmful interference, and (2) this device must accept any interference received, including interference that may cause undesired operation.

- **CAUTION:** Read all instructions and safety information before installing your new fan. Review accompanying assembly diagrams.
 - **WARNING:** To reduce the risk of fire, electric shock, or personal injury, mount to outlet box marked "Acceptable for Fan Support of 15.9 kg (35 lbs) or less" and use mounting screws provided with the outlet box.
 - **CAUTION:** To reduce the risk of injury, use only the screws provided with the outlet box in conjunction with the lock washers.
 - **WARNING:** To reduce the risk of personal injury, do not bend the blade bracket when installing the brackets, balancing the blades, or cleaning the fan. Do not insert foreign objects in between rotating fan blades.
 - **CAUTION:** To reduce the risk of electric shock, disconnect the electrical supply circuit to the fan before installing the light kit.
 - **WARNING:** To reduce the risk of fire or electric shock, this fan must be installed with a general use, non-dimmable, single gang, isolating wall control/switch.
 - **WARNING:** To reduce the risk of fire or electric shock, do not use this fan with any solid-state speed control device.
- NOTE:** The important safeguards and instructions appearing in this manual are not meant to cover all possible conditions and situations that may occur. It must be understood that common sense, caution and care are factors which cannot be built into this product. These factors must be supplied by the person (s) installing, caring for and operating the unit.
- **CAUTION:** The light source is designed for this specific application and can overheat if serviced by untrained personnel. If any servicing is required, the product should be returned to an authorized service facility for examination or repair.
 - **WARNING:** Do not use corrosive detergents for cleaning.

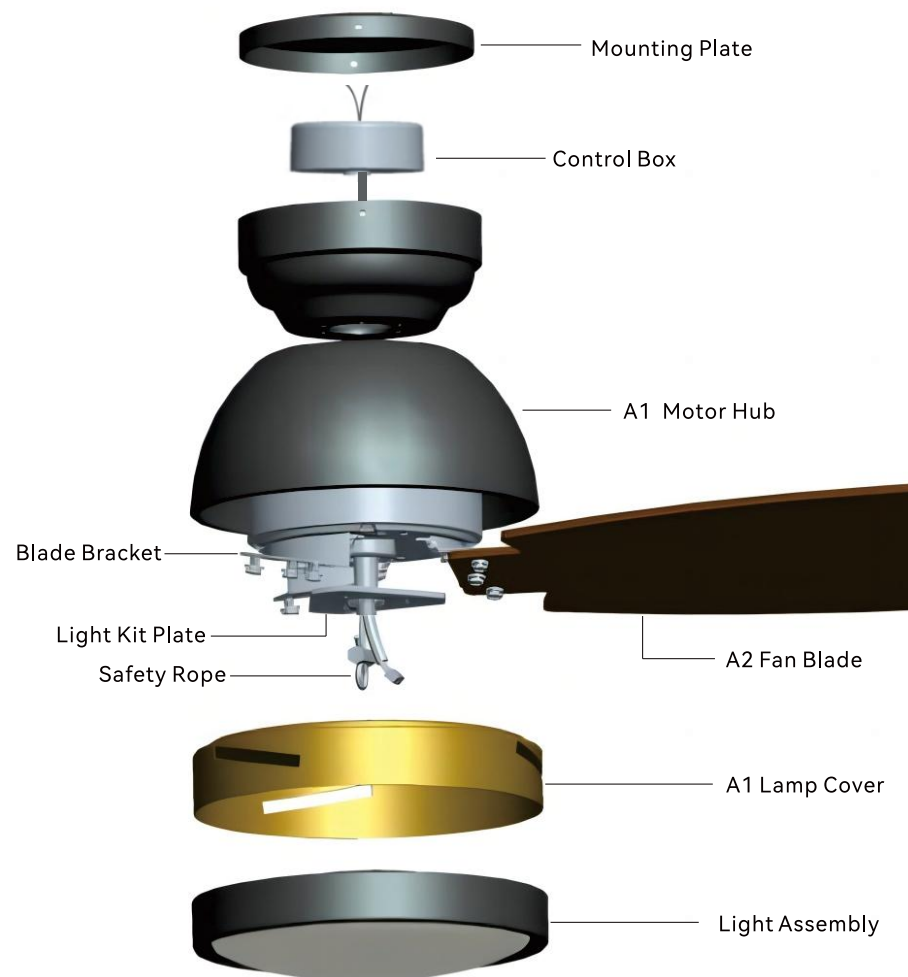

- 08 Disassembly of Motor
- 09 Mounting Options
- 10 Wiring
- 11 Securing the Fan / Fan Blade
- 12 Light Kit Pan & Light Kit
- 13 Lampshade / Power On
- 14 Remote Control
- 15 Troubleshooting
- 16 Care & Cleaning / FCC



External hexagonal wrench



Phillips screwdriver



Step ladder

Package Contents

Before installing, please check to make sure you have received all the necessary components for installation.

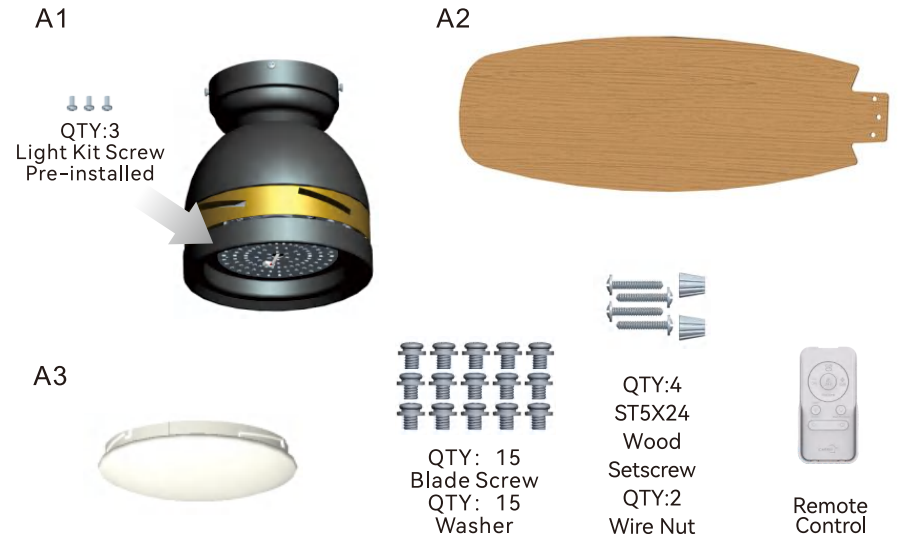

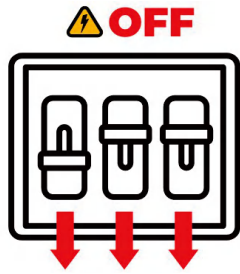

WARNING: To avoid serious injury or death, turn off the power at the circuit breaker before installing the fan.

1. Disassemble the Motor

1.1 Take the motor assembly out of the box, use a screwdriver to loosen the canopy screws and remove the mounting plate. Save the screws for later use.

1.2 Remove the light kit directly as light kit is fixed by magnetic attraction. Remove one screw from the light kit plate of the motor assembly, and loosen but DO NOT remove the other two keyhole screws. Rotate and remove the light kit pan. Save the removed light kit screw for later use.

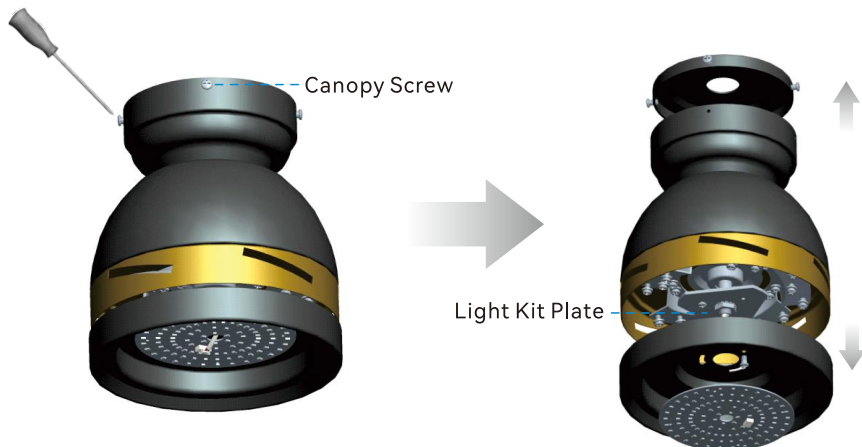

Fig 1.1

Fig 1.2

2. Install the Mounting Plate

You have two options for mounting plate installation. Pick which one works best for your location.

WARNING: Turn off the power from the breaker circuit first!

Note: For better fan performance, make sure the mounting plate is level.

Option 1: Fasten the mounting plate with the ST5×24 wood setscrews (included) when securing to the wooden ceiling beam or support structure with an approved electrical outlet box as shown in Fig 2.1.

Option 2: Use machine screws (provided with outlet box) and washers when securing to an existing ceiling fan-rated outlet box. If the mounting plate is installed at the outlet box, it should be installed on the outlet box with the screws that came with your outlet box itself. Pull the supply wires (the black, white and ground wires) out of the outlet box and through the hole in the mounting plate and lay them to the side.

WARNING: DO NOT use the plastic outlet box. Use only U.L. listed outlet boxes marked "Acceptable for Fan Support of 15.9 kg (35 lbs) or less".

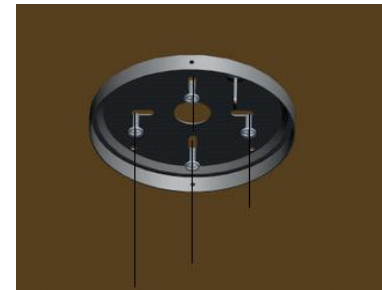

Fig 2.1



Fig 2.2

3. Hang the Fan

Carefully lift the fan-motor assembly. Hang the motor assembly on the hook of the mounting plate by utilizing one of the holes at the outer rim of the motor housing so that it is securely suspended.

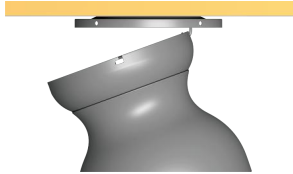

4. Connect the Wiring

The Green/Yellow wire from the mounting plate connects with the supply Ground wire using the wire nut.

Connect the White wire from the motor to the supply White (Neutral) wire using a wire nut.

Connect the Black wire from the motor to the supply Black/Red (Hot/Live) wire using a wire nut.

Then hide them inside the motor housing. (Make sure all the wires are connected to the correct colors as shown in Fig 4.1)

Attach the other end of safety rope to a safe place.

Note: Installing the ceiling fan with a safety rope is an extra safety feature. It secures the fan to the ceiling hook or safe place and avoids the fan from falling even in the case of material failure.

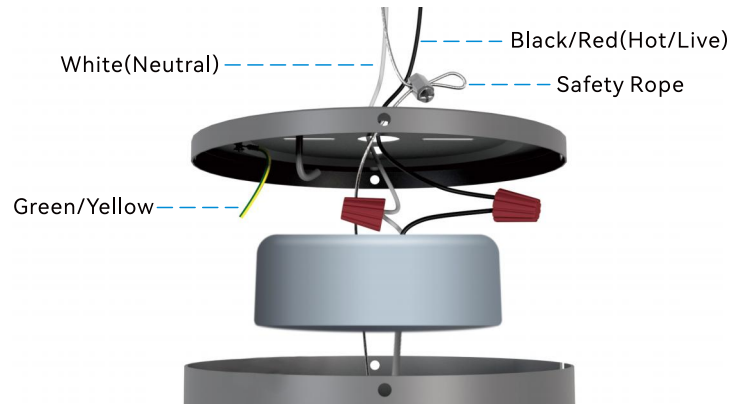

Fig 4.1

5. Secure the Fan

5.1 Reinstall two of the four canopy screws (located across from each other) that were removed in step 1 to the mounting plate, but DO NOT tighten them yet.

5.2 Using both hands, lift the fan body from the hook. Align the two key slots in the top of the motor assembly with the two loosened screws on the mounting plate.

5.3 Push the fan motor assembly up and turn it counterclockwise to lock in the mounting plate. Tighten the two screws. Reinstall the other two canopy screws into the remaining two holes and tighten the four screws firmly.

WARNING: Falling fan hazard, make sure all screws are tightened to secure the fan motor assembly.



Fig 5.1

6. Install the Fan Blades

6.1 Locate 15 blade attachment screws and washers in the hardware pack. Slide the blade through the lamp cover and align the blade holes with the screw holes of the blade bracket and fasten the blades with the screws and washers as shown in Fig 6.1.

6.2 Repeat for the remaining blades. The installation of the blades is shown in the Fig 6.2.

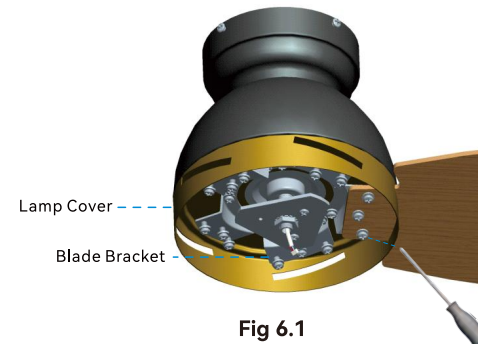

Fig 6.1

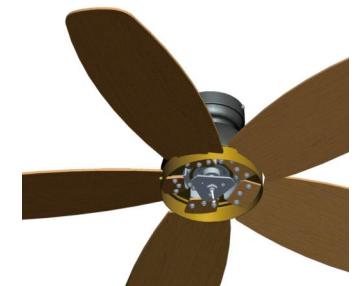

Fig 6.2

7. Install the Light Kit Pan & Light Kit

7.1 Push the light kit pan to the light kit plate of the motor hub so that the two loosened screw heads fit into the keyhole slots.

Feed the light wire connector plug and safety rope through center hole of the light kit pan. Turn the light kit pan clockwise.

Install back the removed light kit screw. Make sure all the screws are firmly tightened.

7.2 Allow the light wire connector plug and safety rope to come through the light kit. Reinstall the light kit. The light kit is magnetically attracted to the pan with the help of magnets. Insert the light wire connector plug to the light kit terminal block.

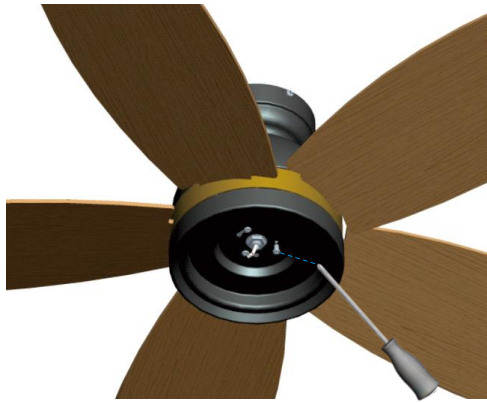

Fig 7.1

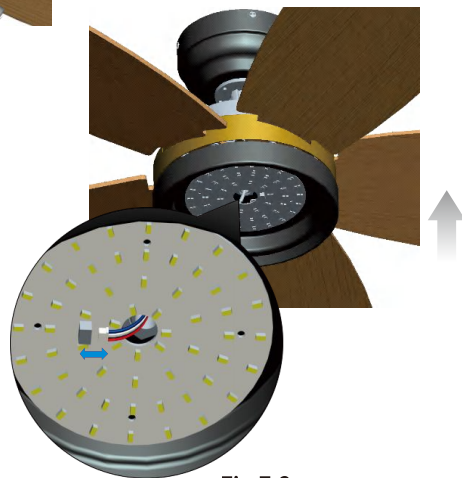

Fig 7.2

8. Install the Lampshade

Rotate the lampshade clockwise and securely lock into the light kit pan as shown in Fig 8.1.

WARNING: To prevent SERIOUS INJURY or DEATH, make sure that the lampshade is properly secured. Allow the lampshade to cool completely before removing.

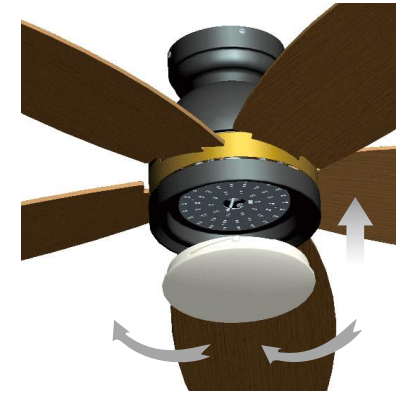



Fig 8.1

9. Power On

At this time, the ceiling fan has been installed. Turn on the power supply from the breaker circuit of the main switch or the room where the ceiling fan is installed. After the power is on, observe whether the fan light is on.



Pair the Remote Control to Your Fan

Power on the fan and pair the remote to the fan within 1 min. To pair remote to fan, press and hold  button for 3-5 secs to pair remote to the fan. Successful pairing will trigger the fan light off.

Remote Control Button Definitions



Turns the fan off.



Switches between summer mode and winter mode.

· Summer mode - (Counter-clockwise)

A downward airflow creates a cooling effect.

· Winter mode - (Clockwise)

An upward airflow moves warm air away from the ceiling area and redistributes it around the living space.



Turns the fan on and decreases fan speed.



Turns the fan on and increases fan speed.

Nature Switches the fan speed between nature mode and normal mode. Simulates a natural breeze, gentle enough not to disturb while you sleep.



Turns the lights on or off and RF pairing.

Note: Power on the fan and pair the remote to the fan within 1 min. To pair remote to fan, press and hold  button for 3-5 secs to pair remote to the fan. Successful pairing will trigger the fan light off.



Switches between warm light and cool light.



Press/Hold button to decrease the light intensity.



Press/Hold to button to increase the light intensity.

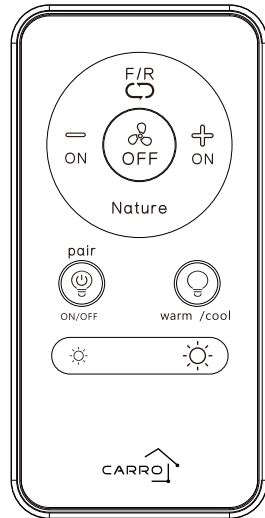

Try these troubleshooting steps before contacting Customer Service. For additional operation, maintenance, and troubleshooting information, please contact our customer service center.

SYMPTOM	POSSIBLE SOLUTION
Fan not spinning	① Make sure the fan is getting power. ② Check your circuit breaker or fuse panel and wall switch for functionality. ③ Check to make sure the fan wires are correctly connected to the house wires. ④ Remote control must be paired with the fan within 1 minute after connecting the fan to the electricity. ⑤ Use a multi-meter and test the wiring harness to see if there is any electrical output. ⑥ All the pin wiring on the circuit board must be inserted tight and in the correct position. ⑦ Remote needs to be paired with the fan first. ⑧ Make sure the fan blades spin freely. ⑨ If you're using a wall control, check the power to the breaker from your control and try working your ceiling fan manually. (Normal switch only for the fan power on/off)
Fan light not working	① Make sure LED wires are connected to the circuit board. ② Make sure the whole fan is powered.
The fan is noisy and wobbling	① Check if the blade screws are NOT rubbing against any part of the motor housing. ② Check the pin wires are NOT connected against any moving parts. ③ Check the down fan cup is NOT hitting the motor. ④ Confirm the canopy is NOT touching the ceiling while the fan is in operation. ⑤ Check the down rod is NOT slanted. ⑥ Tighten any loose screws on the light kit, fan blades, motor coupling, down rod, brackets and mounting hardware. ⑦ Confirm the hanger ball is firmly seated in the mounting bracket. ⑧ The ceiling beam must meet the minimum tensile test strength of 30KG for installation. ⑨ Make sure the blades and brackets are NOT bent or deformed. ⑩ Verify the wire connections are not rattling against each other. ⑪ Verify the fan blades are not cracked. If the fan blades are cracked, replace the damaged blades with a new blade set from the same brand as your ceiling fan to ensure compatibility. ⑫ Confirm the light kit is NOT slanting and hitting the motor.
Unable to pair remote	① Check if the wires are connected in the correct position or not. ② Check the batteries in the remote. ③ Disconnect the power for 10 minutes, reconnect the power and pair the remote with the fan immediately, within 1 minute. Also try pairing.
Fan or light turning on or off by themselves	① Confirm the circuit breaker is not malfunctioning. ② Verify the wire connections are not frayed. ③ Cut the fan power for 10 minutes then power on again. ④ All the pin wiring on the circuit board must be inserted tight and in the correct position.

WARNING: Do not expose the remote control to direct contact with water.

- 1 Check the support connections, brackets, and blade attachments twice a year. Make sure they are secure. Because of the fan's natural movement, some connections may become loose over time. It is not necessary to remove the fan from the ceiling.
2. Clean your fan periodically. Use only a soft brush or lint-free cloth to avoid scratching the finish. The plating is sealed with a lacquer to minimize discoloration or tarnishing.
3. (Optional) Apply a light coat of furniture polish to the wood blades.
4. (Optional) Cover small scratches with a light application of shoe polish.

DO NOT:

1. Use water when cleaning. Water could damage the motor, or the wood, or possibly cause an electrical shock.
2. Apply oil to your fan or motor. The motor has permanently lubricated sealed ball bearings.

WARNING: Power off the fan before performing maintenance or cleaning the fan.

FCC Statement

Note: This equipment has been tested and found to comply with the limits for a Class B digital device, pursuant to part 15 of the FCC Rules. These limits are designed to provide reasonable protection against harmful interference in a residential installation. This equipment generates, uses and can radiate radio frequency energy and, if not installed and used in accordance with the instructions, may cause harmful interference to radio communications. However, there is no guarantee that interference will not occur in a particular installation. If this equipment does cause harmful interference to radio or television reception, which can be determined by turning the equipment off and on, the user is encouraged to try to correct the interference by one or more of the following measures:

- Reorient or relocate the receiving antenna.
- Increase the separation between the equipment and receiver.
- Connect the equipment into an outlet on a circuit different from that to which the receiver is connected.
- Consult the dealer or an experienced radio/TV technician for help.

WARNING: Changes or modifications to this unit not expressly approved by the party responsible for compliance could void the user's authority to operate the equipment.