

Owner Manual

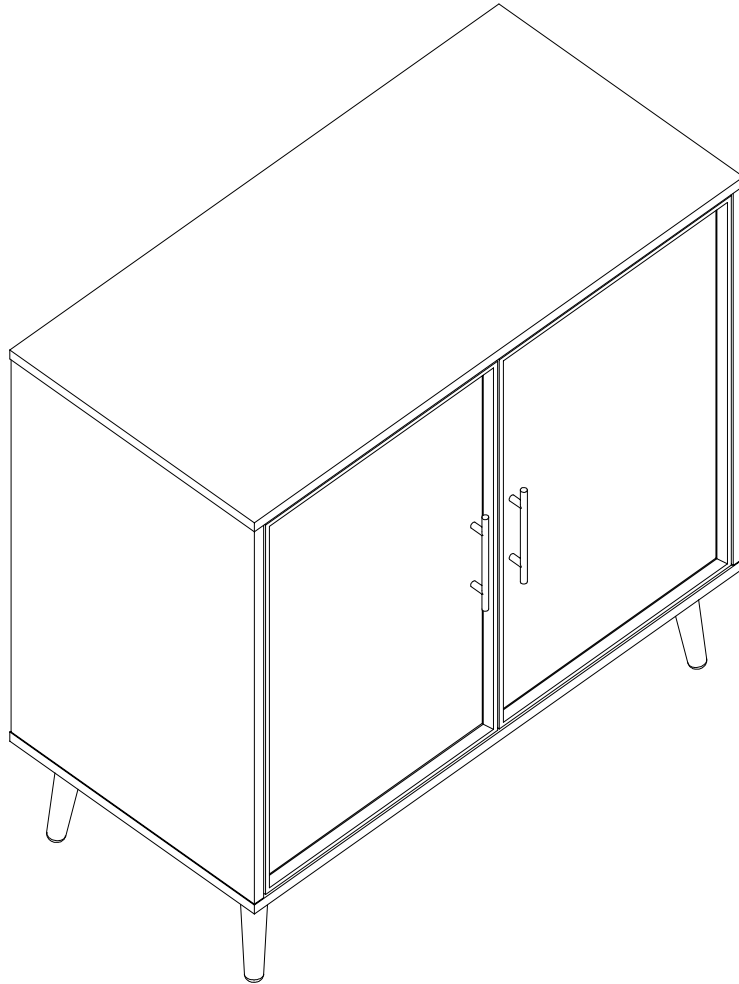

NOTE:

This brochure contains **IMPORTANT** safety info. Please read and keep for future reference.

MAINTENANCE AND WARNING

- 1.Keep furniture away from heat sources.
- 2.Do not clean furniture with harsh cleaner or polishes.Do not use detergents,solvents,abrasives,spray packs or leather cleaner. Use non-color mild soap with warm water to clean spills(Mix 1:10 soap to water).
- 3.Do not place furniture under direct sunlight,material will possibly fade over time.
- 4.Do not use on site dry cleaning machine.Children should not climb or jump on the furniture.
- 5.Do not write on furniture that is not protectedby a padded barrier.
- 6.Not for commercial use,only for residential use.





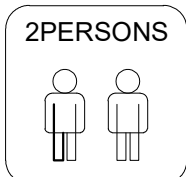
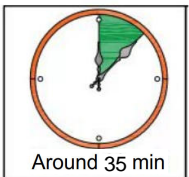
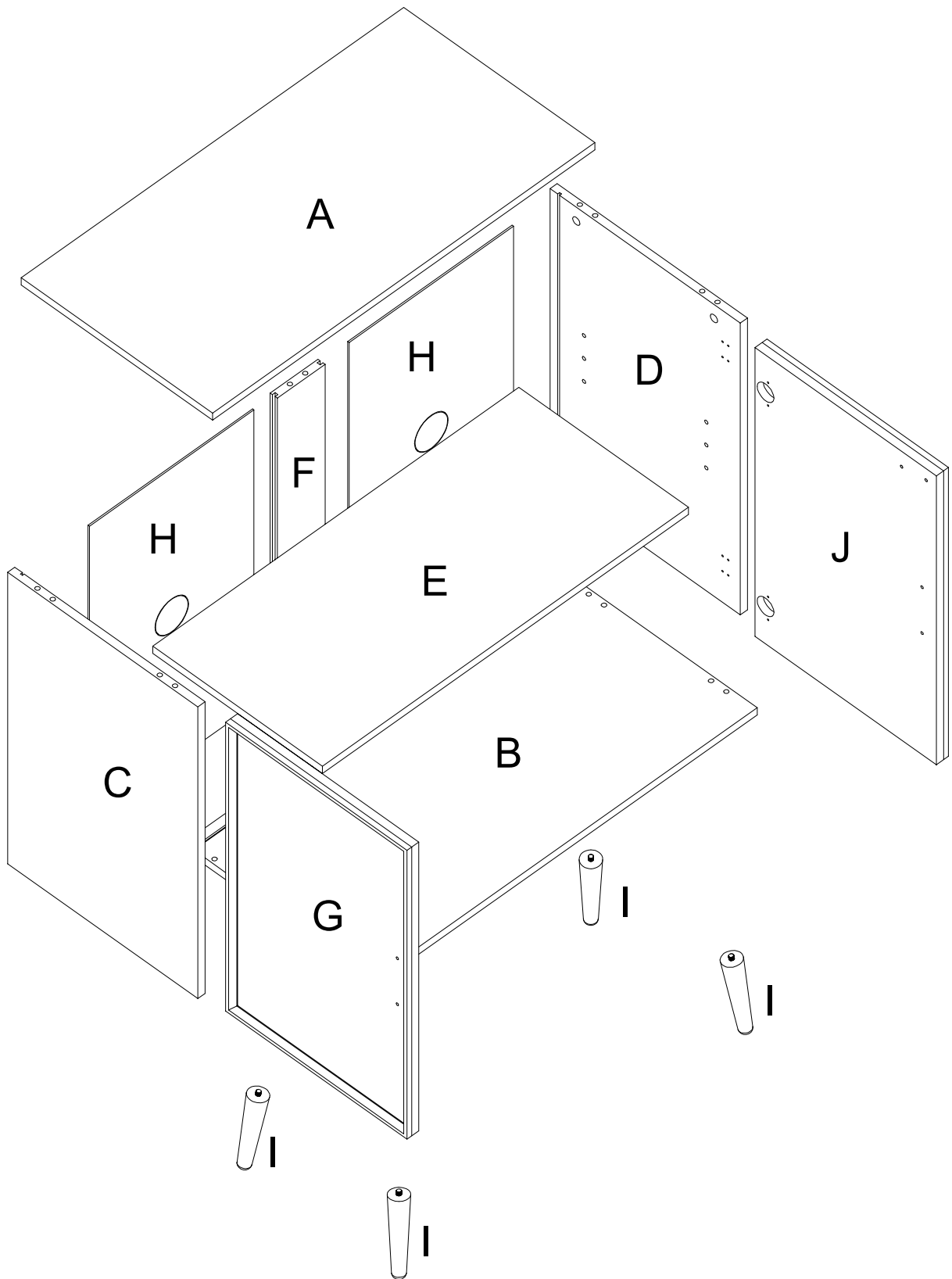

Weight Limitation



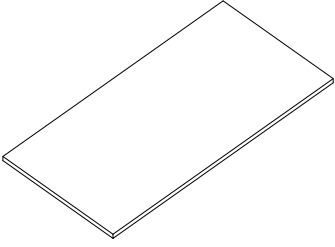
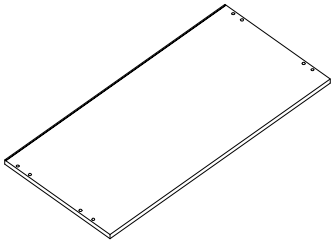
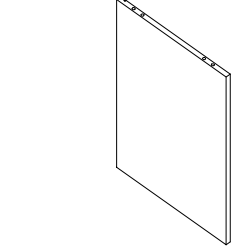
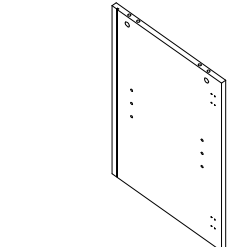
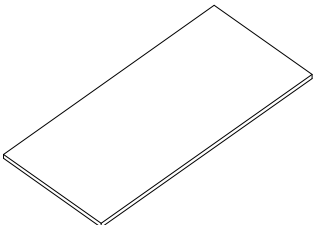

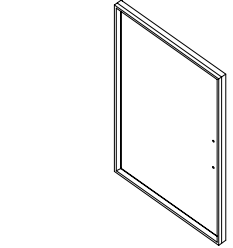
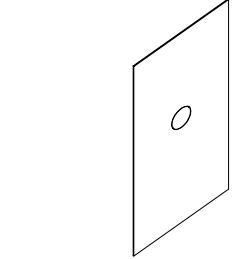

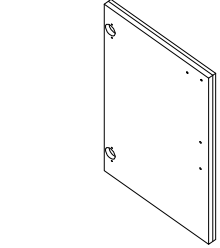



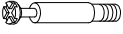

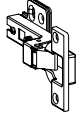

150 LBS

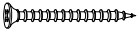

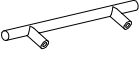

PARTS LIST

A	X1	B	X1	C	X1	D	X1
							
E	X1	F	X1	G	X1	H	X2
							
I	X4	J	X1				
							

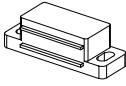
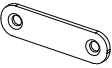
HARDWARE LIST

#1	x6		M6x35mm
#2	x6		Φ15mm
#3	x8		Φ8x30mm
#4	x6		M7x50mm
#5	x4		
#6	x44		M3.5x14mm
#7	x4		M4x35mm
#8	x4		Φ20
#9	x8		14x14x9mm
#10	x4		Ø5mm
#11	x4		M6x20mm
#12	x2		150mm
#13	x4		M4x18mm
#14	x4		
#15	x4		
#16	x2		
#17	x2		
#18	x2		

TOOL LIST

#19	x1		4#
#20	x1		

HARDWARE SPARE LIST

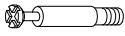
#1	X1
	
M6x35mm	

#2	X1
	
Φ15mm	

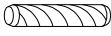
#3	X1
	
Φ8x30mm	

#4	X1
	
M7x50mm	

#6	X2
	
M3.5x14mm	

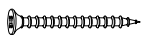
#7	X1
	
M4x35mm	

#9	X1
	
14x14x9mm	

#10	X1
	
Ø5mm	

#13	X1
	
M4x18mm	

ASSEMBLY INSTRUCTIONS

STEP-1

Insert bolt #1 into panel A, tighten bolt #1 with screwdriver #20.
Pass screw #6 through #17 and secure it with screwdriver #20

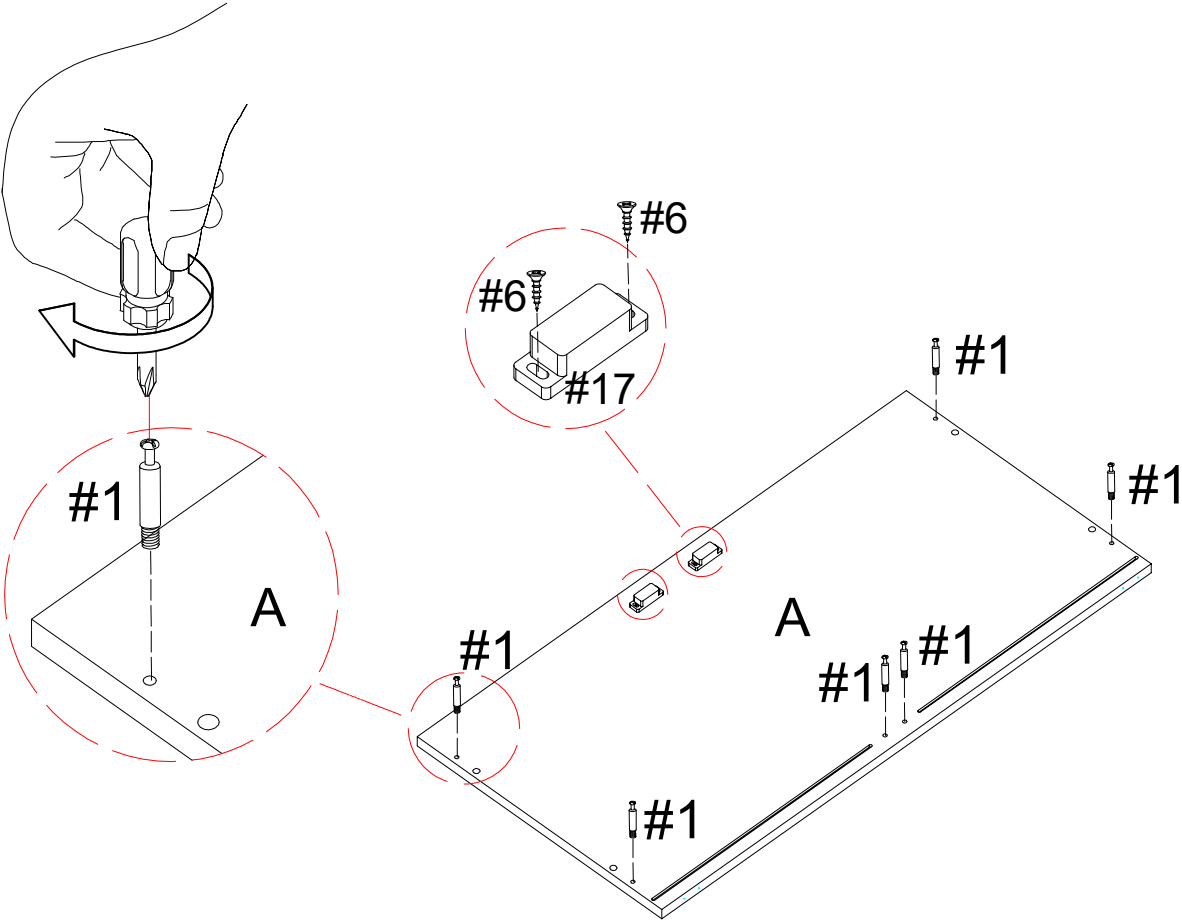

#6	x4
	
M3.5x14mm	

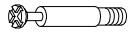
#1	x6
	
M6x35mm	

#20	x1
	

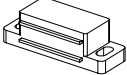
#17	x2
	

ASSEMBLY INSTRUCTIONS

STEP-2

1. Insert wooden dowel #3 into the corresponding hole of panel #A and Insert panel C & D Into panel A make sure all holes aligned .
2. Insert cam bolt #2 into the corresponding hole of panel C & D, tighten cam bolt #2 with screwdriver #20 ,finally stick paster #8 on it.

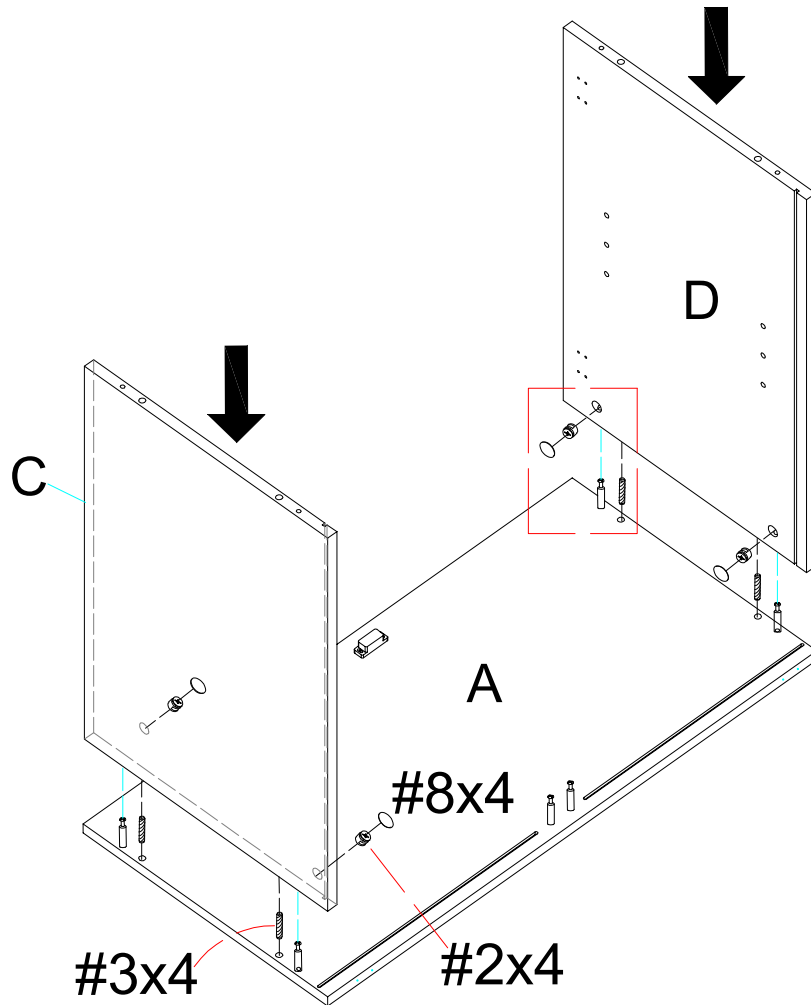
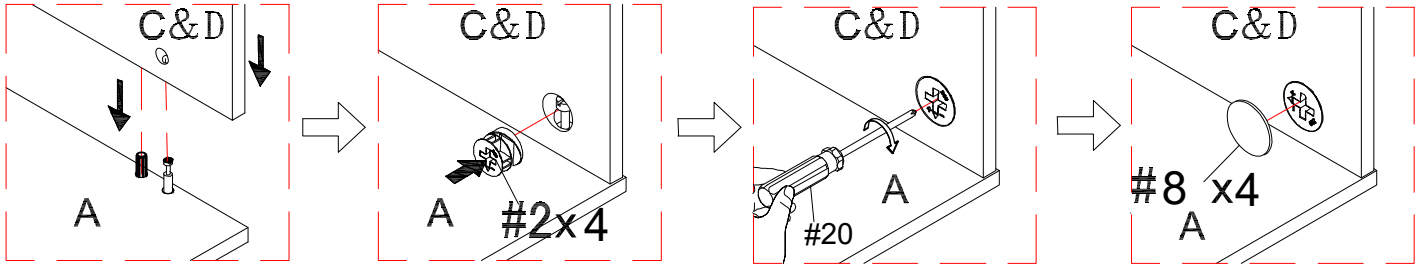

#2	X4
	
Φ15mm	

#3	X4
	
Φ8x30mm	

#8	X4
	
φ20	

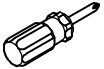
#20	X1
	

ASSEMBLY INSTRUCTIONS

STEP-3

Insert panel F into panel A, make sure all holes aligned and insert cam bolt #2 into the corresponding hole of panel F, tighten cam bolt #2 with screwdriver #20,

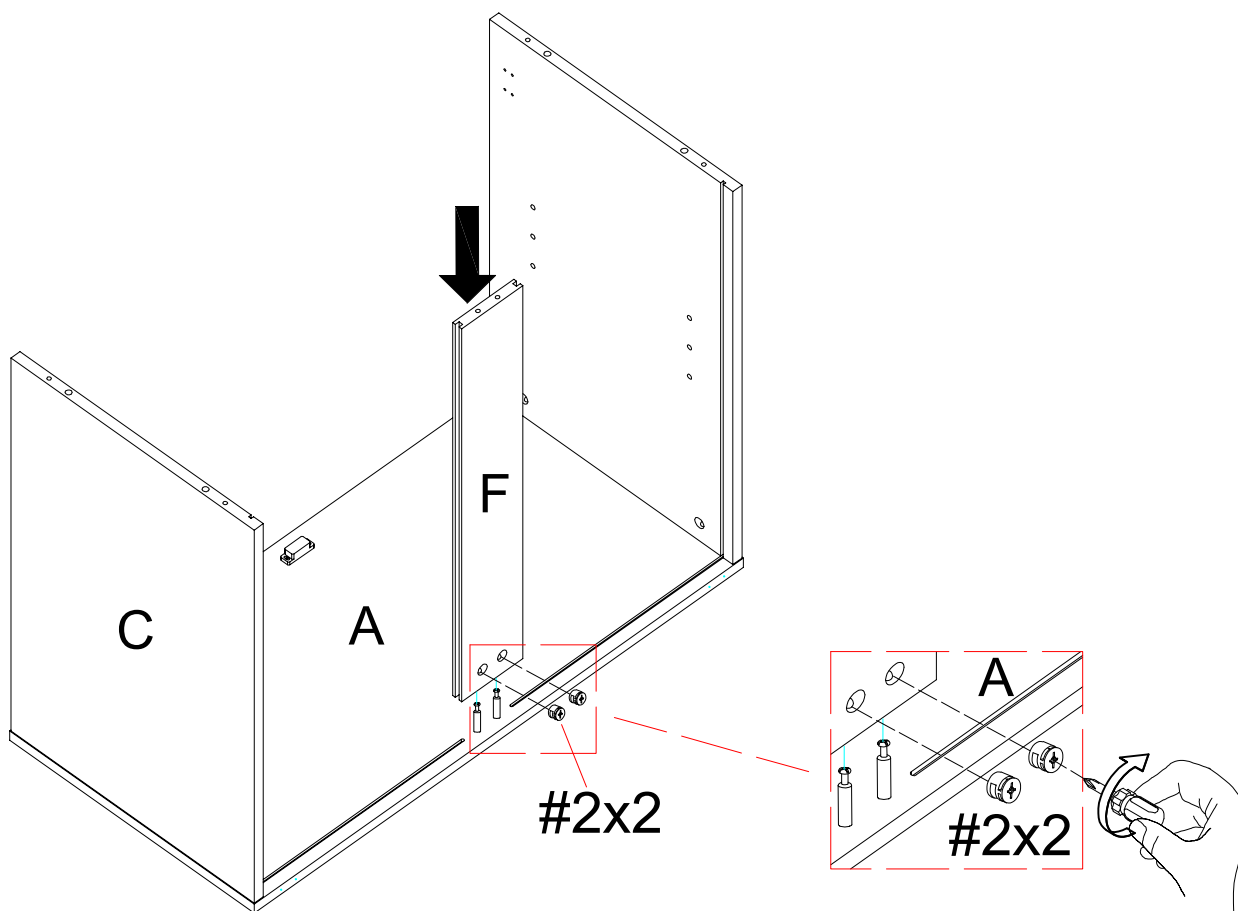

#2	x2
	
Φ15mm	

#20	x1
	

ASSEMBLY INSTRUCTIONS

STEP-4

Carefully align and slide panel H into the groove along rear edge of pre-assembled step 3.

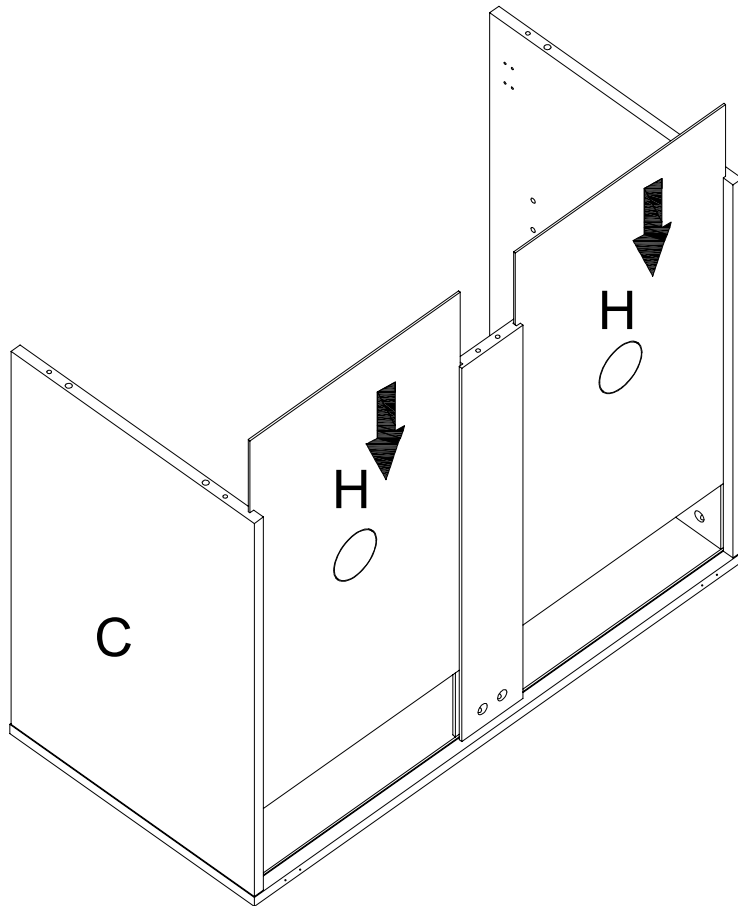



ASSEMBLY INSTRUCTIONS

STEP-5

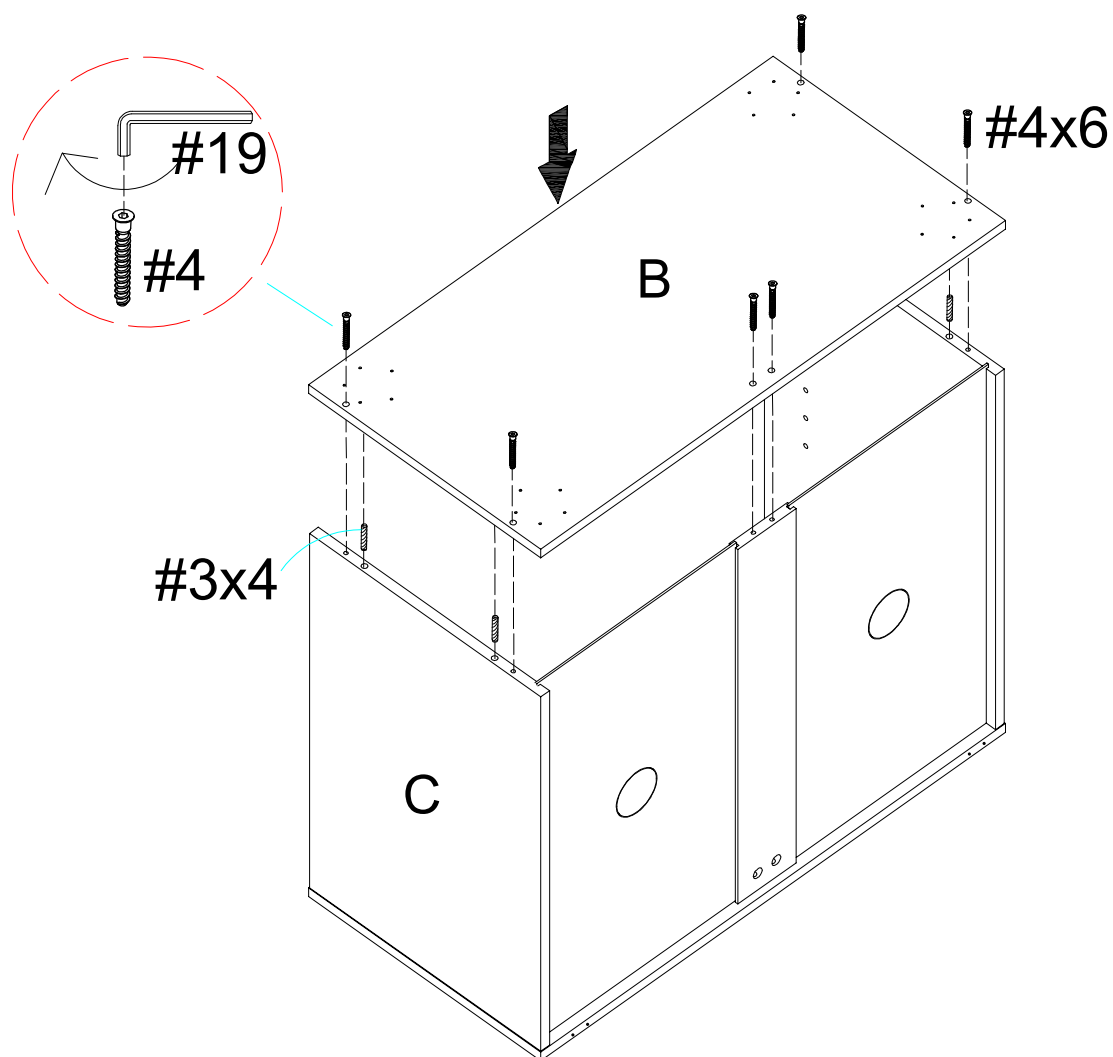
Insert wooden dowel #3 into the corresponding hole of panel C&D&F, and then insert bottom panel B into the preassemble step4, make sure all holes aligned and use bolt #4 to attach them, tighten bolt #4 with allen key #19



#3	x4
	
Φ8x30mm	

#4	x6
	
M7x50mm	

#19	x1
	
4#	

ASSEMBLY INSTRUCTIONS

STEP-6

Rotate legs #I onto the part B as shown

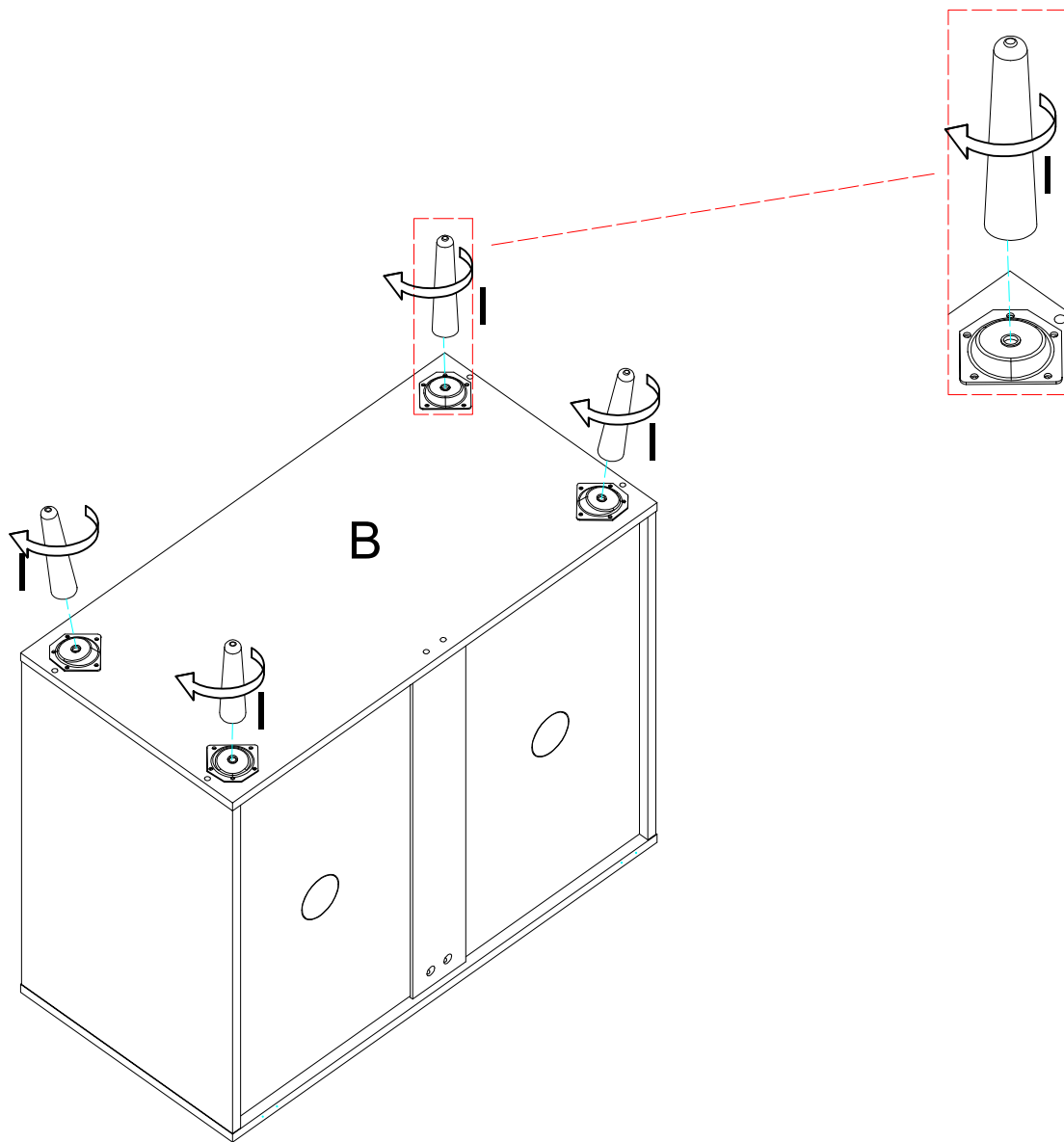

I	X4
	

ASSEMBLY INSTRUCTIONS

STEP-7

Rotate adjustable foot #11 onto legs I as shown

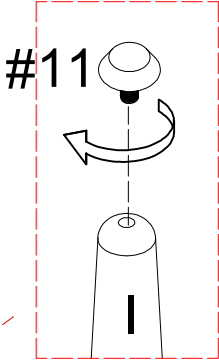

X4

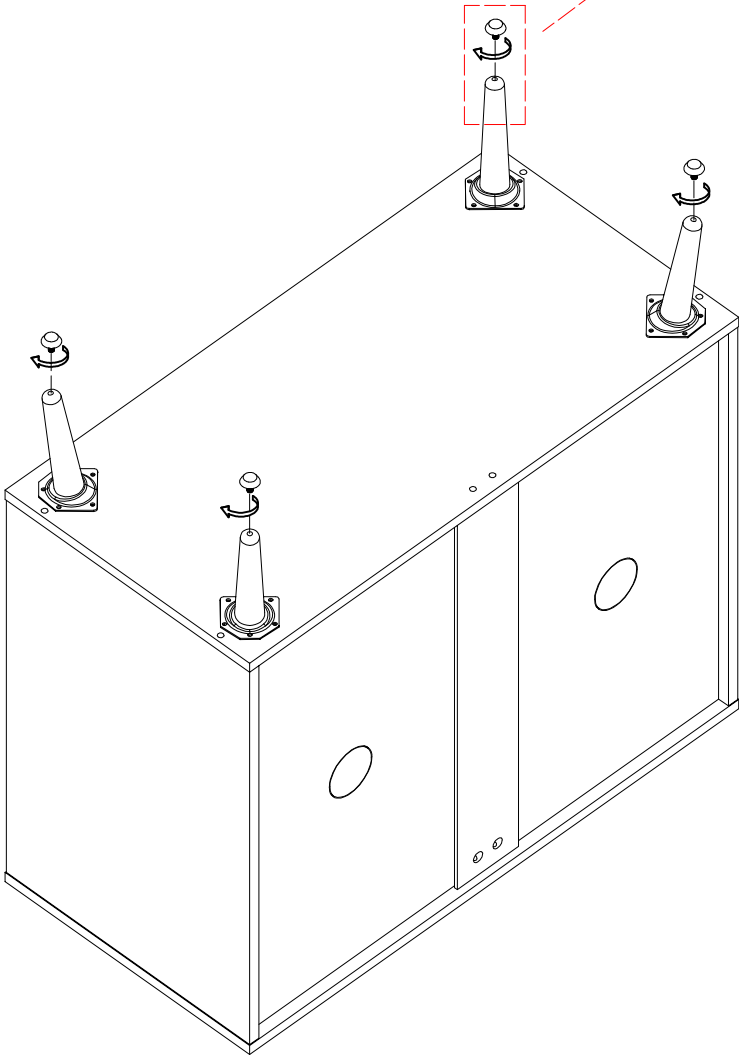



#11	X4
M6x20mm	

ASSEMBLY INSTRUCTIONS

STEP-8

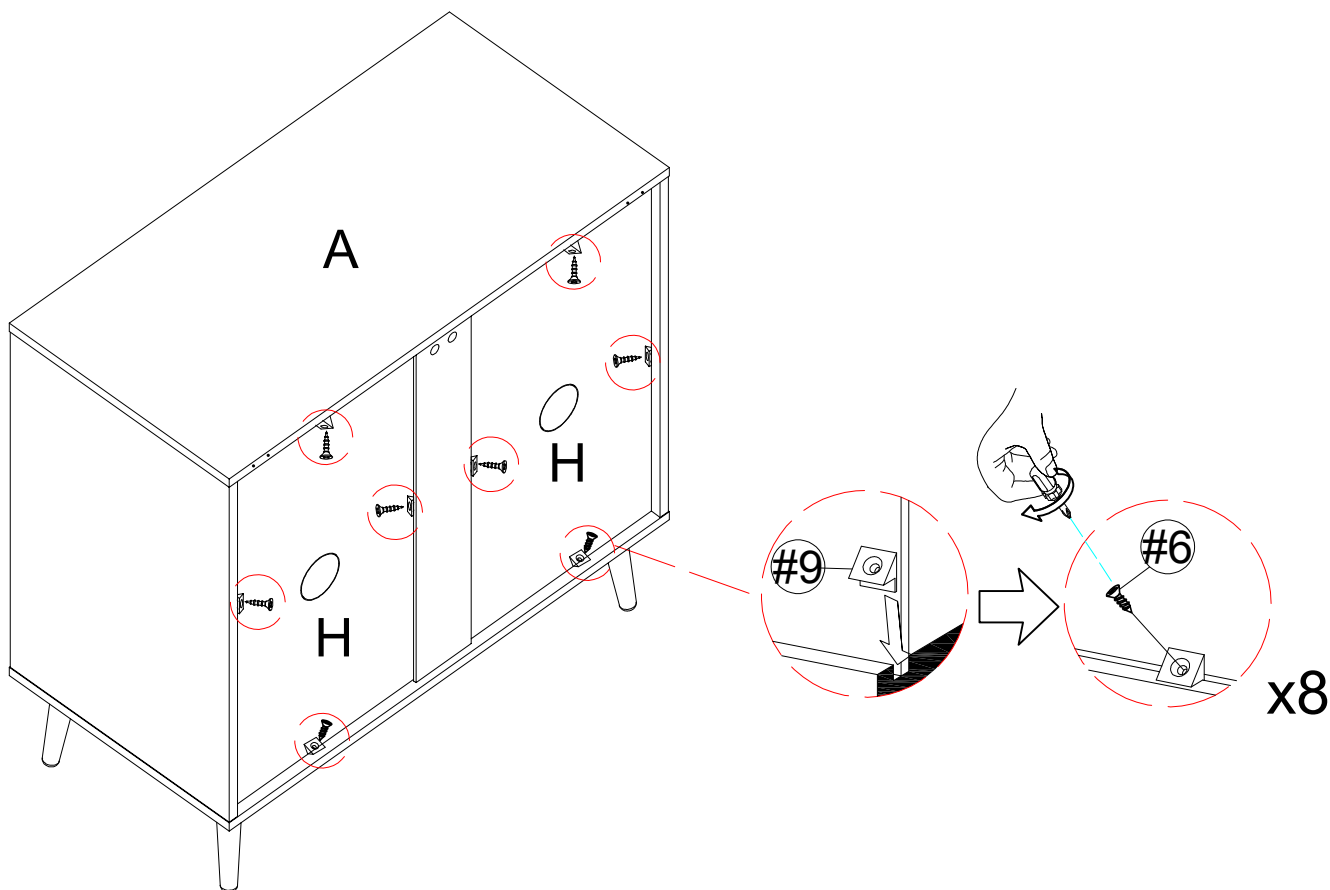
Insert hardware #9 into part H as shown, use screw #6 to attach it, tighten screw #6 with screwdriver #20



#6	x8
	
M3.5x14mm	

#9	x8
	
14x14x9mm	

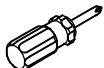
#20	x1
	

ASSEMBLY INSTRUCTIONS

STEP-9

Insert shelf holder #10 into the corresponding hole of panel C & D and
Attach adjustable shelf E to on shelf holder#10 .
Shelf holder can be adjusted up or down.

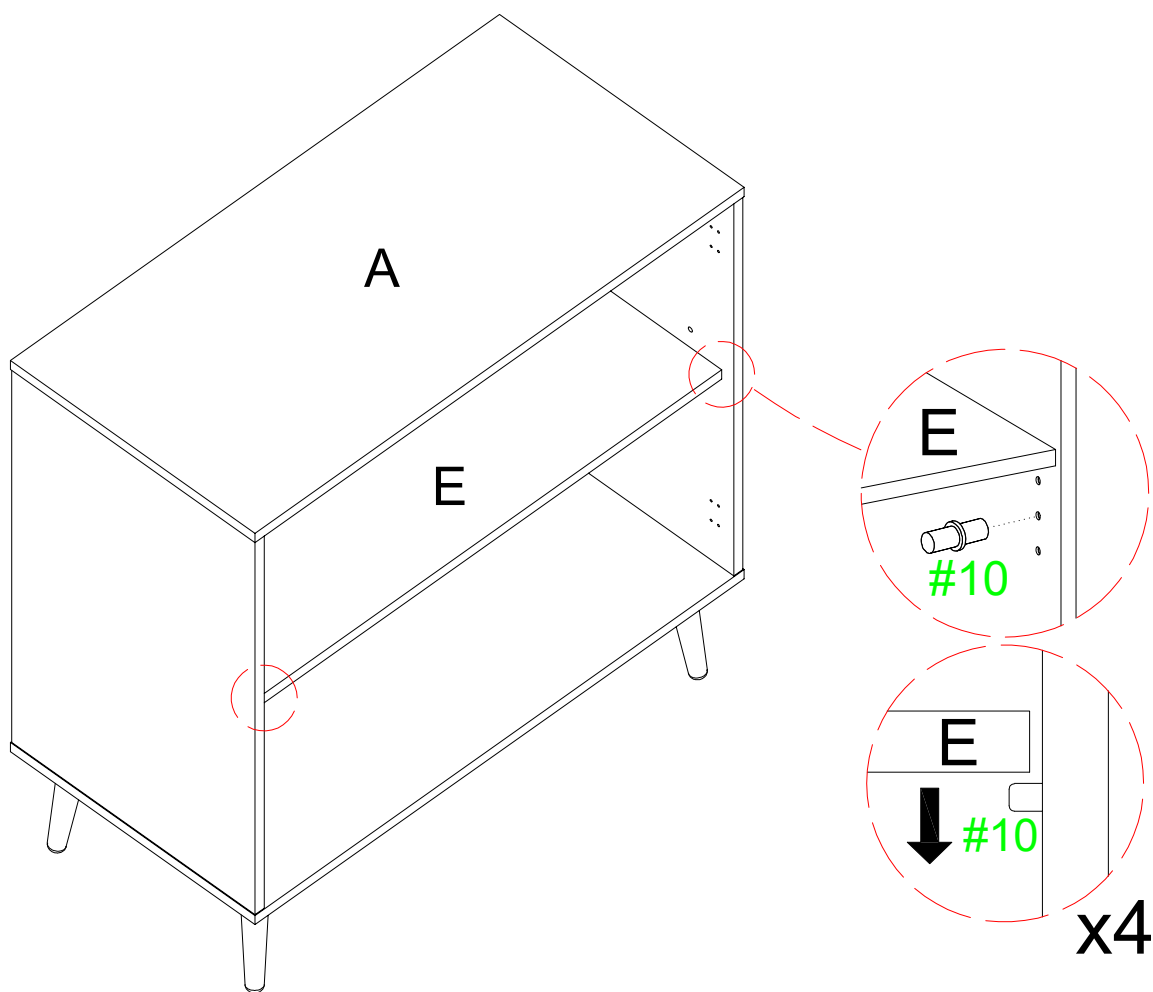

#10	x4
	
Ø5mm	

ASSEMBLY INSTRUCTIONS

STEP-10

Use screw #6 to attach the hinge #5 to door panel G, tighten screws #6 with screwdriver #20. Use bolt #13 to attach handle #12 to door panel G, tighten bolts with screwdriver #20

Pass screw #6 through #18 and secure it with screwdriver #20.

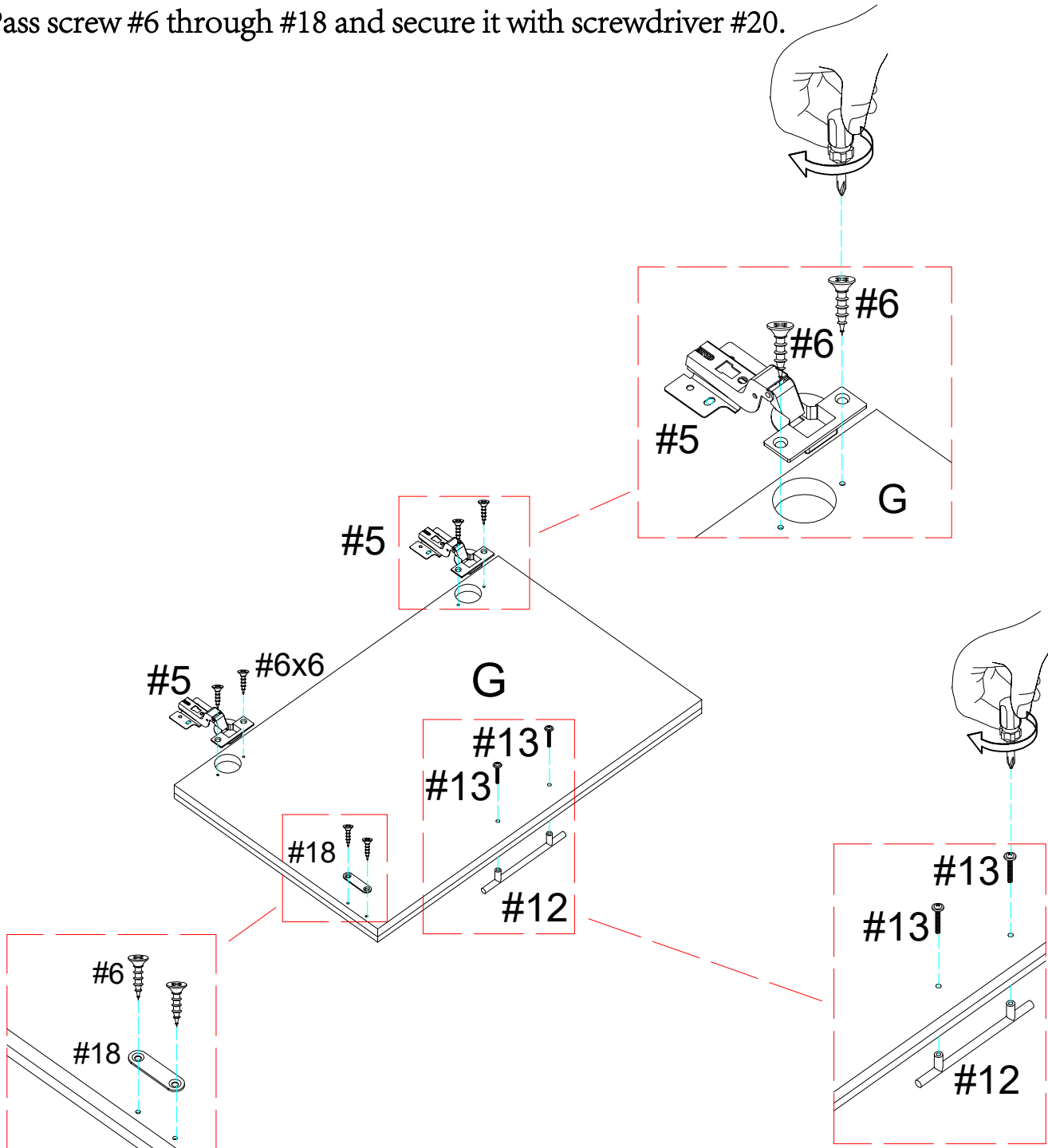

#5	x2

#6	x6
M3.5x14mm	

#12	x1
150mm	

#13	x2
M4x18mm	

#18	x1

#20	x1

ASSEMBLY INSTRUCTIONS

STEP-11

Use screw #6 to attach the hinge #5 to door panel J, tighten screws #6 with screwdriver #20. Use bolt #13 to attach handle #12 to door panel J, tighten bolts with screwdriver #20

Pass screw #6 through #18 and secure it with screwdriver #20.

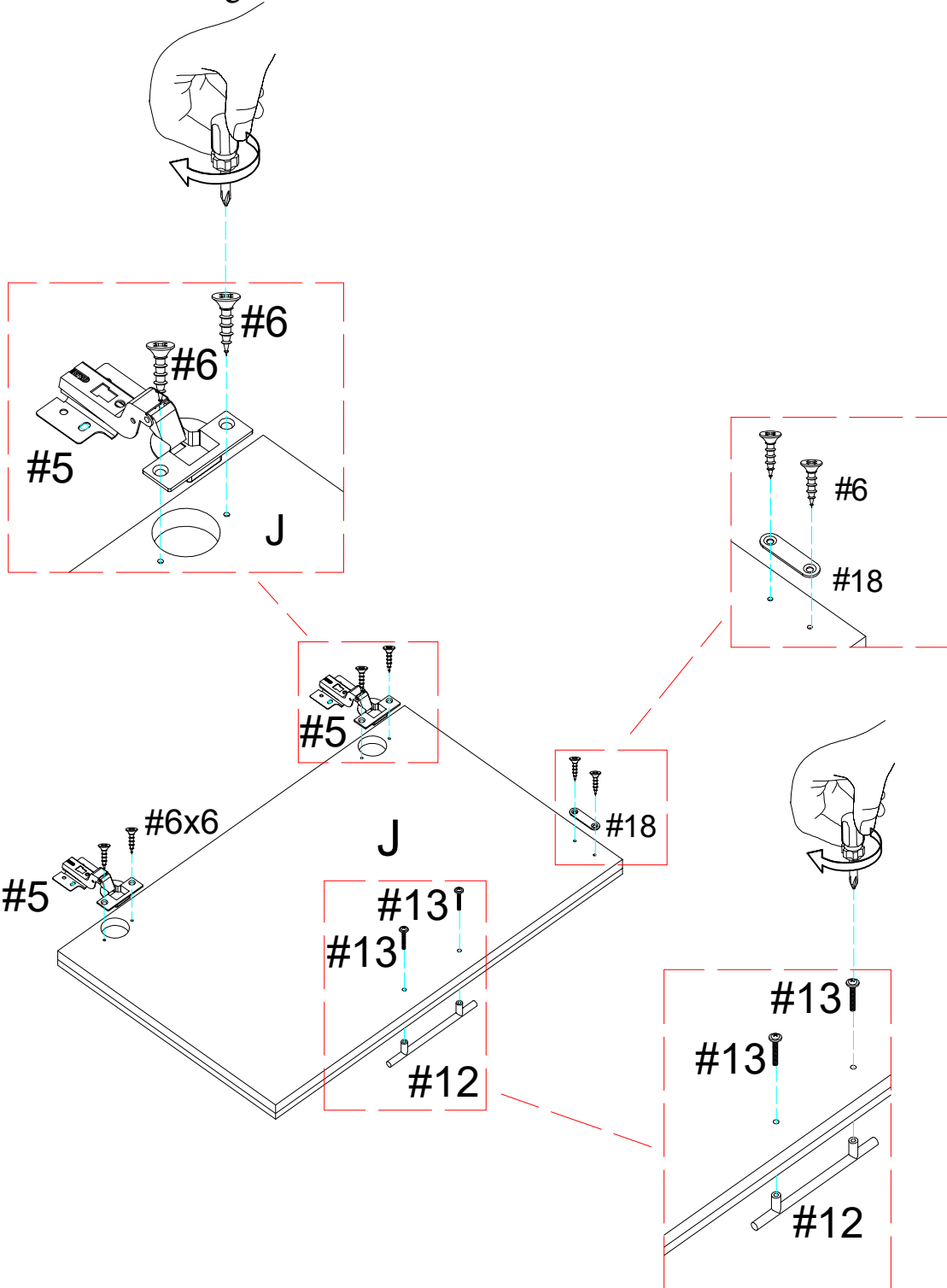

#5	X2

#6	X6
M3.5x14mm	

#12	X1
150mm	

#13	X2
M4x18mm	

#18	X1

#20	X1

ASSEMBLY INSTRUCTIONS

STEP-12

Use screw #6 to attach right door G and J to pre-assemble unit at step 10 ,tighten screw #6 with screwdriver #20

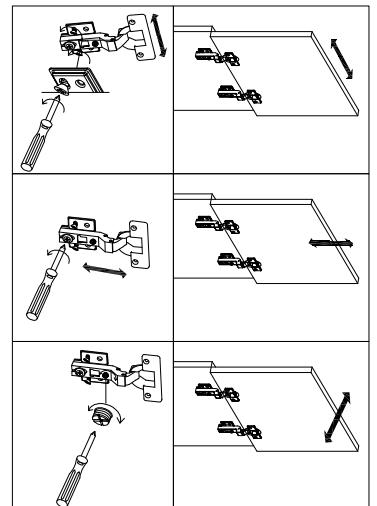
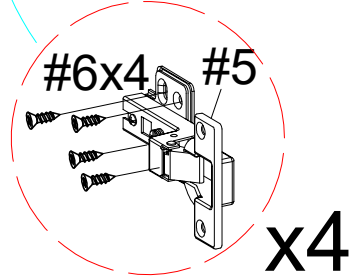
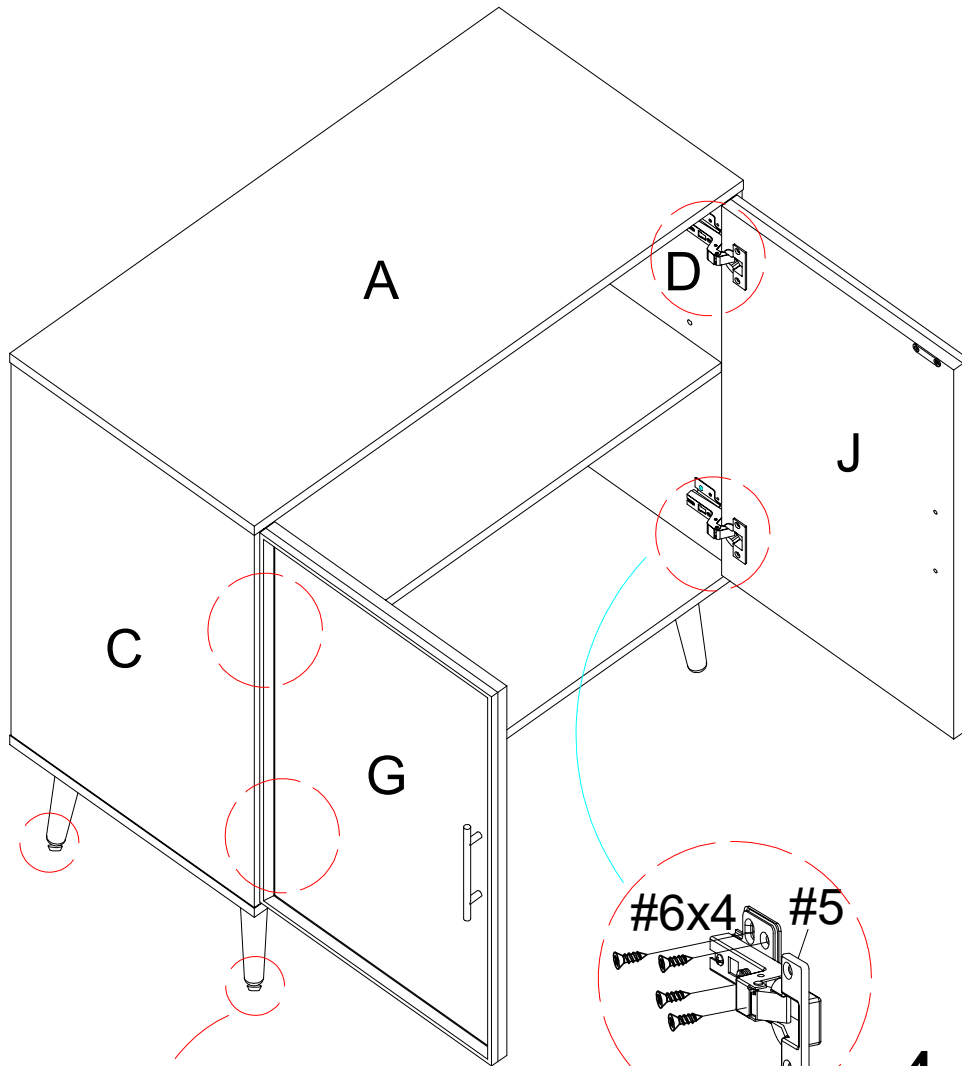

Attention
Before the next step adjust the feet of the locker to keep it level.

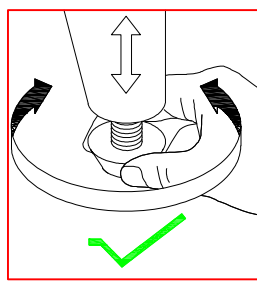
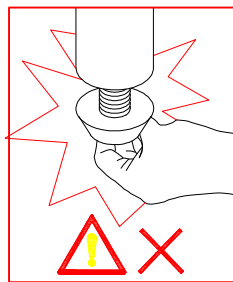

#6	x16
	
M3.5x14mm	

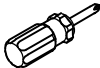
#20	x1
	

ASSEMBLY INSTRUCTIONS

STEP-13

Concealed hinges are three-way adjustable

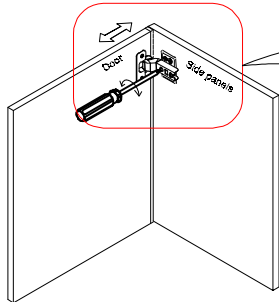

Horizontal
by screw adjustment!

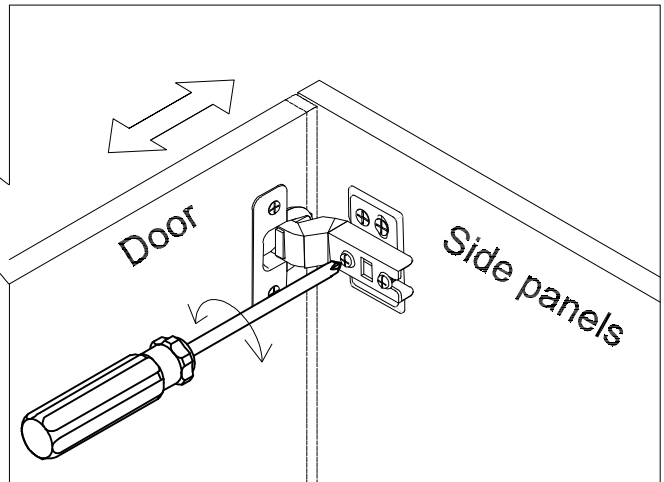

Concealed hinges are three-way adjustable

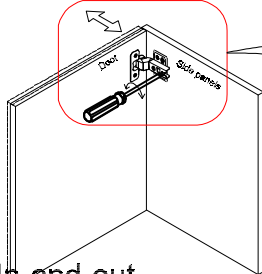

In-and-out
by loosening the hinge arm
mounting screw or via cam
adjustment!

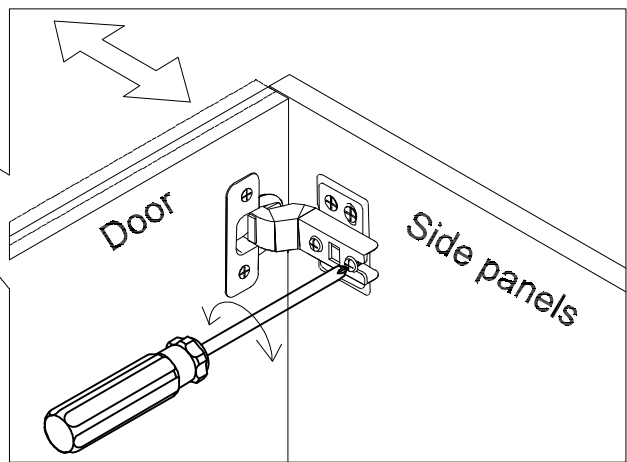

Concealed hinges are three-way adjustable

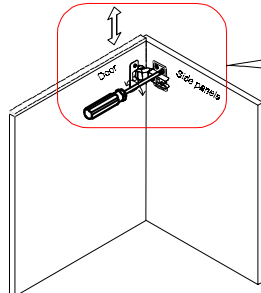

Vertical via slots in
the mounting plate
or via cam adjustment!

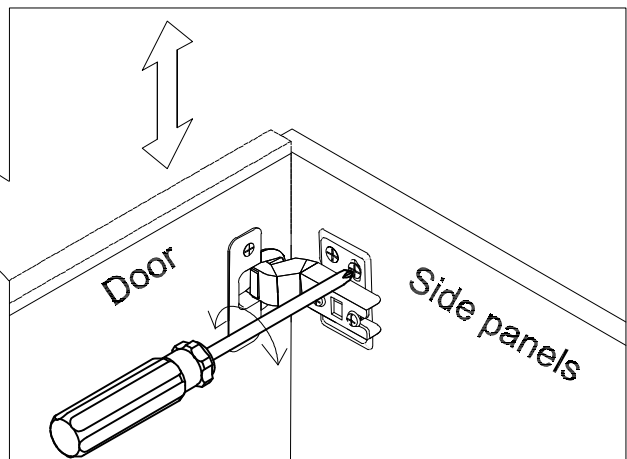



Hinge adjustment method

ASSEMBLY INSTRUCTIONS

STEP-14

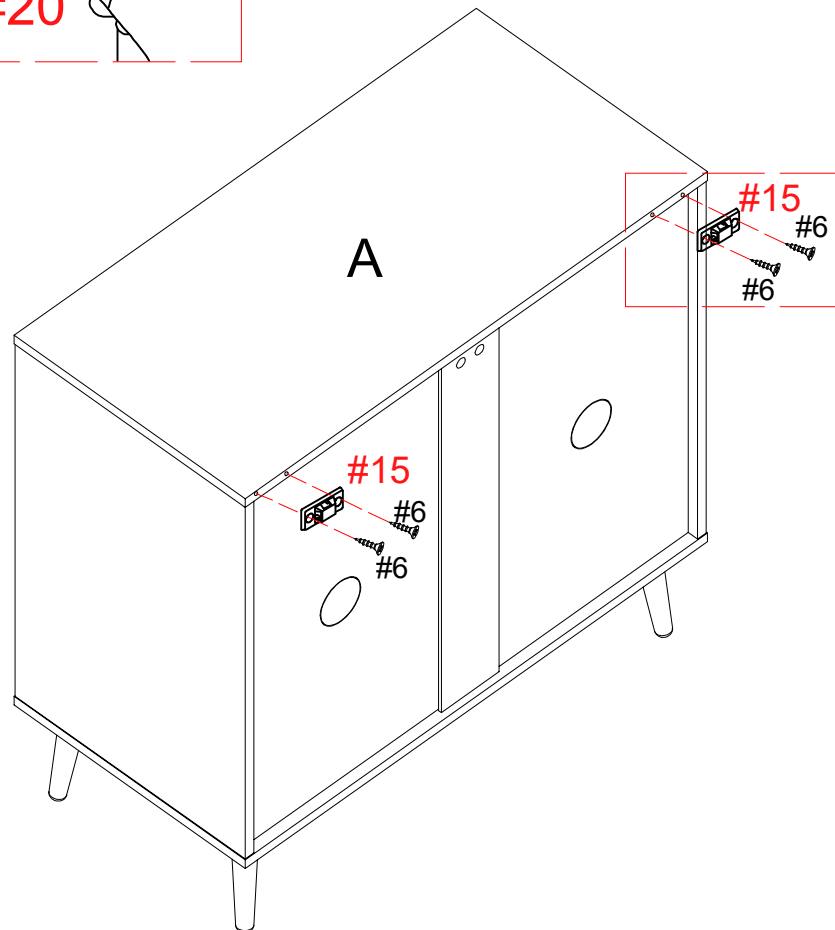
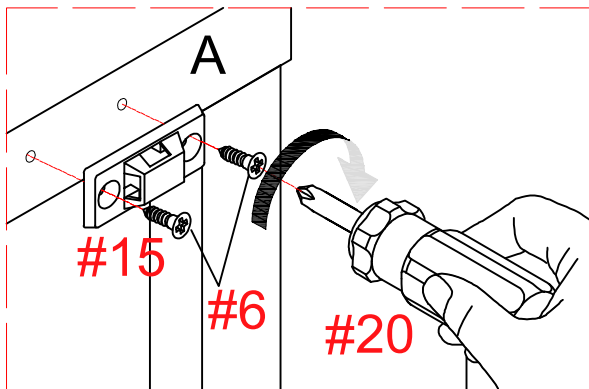
Attach part #15 to parts A, C with bolt #6 and tighten the bolt with screwdriver #20.



#6	x4
	
M3.5x14mm	

#15	x2
	

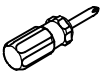
#20	x1
	

ASSEMBLY INSTRUCTIONS

STEP-15

Mark the position on the wall, that corresponds to the location of part #15 on the side panel A; Drill and insert the expandable screw #14 by hammer. Assemble the part #15 to the wall. Align the hole in the part #15 with the expandable screw #14, use screw #7 to attach it and tighten by screwdriver #20

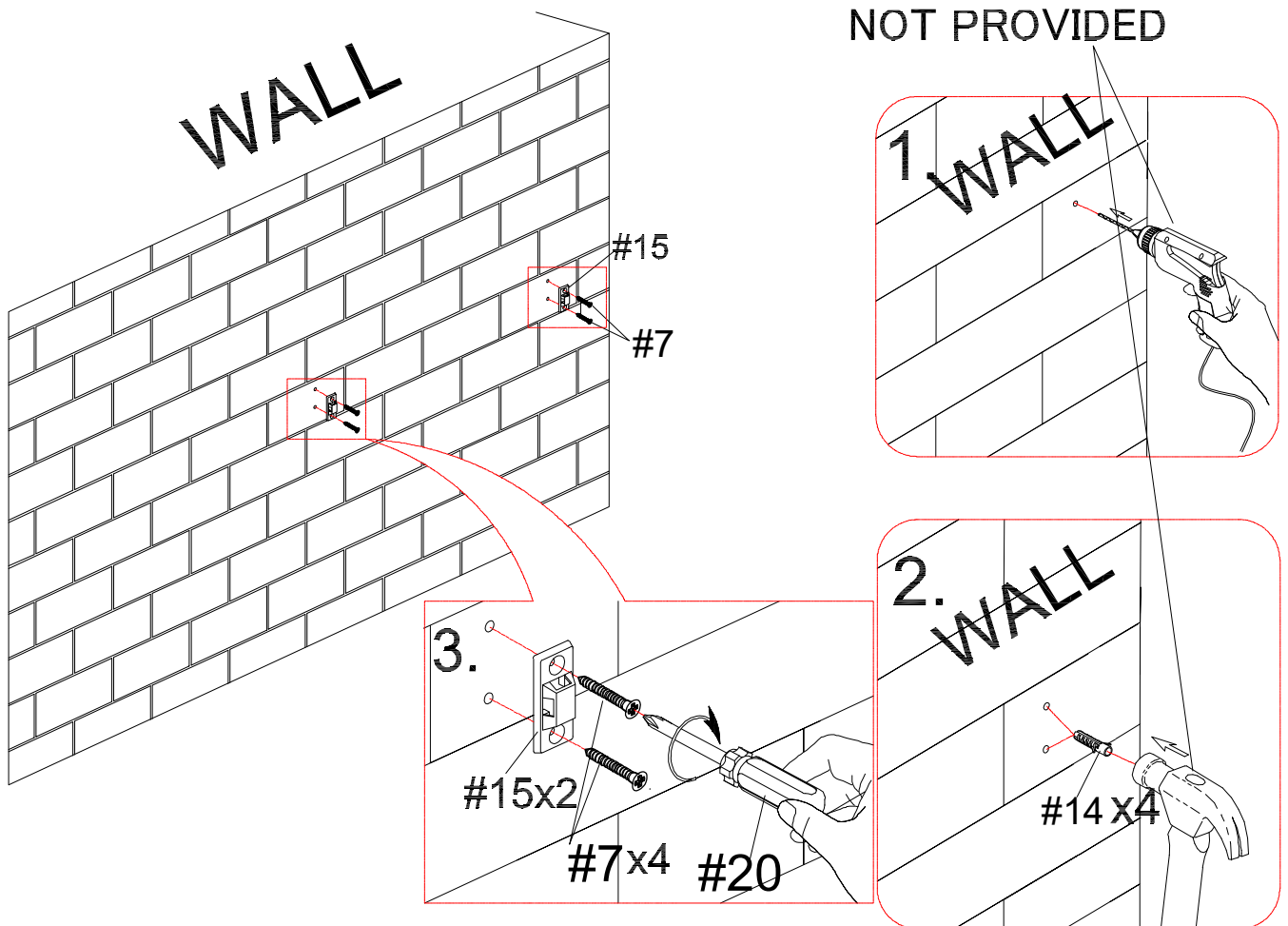

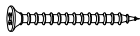
#7	X4
	
M4x35mm	

#14	X4
	

#15	X2
	

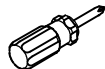
#20	X1
	

ASSEMBLY INSTRUCTIONS

STEP-16

Let the plastic belt #16 pass through the both part #15 and pull tightly.

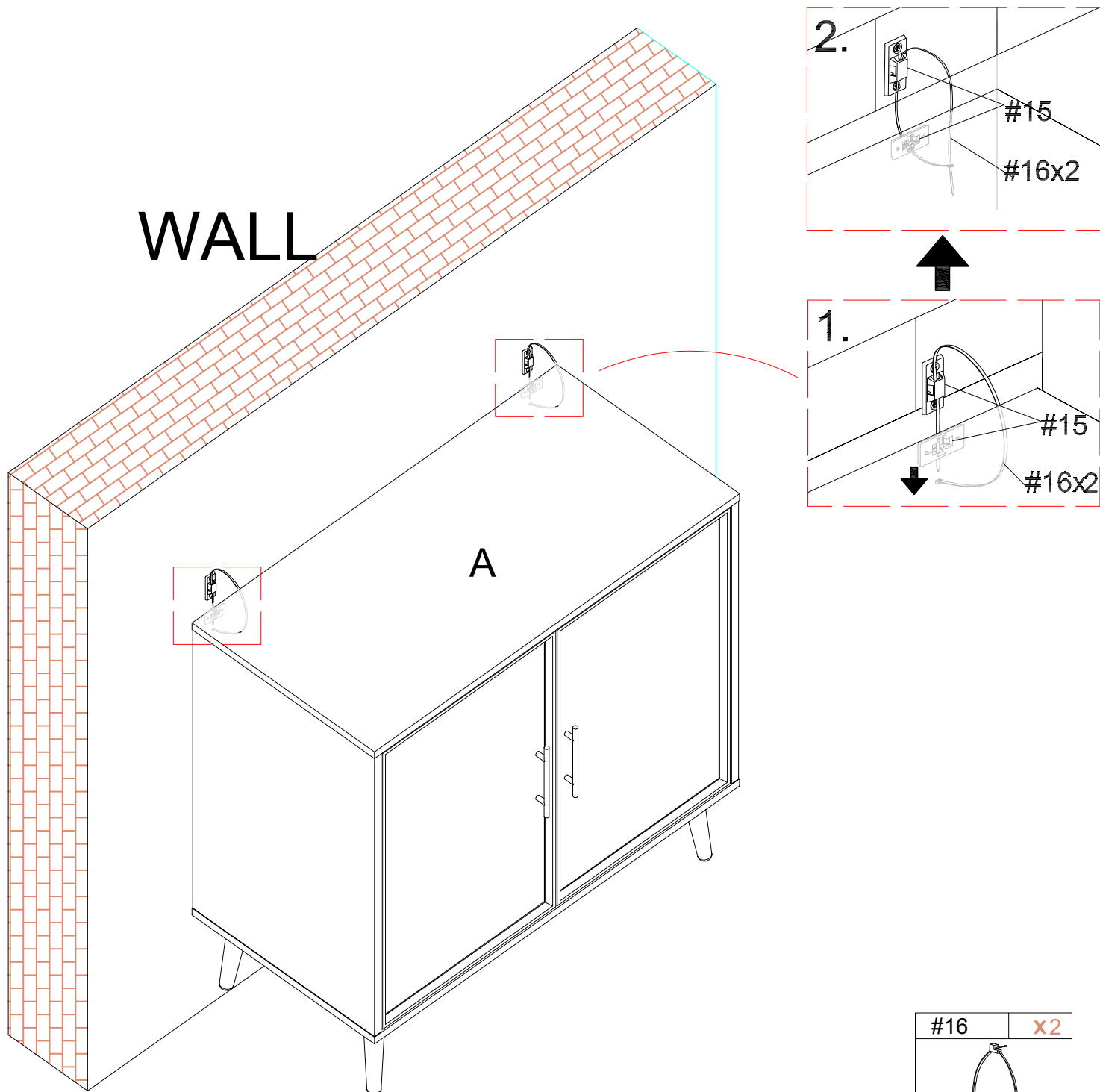

#16	x2

WARRANTY

1. We strive to offer high-quality products, and we also try our best to satisfy each and every customer that orders from us with product or service as needed.
2. We provide 30 days warranty starting from the time you receive the item. Each customer must provide a record of their order such as the order number, or item receipt for any items that are out of the warranty period you may also still receive.
3. Replacement parts by purchasing them with our company if they are available.