







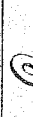

Assembly Instruction

Thank you for your purchase. Before discarding packaging material be sure you have located all the parts including the necessary hardware and tools listed on the instruction sheet below.
 Caution: Read before unpacking Assembly Parts. Sharp exposed staple tips can cause injury. For your protection, please remove any exposed staples used in packaging.

HARDWARE LIST

NO	DESCRIPTION	FIGURE	QTY
A	LONG BOLT		4PCS
B	MEDIUM BOLT		4PCS
C	SHORT BOLT		3PCS
D	FLAT WASHER		11PCS
E	SPRING WASHER		11PCS
F	ALLEN KEY		1PC

PARTS LIST

NO	DESCRIPTION	FIGURE	QTY
1	BACK FRAME		1PC
2	SEAT FRAME		1PC
3	LEG		2PCS

INSTRUCTIONS:

STEP 1. Assembly the Seat Frame (2) to Back Frame (1) with 4 long Bolt (A) and 3 short Bolt (C), 7 Flat Washer(D), 7 Spring Washer (E) and Allen Key (F).

STEP 2. Assembly the 2 Front Leg (3) to the Seat Frame with 4 Medium Bolt (B), 4 Flat Washer (D), 4 Spring washer (E) and Allen Key (F)

SEE THE ILLUSTRATION

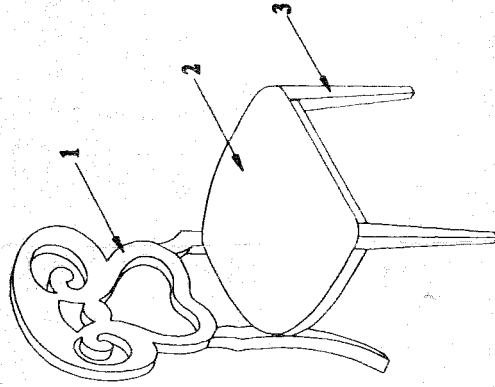

STEP 1

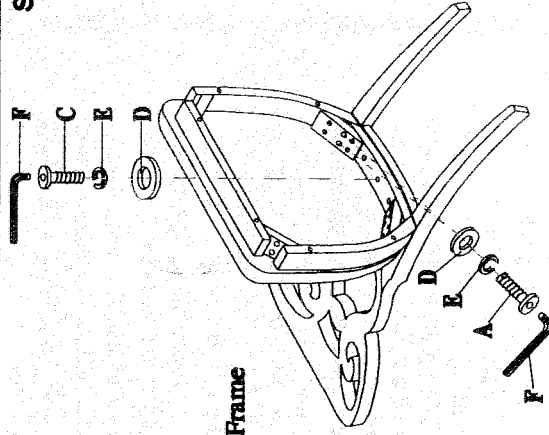

STEP 2

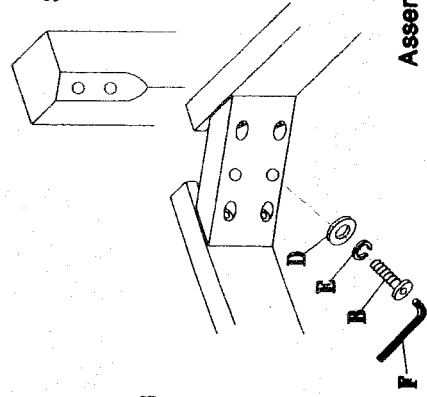

Thank you for your purchase .

Assembly is completed