

**MALFUNCTION ELIMINATES:**

Vehicle couldn't move	1. Check whether the power switch is off.
	2. Check whether the forward/backward switch is in the neutral gear (in the middle).
	3. Check the fuse is damaged, if so, change it.
	4. Check whether the battery wires are connected well?
	5. Charger's dc in the charging socket will make it not work, if so, take it out.
	6. Check whether stepped on the pedal.
	7. Check whether anything trapped in the wheels.
Vehicle move slowly	1. Check whether the battery be fully charged.
	2. Check whether anything trapped in the wheels.
	3. Check whether the vehicle is over loaded.
Vehicle cannot be charged	1. Check whether the charger or battery is damaged.
	2. Check whether the charger and the battery is well connected.
	3. The charger or battery if there is a loose connection.

**WARNING**

1. This note is to use illustrations to illustrate the operation of the product and product structure, there are a few differences, in kind prevail.  
 2. In order to improve the quality of the products, under the condition of without telling, we may make changes to the product part of the structure with the appearance, please understanding



- Suitable age 37-95 months.
- This product should be assembled by adult.
- This instruction contains important safety information content, please keep it as a reference.

**About the products**

Thank you for choosing our children electric car. We always keep pursuing being outstanding and designing comfortable and safe ride on car for children, and give your children a wonderful childhood.

Please read this instruction carefully before use, it will tell you the right way of assembling and operating. To avoid incorrect operations damaging the product or injuring your baby, please keep this instruction.

**Specifications**

Battery:	12V4.5Ah
Main material:	PP
Suitable age:	37-95 months
G.W:	20kg
N.W:	16kg
Car Size:	110x68x52cm
Package Size:	110x58x37cm
Speed:	3.5km/h
Operation time:	1-2 hours after charging about 8-12 hours
Charge:	Input AC220V, Output DC12V500mA
Fuse:	Resettable Fuse

**Part List**

No.	Part Name	Picture	Qty (pcs)	No.	Part Name	Picture	Qty (pcs)
1	Main body		1	2	Seat		1
3	Wind shield		1	4	Steering wheel		1

**MAINTENANCE**

1. Check the main parts regularly, check if there's any damage of the battery, charger, plug, cover and the other parts, check if the screws are tight, check if the wire lead is old. If any damage, please stop use and deliver to the professional service.
2. Clean the iron parts with little lubricating oil after a time of use to avoid rust.
3. Keep the car away from fire, avoid direct sunshine, always turn it up but not turn it over, put in dry place when not use, and do not dump the car. Keep the car inside door room or cover it with cloth when wet weather.
4. Keep the car away from hot objects like stove or heater, for the plastic might be melted, when charging, keep it away from flammable materials to avoid fire.
5. Charge in time after use, and do it by adult. When the car will be nor used for long time, ensure it be charger and charge once every 3 month to keep the battery life.
6. Clean the vehicle by dry soft cloth, do not use any chemical solvents, soap or water. Do not drive in raining or snowing days.
7. When stop using the car, cut off the power, turn all the buttons to "stop" or "off".
8. Do not use inconsistent fuse.
9. Do not change the line system, structure and additional electric system of the vehicle by yourself, repair work must be done by career man or under professional supervision.
10. Toy is not to be used for other purposes.
11. In the correct polarity in the battery.
12. It is forbidden to battery is negative short circuit.
13. The rechargeable battery can't charge.
14. Rechargeable batteries can only be charged under adult supervision.
15. The old and new batteries and different types of batteries cannot be mixed use.
16. Run out of batteries extracted from toys to properly handle, prevent children playing.

**WARNING: NOT TRAFFIC TOOL, TO KEEP SAFE, ADULT'S SUPERVISION IS REQUIRED.**

To avoid the fuse trip cause cut the power, please note the things as follows:  
 The max loading is 30kgs, do not over the loading.  
 Do not drag everything.  
 Do not let the water or other liquid touched the circuit, battery and other parts.  
 Never modify the structure and the electric circuit system.



**CHARGE**

- This product charge should by adult for safety.
- Before first use should open the seat, connect the lines (red to red, black to black) please charge at least 8-12 hours.
- The charging jack is on the fuel tank cap, the steps as follows:
- When drive slow, should charge 8-12 hours in time, can't be over 20 hours.

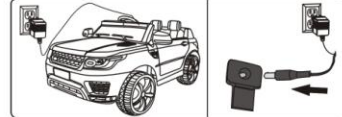

1. Insert the charger tap charging hole
2. Insert the charger to the power socket (The car won't start for charging status)

**NOTE:**

- Only Only can use the manufacturers specified battery and charger.
- The old and new batteries and different types of batteries cannot be mixed use.
- Do not open the battery and charger.
- Do not overturn the battery.
- Before charge, please confirm whether the charger battery and the jack are well, if damaged, stop use, until restored.
- When charging, the battery will be warm, it's regular or the battery maybe damaged.
- Must use the platen fasten the battery, the battery will hurt the children when the car overturn.
- The adult should bring out the battery proper recycling.
- When the car will be not used for long time, ensure it be charged and charge once every 3 month to keep the battery life.
- The charger is not toy, keep it away from the children.

No.	Part Name	Picture	Qty (pcs)	No.	Part Name	Picture	Qty (pcs)
5	Rear-view mirror		1	6	Rear wing		1
7	Driving wheel		4	8	Wheel Cover		4
9	Direction axis		1	10	Remote Control		1
11	Charge		1	12	Tool bag		1
13	Gear box		2	14	Instruction		1

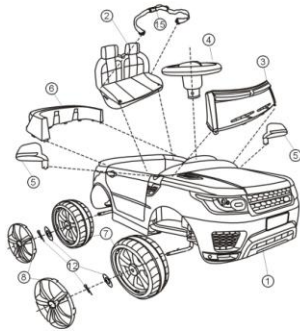

① Main body x1	⑥ Wheel Cover x4
② Seat x1	
③ Wind shield x1	
④ Steering wheel x1	
⑤ Rear-view mirrors x1	
⑦ Driving wheel x4	

### 2.4G Remote Control Manual

- First time use need to match code, this product has memory function  
 Replace battery is unnecessary match code
- Hold down "△" & "▽" keys for 3 seconds start match code, The first LED flicker
  - Turn on the car body power now, The first LED lit up, Match code Success
  - Remember 10 seconds not run will be standby, Press any key wake up
  - Keys caption: "△" Forward, "▽" Back, "◀" Left, "▶" Right, "S" Speed, "P" Brake.  
 Press "S" key set up speed, 1 led lit up is low speed, 2 leds lit up is medium speed, 3 leds lit up is high speed, Back a car is only low speed  
 Press "P" key hold the brake, All LED flicker



### WARNING

- When using the remote control, please keep less than 10m to the car.
- The remote control should be operated only by adult, keep it away from the children.
- Before use, please read the instruction carefully, and make the empty test, do not allow children drive before you know how to control.
- Do not use this product on road, water or other place with barrier.
- To avoid the circuit damage, please do not use the remote control in rain or other way might cause soaking.
- Do not mix new and old batteries or different batteries.
- When not use for a long time, please remove the battery in case it cause any damage to the circuit board and the remote control.
- Do not drop the remote control when using.
- Take care of the remote control do not lose it.
- If the remote control can work no far than 3m, it might because there's not enough battery, please replace the cell inside the remote control.

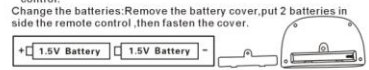

### FUSE

This product configure self-resetting fuse, when the driving car stopped, mainly because of the current exceeds the specified value, at this time, you should wait 5 seconds, then the fuse will automatic reset.

### HOW TO OPERATE YOUR VEHICLE

- Before use, must be confirm the product as follows:
    - According to the instruction assemble the car, connected well.
    - Make all the screws fastened tightly in the right place.
    - Before driving, parents should tell your children safety rules and make them understood.
- In order to reduce dangerous:
- Please sit on the seat when driving.
  - Only one child drive every time.
  - Driving must be under the adult supervision.
  - Note the driving in safe place, keep driving on hard and flat ground.
- DO NOT drive in dangerous places.
- ditch, pit, river side, slopes or other uneven ground.
  - Beside the road or other places for cars and people walking.
  - Barrier which might cause damage and injury.
  - Other dangerous places.
- Do not drive in black, it may cause injury. Do drive in day time or bright places.

### 2. OPERATE AS FOLLOWS

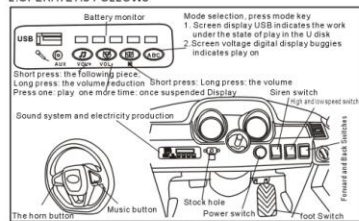

**Note:** Must tell your children, When change gears, release the foot switch, after the car stopped.  
 Do not change gears when the car is driving or damage the line and other parts.

### Assembling

- The vehicle should be assembled by adult before use.
- The small parts might cause choke, please keep away from the children. Children under 37 months can not use.
- Please check the number of the parts before assembling, and keep the packaging bags away from the children in case of choke.

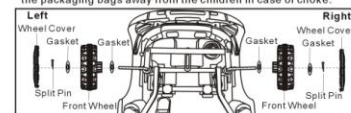

**1 Assemble the front wheel**  
 Turn over the car body. Fix the gasket, wheel, gasket onto the front axle from each side. Fasten tightly with the split pin, put on the wheel cover and cap.

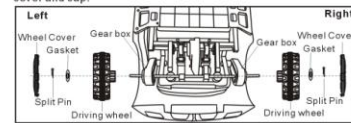

**2 Assemble the back wheel**  
 As showed in the picture, fix these parts onto the back axle. Fasten tightly with the split pin, put on the wheel cover and cap.

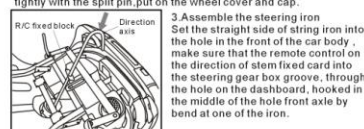

**3 Assemble the steering iron**  
 Set the straight side of string iron into the hole in the front of the car body, make sure that the remote control on the direction of stem fixed card into the steering gear box groove, through the hole on the dashboard, hooked in the middle of the hole front axle by bend at one of the iron.

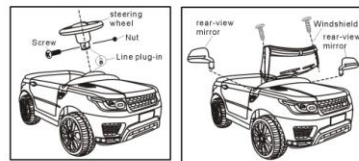

**4 Assemble the steering wheel**  
 Insert cable plug-in well first, then hold the steering wheel in the steering rod, fixed it by screws and nuts.

**5 Assemble the mirror**  
 Insert the mirrors into the hole on the car body tightly.

**6 Assemble the wind shielder**  
 Aim the wind deflector neck car body down on inserts, fix with two self-tapping screws on both sides

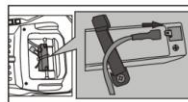

**7 Connect the power**  
 As showed in the picture, connect the motor plug-in with the car, then connect the power plug-in with the right direction.

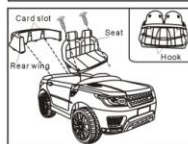

**8 Assemble the empennage and seat cushion**  
 buckle into the body corresponding to the position, fix the snap with the rock on the car body, then fasten by recoupy two self-tapping screws

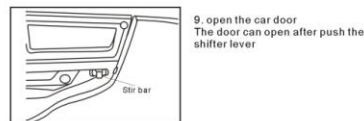

**9 open the car door**  
 The door can open after push the shifter lever

**Warning. Not to be used in traffic.**  
**WARNING:**  
**Must be assembled by an adult.**

### GIVE SAFETY EDUCATION BEFORE USE

- To avoid harmed by the little spare parts, less than 3years old can't drive.
- Assembled and charged Only by adult.
- The max loading is 30kgs, suitable for 3-8years old children. Do not over loading for safety.
- This product is not traffic tool, keep driving on hard and flat ground.
- Do not drive in the dangerous place, like street, road or sloap.
- Do not drive the mire or uneven places.
- Children should be instructed to the correct operation, to prevent the damage caused by improper operation, accident.
- When change gears, release the foot switch, after the car stopped.
- When driving, adult care and supervision is necessary. Do not leave and keep your child in your sight.
- Do not let the product in rain or other ways touch water, avoid damage the circuit and motor.
- Check whether the charger, plug-ins, and other parts are in good condition and well connected in time.
- To make sure safely and use longer, avoid damage the charger, battery or system, must be use the originals.
- When stop using the car, cut off the power, turn all buttons to "stop" or "off"
- The charger and battery of the products are not toy, forbidden.
- Do not use the spare parts not supply from us.
- The product mainly use PP, safety use time is 2years.