

ASSEMBLY INSTRUCTION

Thank you for purchasing this quality product. Be sure to check all packing material carefully for small parts, which may have come loose inside carton during shipment. Identify and count all parts and compare with the parts list below.

ASSEMBLY INSTRUCTION :

1. Remove hardware from box and sort by size.
2. Please check to see that all hardware and parts are present prior start of assembly.
3. Please follow attached instruction in the same sequence as numbered to assure fast and easy assembly

⚠ WARNING !

1. Don't attempt to repair or modify parts that are broken or defective. Please contact the store immediately.
2. This product is for home use only and not intended for commercial establishments.
3. Two persons are required for assembly.
4. Approximate assembly time : 1/2 hours.
5. Component parts and fittings contained in the box.
Please sort out all parts before you begin to assemble the item.
This is to make sure you always use the correct part .

6. It is **STRONGLY RECOMMENDED** that you **ANCHOR** this product .



Toppling furniture can cause serious injuries and death.

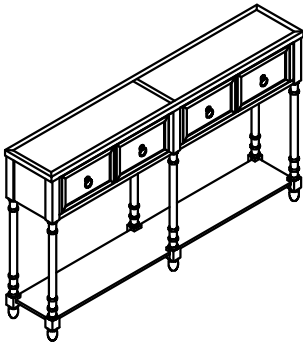

This product has not been fitted with an anchor strap.

To prevent your furniture from tipping forward it is strongly recommended

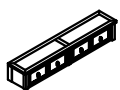
that you securely attach this product to a wall or other solid surface, using the anchor straps provided and appropriate fixings.

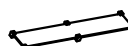

No.	Component	Q'ty
(A)	 Console Table	1
(C)	 Legs	6

No.	Component	Q'ty
(B)	 Shelf	1
(D)	 Stand Legs	6

Step 1

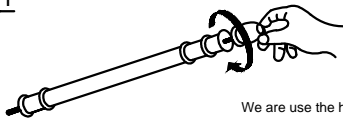

We are use the hands to turn the base of the legs cabinet counterclockwise

Step 2

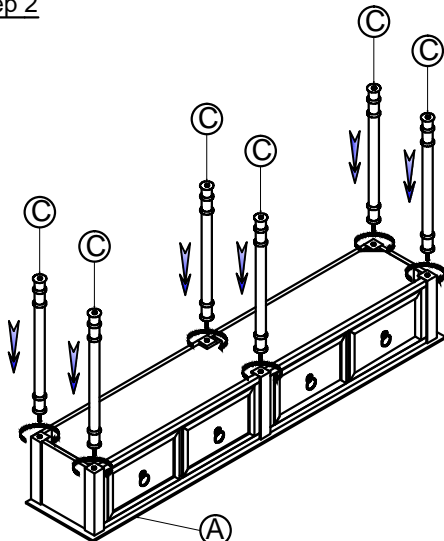

Step 3

