

## Use and Safety

### During Use:

- Perfect for patio setting and holds 50lbs of sand. Other weight bearing materials may be used. Not recommended are any wet materials or water.
- Base tube will accept any umbrella with up to a 2" pole.

### Safety After Use:

- Do not stand on side table stand.
- Remove umbrella when moving the table.
- Place in a cool dry place, or use a protective cover (**sold separately**) to prevent damage caused by exposure to the elements outdoors.
- Remove weight from the table when moving.

## Side Table Stand

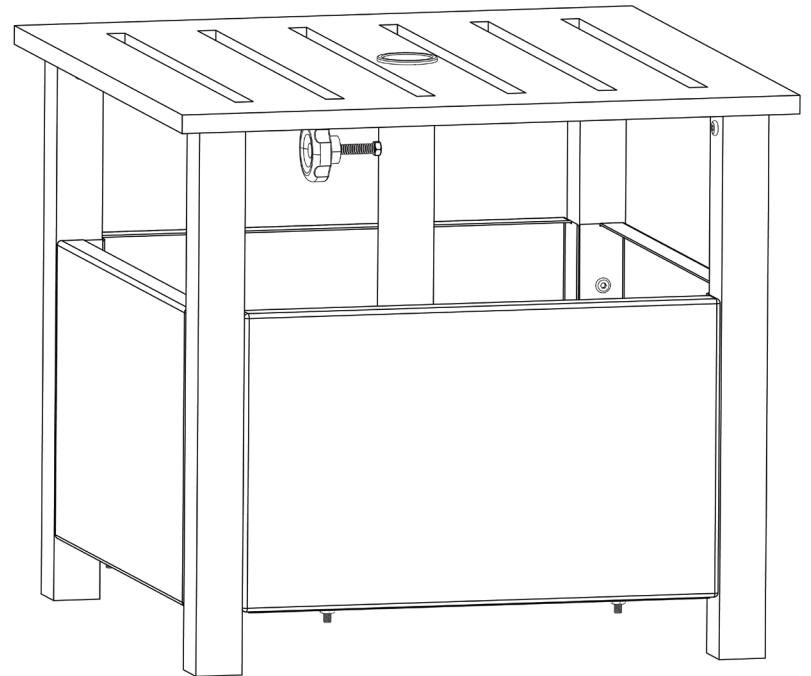

## Safety and Instructions

# Assembly

PLEASE READ THESE INSTRUCTIONS CAREFULLY BEFORE ASSEMBLY

Thank you for purchasing our product! We hope you enjoy many years of safe and useful ownership. Please see below for instructions on assembly of your new **Umbrella Stand**.

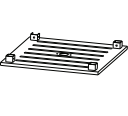
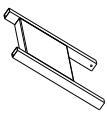
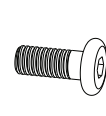
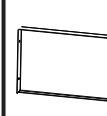
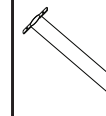
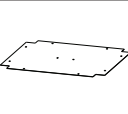
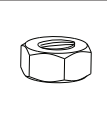
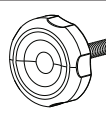
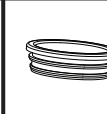
				
<b>A</b> 1 pcs	<b>B</b> 2 pcs	<b>C</b> 28 pcs	<b>D</b> 2 pcs	<b>E</b> 1 pcs
				
<b>F</b> 1 pcs	<b>G</b> 10 pcs	<b>H</b> 1 pcs	<b>I</b> 1 pcs	

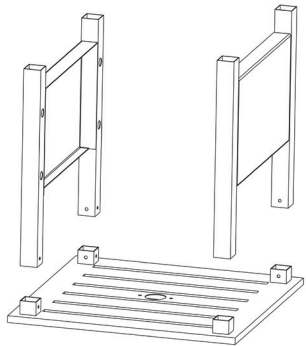

## One:

On a flat stable surface, place part A upside down. Place part B upside.

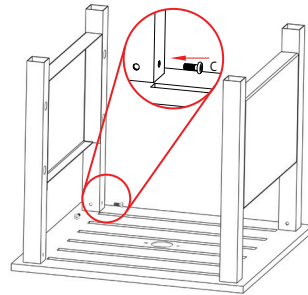

## Two:

Use 8 of part C to secure part B to part A.

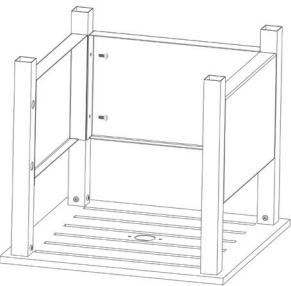

## Three:

Place part D aligned within the space between part B's, and attach using 4 of part C.

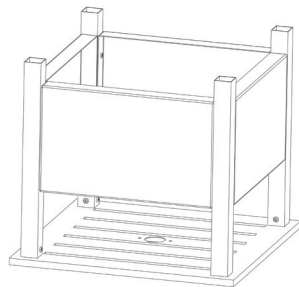

## Four:

Repeat Step 3 with remaining part D.

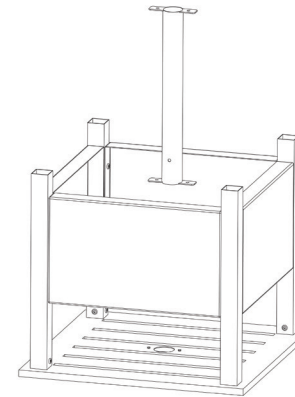

## Five:

Carefully place part E to part A

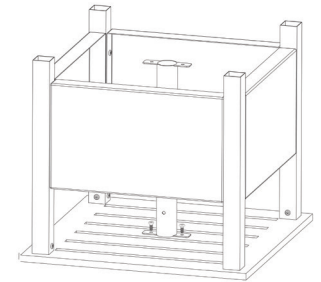

## Six:

Fasten part E to part A with 2 of part C.

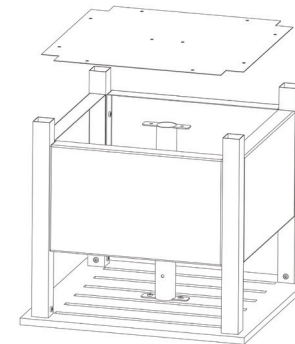

## Seven:

Attach part F to the completed part B using 10 of part C.

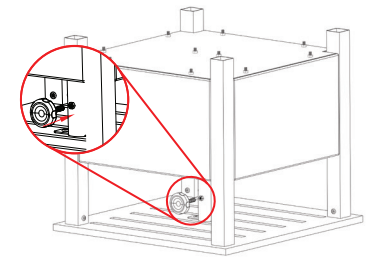

## Eight:

Take part H and screw into part E.

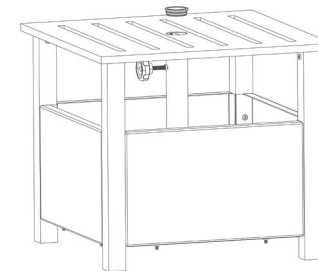

## Nine:

Lastly, flip the entire unit over and finish by placing in part I. Once completed it is ready to use.