

WARNING

- * Switch off the main electrical supply from the main fuse box / circuit breaker before installation.
- * Inspect item carefully before attempting to install.
- * If there is any damages or obvious defects, do not install.
- * Item may not be returned once it has been installed.













CARE AND MAINTENANCE

- * To clean the outside of the fixture, use a dry or slightly dampened clean cloth (use clean water, never a solvent) to wipe the surface of the fixture.
- * To clean the inside of the fixture, first disconnect power to the fixture by turning off the circuit breaker or by removing the fuse at the fuse box. Next, use a dry or slightly dampened clean cloth (use clean water, never a solvent) to wipe the interior surface of the fixture.
- * Do not use any cleaners with chemical, solvents or harsh abrasives. Use only a dry soft cloth to dust or wipe carefully.

NOTICE& IMPORTANT SAFETY INSTRUCTIONS

- ** WE RECOMMEND INSTALLATION OF THIS LIGHTING FIXTURE BE DONE BY A LICENSED ELECTRICIAN **
 - * Please make sure that you have all parts indicated before you begin assembly of this item
 - * This item should be assembled on a soft surface to prevent scratching the finish during assembly
 - * To reduce the risk of fire, electrical shock or injury to persons or property, please follow the guideline below for safe use and installation
 - *The external flexible cable or cord of this lamp cannot be replaced
- If the cord is damaged, the lamp shall be destroyed

Part List and Hardware List

PIECE	DESCRIPTION	PICTURE	QUANTITY	PIECE	DESCRIPTION	PICTURE	QUANTITY
A	machine screw		2X	H	Light body		1X
B	Mounting Screw		2X	I	Long iron pipe		2X
C	mounting bracket		1X	J	Short iron pipe		2X
D	ground screw		1X	K	Glass		1X
E	wire connector		3X	L	Lamp cup		1X
F	canopy nut		2X	M	Bulb		1X
G	canopy		2X	M	Bulb		1X

Owner Manual

Product Dimensions: 14"Lx14"W x 52.5"H

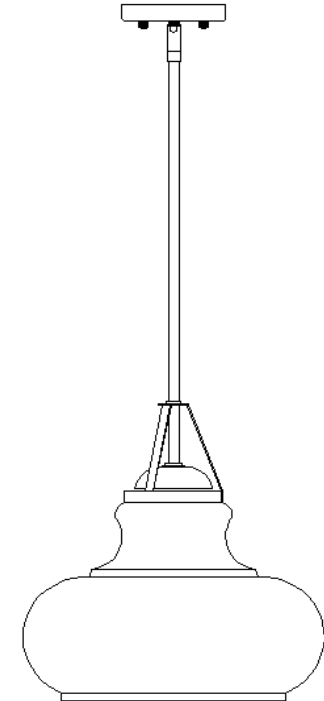

PREPARATION

- * Before beginning assembly of product, make sure all parts are present. Compare parts with package contents list and hardware contents list.
- * If any part is missing or damaged, do not attempt to assemble the product.
- * Estimated Assembly Time: 30 minutes.
- * If you are having difficulty, our friendly Customer Care team is always here to help.

NOTE: PLEASE USE TYPE "A" BULB MAX 40-WATT OR LED BULB MAX 5-WATT, THERE IS LED 4-WATT BULB IN THE BOX

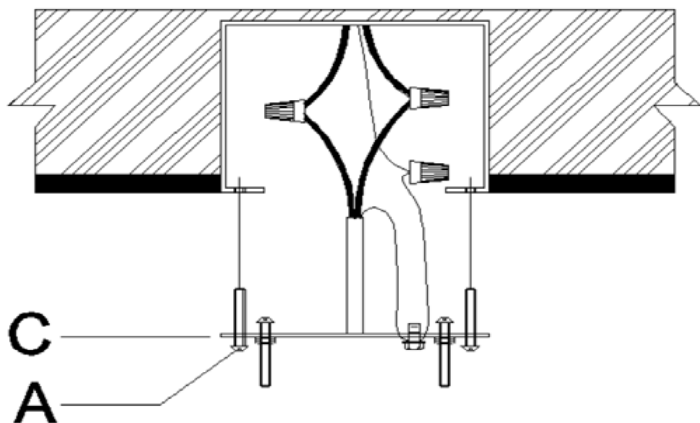

Step 1:Unpack all parts from cartons carefully. Fix the Mounting plate (C) to the junction box with machine screw (A)

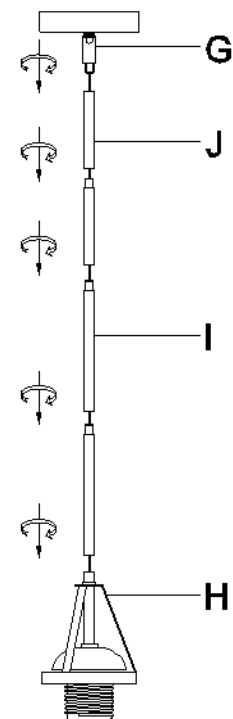

Step 2:The long iron pipe (I) and short iron pipe (J) can be selected as required, the lamp cap wire on the lamp body (H) can be passed through in turn, and fixed by rotation, and then the canopy (G) can be fixed on the long iron pipe (I) or short iron pipe (J) by rotation

PREPARATION

- * Before beginning assembly of product, make sure all parts are present. Compare parts with package contents list and hardware contents list.
- * If any part is missing or damaged, do not attempt to assemble the product.
- * Estimated Assembly Time: 30 minutes.
- * If you are having difficulty, our friendly Customer Care team is always here to help.

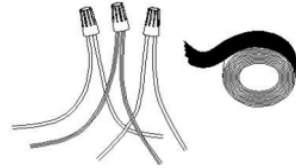
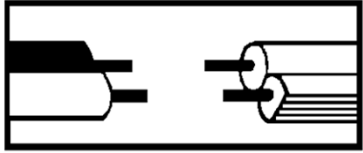

Step 3: Wire connection

Connect fixture neutral wire (ribbed) to the outlet box neutral wire (usually white) using a wire nut.

Connect fixture hot wire (smooth with markings) to the outlet box hot wire (usually black) using a wire nut.

CAUTION: Do not reverse the hot and neutral connections

Grounding Instructions:

Wrap ground wire from outlet box around green ground screw on mounting bracket, no less than 2" from wire end. Tighten ground screw. If fixture is supplied with a ground wire, connect to outlet ground wire with a wire nut.

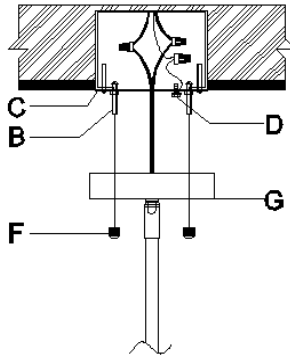

Step 4: Attach the canopy (G) to the Mounting Plate (C), and fix it by turning the canopy nut (F) anti clockwise

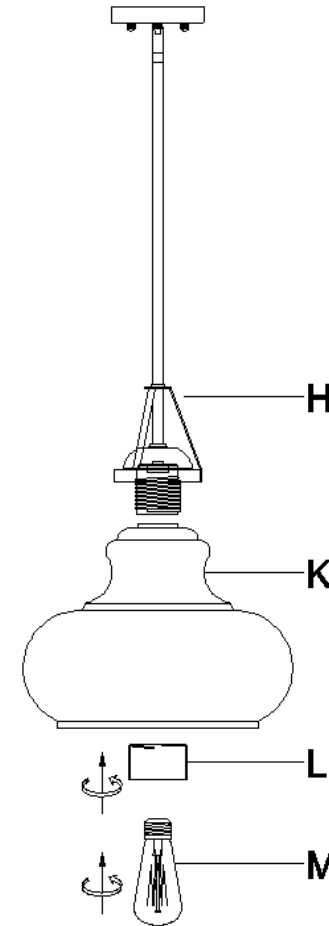

Step 5: Fix the glass (K) to the lamp holder of the lamp body (H) using a lamp cup (L), and then fix the bulb (M) on the lamp holder