

Assembly instructions for the ottoman, including tool requirements, time, and personnel.

Tools: A screwdriver is shown as required, and a power drill is shown as not required.

Time: 15 minutes.

Personnel: 2 people.

Warnings: Two warning triangles with exclamation marks are present, one above the tools section and one above the personnel section.

A

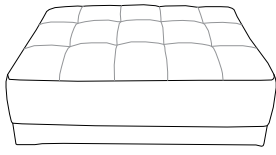

x 1

B

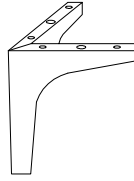

x 4

C

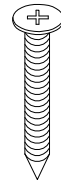

5
x
25

x 16

A

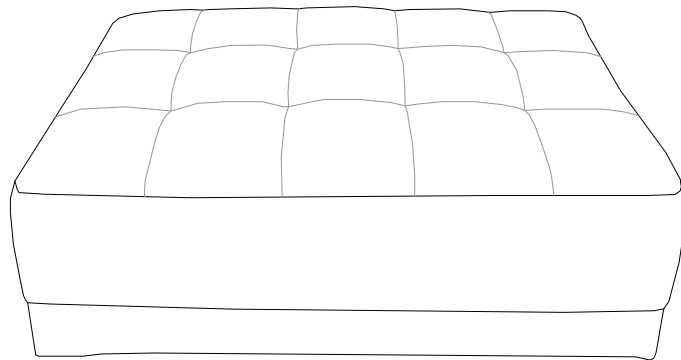

B x 4

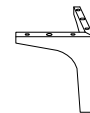
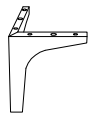

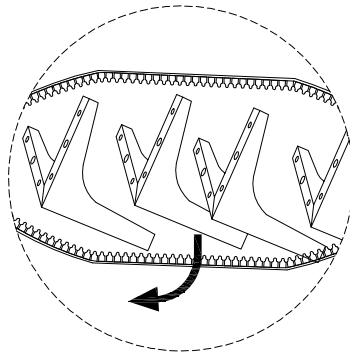
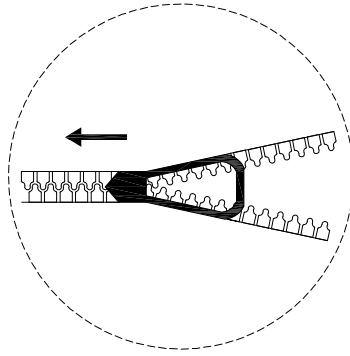
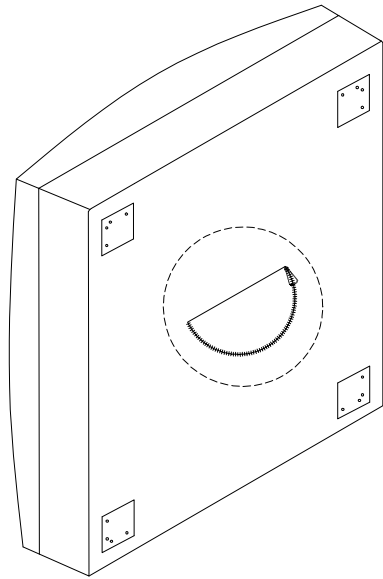

1

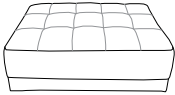
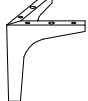
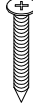
<p>A</p>  <p>x 1</p>	<p>B</p>  <p>x 4</p>	<p>C</p>  <p>5 x 25</p> <p>x 16</p>
--	--	---

