

Assembly Instructions

Caution : You must read this before you proceed.

LOUNGER

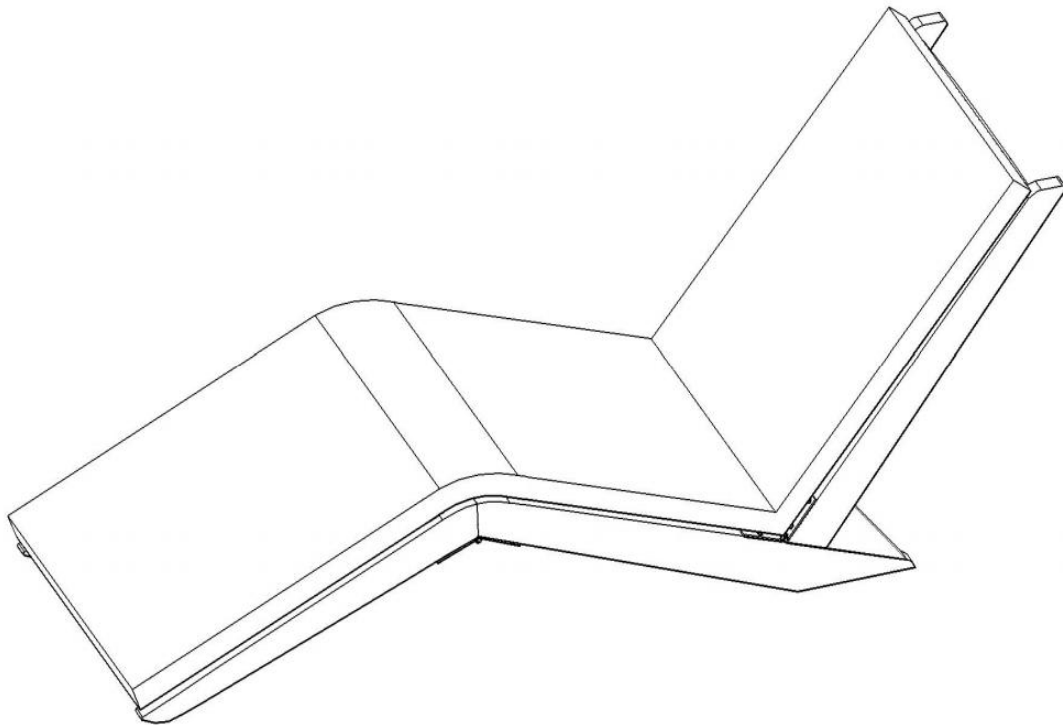

CAUTION This Sun Lounger is NOT a TOY.
This Lounger is intended as a ONE person Lounger.
DO NOT SIT at the TOP of the Backrest.
DO NOT exert pressure and or weight to the top of the backrest.
Keep your child / children at bay in the process of manual

Manual Preparation

Before Beginning Manual:

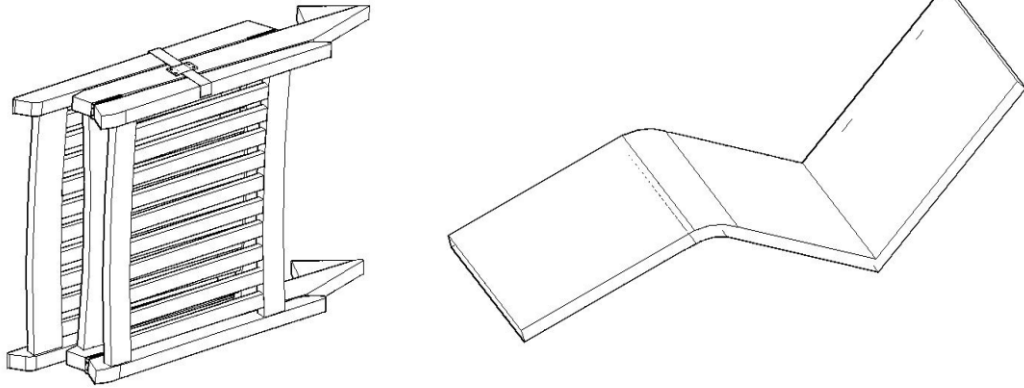

- Read instructions, cover to cover-
- Have 2 adults on hand for assembly-
- Do not assemble on flooring or carpet-
- Assemble on a clean non-marring surface (packing foam)-
- Save all packaging until finished-

Manual Steps

Step 1

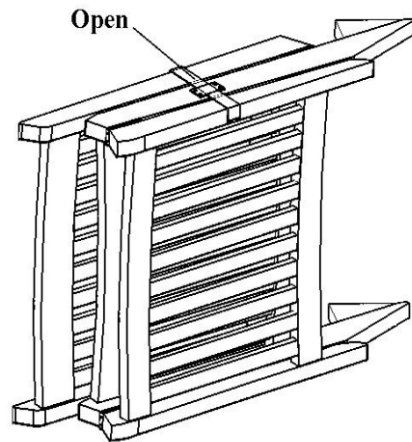

Unpack and place the Lounger on its side & unbuckle the strap-belt.

Step 2

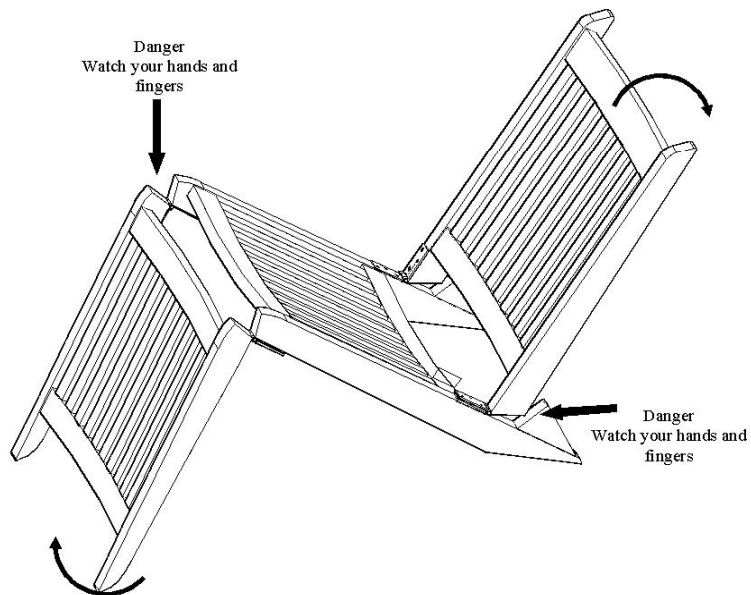

Still on its side, gently unfold each part of the Lounger following the arrows as shown in the picture.

This Lounger is slightly heavy, do exercise caution to avoid injury.

Step 3

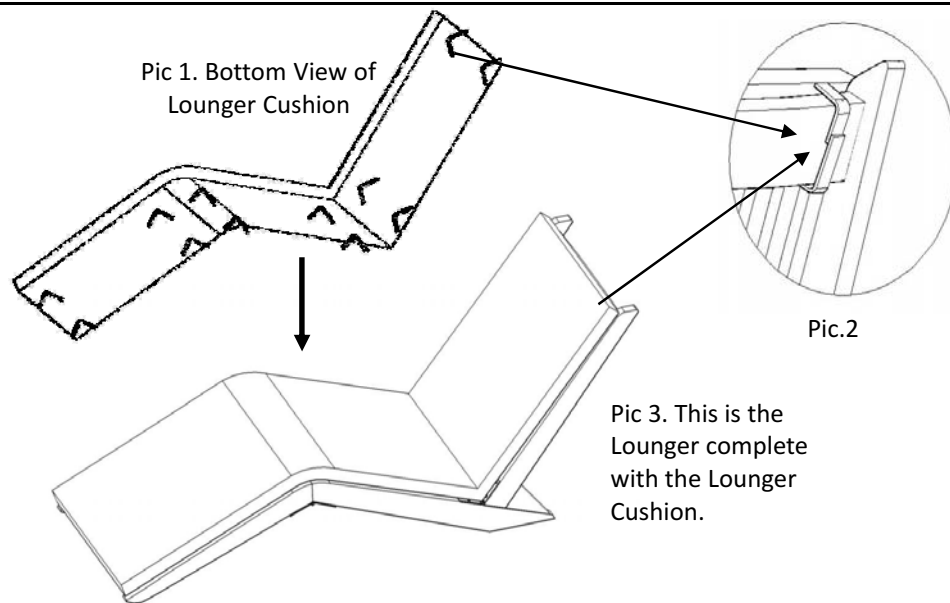

Pictured above (Pic. 1), you can see the Lounger Cushion has 12 tiebacks. It is recommended to secure the tiebacks to the Lounger whilst the Lounger is still on its side.

Put on the Cushion and fit 12 Cushion's ties to the Lounger as shown in the picture above, (Pic. 2).

Upon completion of the Lounger Cushion - see Pic. 3.



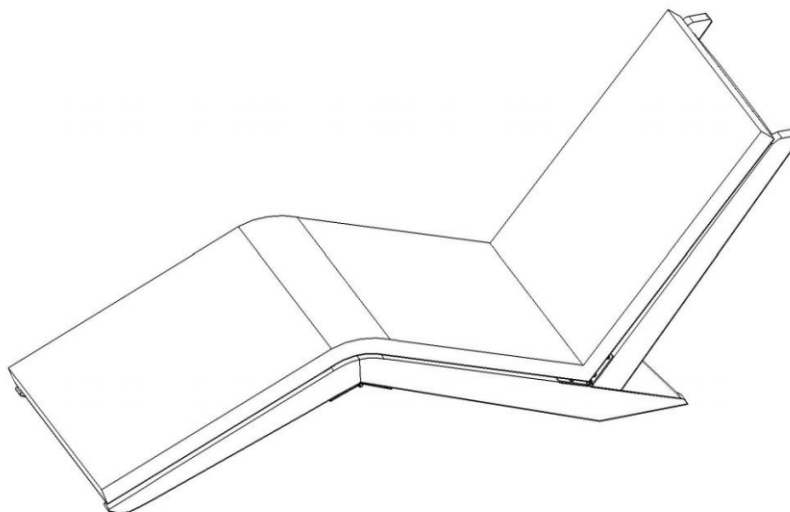





Step 4



Your Lounger is now ready for use.

Recommendation : When the Lounger is not in use, store the Lounger Cushion in a dry cool place.

Care & Maintenance

-  • Do not put hot items directly on furniture surface.
-  • Do not clean furniture with harsh cleansers or polish.
-  ✓ • To obtain the longest lifespan of your outdoor products, minimizing exposure to direct sunlight is recommended.
-  • Children should not climb or jump on the furniture.
-  • Do not write on furniture without a padded barrier to protect the surface.
-  ✓ • To obtain the longest lifespan of your outdoor products, avoid extended and lengthy exposure to rain, snow, and direct sunshine. Whenever possible cover the product and /or place under patio or awnings.
-  • Not for commercial use. For residential use only.
-  • Stains may be removed with mild soap solution and damp cloth.
-  ✓ • Dust and pick-up spills using a clean, non-colored, lint-free cloth .

Questions & Answers about Proposition 65

- What is Proposition 65?

Proposition 65 requires businesses to provide warnings to Californians about significant exposures to chemicals that cause cancer, birth defects or other reproductive harm. These chemicals can be in the products that Californians purchase, in their homes or workplaces, or that are released into the environment. By requiring that this information be provided, Proposition 65 enables Californians to make informed decisions about their exposures to these chemicals.

Proposition 65 also prohibits California businesses from knowingly discharging significant amounts of listed chemicals into sources of drinking water.

Proposition 65 requires California to publish a list of chemicals known to cause cancer, birth defects or other reproductive harm. This list, which must be updated at least once a year, has grown to include approximately 900 chemicals since it was first published in 1987.

- What types of chemicals are on the Proposition 65 list?

The list contains a wide range of naturally occurring and synthetic chemicals that include additives or ingredients in pesticides, common household products, food, drugs, dyes, or solvents. Listed chemicals may also be used in manufacturing and construction, or they may be byproducts of chemical processes, such as motor vehicle exhaust.

- What does a warning mean?

If a warning is placed on a product label or posted or distributed at a workplace, a business, or in rental housing, the business issuing the warning is aware or believes that it is exposing individuals to one or more listed chemicals.

By law, a warning must be given for listed chemicals unless the exposure is low enough to pose no significant risk of cancer or is significantly below levels observed to cause birth defects or other reproductive harm.

- Where can I get more information on Proposition 65?

If you have specific questions on the administration or implementation of Proposition 65, you can contact OEHHA's Proposition 65 program at P65.Questions@oehha.ca.gov, or by phone at (916) 445-6900.