

ASSEMBLY INSTRUCTIONS

TOOLS REQUIRED



Allen Wrench

(Included)



Phillips Screwdriver

(Not Included)

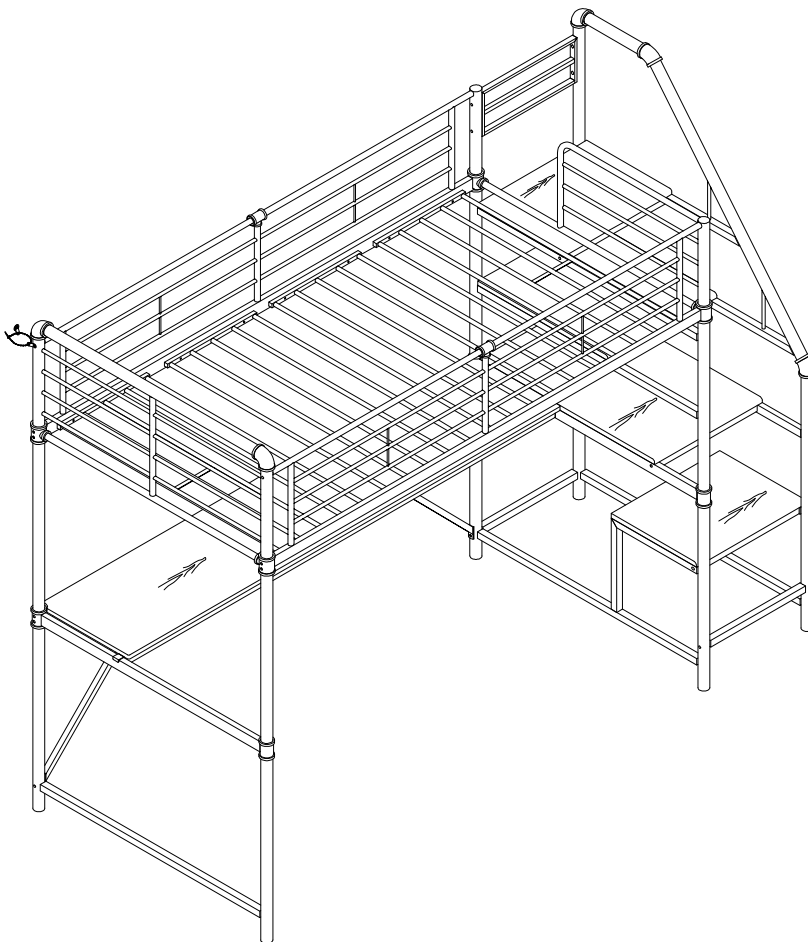

3 - People
Recommended

ASSEMBLY RATING



EASY → DIFFICULT

The Assembly Rating is a 5-point system showing the level of effort needed to assemble a specific product.



FOA Intro

Thank you for your purchase!

We hope you enjoy this new addition to your home for many years to come.

Our commitment to providing quality products does not simply end when you purchase our product. We fully stand behind our products from start to finish. Our customer service department is available Monday – Friday 8:30 AM – 5:30 PM Pacific Time and can help with assembly questions as well as, if necessary, replacing damaged or missing parts. To help expedite our service, please have these assembly instructions readily available, along with your order receipt.

 **Consumer Hotline**
Toll-Free 1-888-980-5122

 **Monday to Friday**
8:30AM- 5:30PM (PT)

 **WEBSITE**
www.foagroup.com

 **E-MAIL**
cs.ec@foagroup.com

    foagroup

 FurnitureOfAmerica

CHECK BEFORE STARTING

Are you missing anything?
Double-check all parts, hardware and accessories listed are all accounted for.

Check out our Quick Tips!
We recommend reviewing the pre-assembly handouts. Even experts need a refresher now and then!

Should we send any replacements?
Are there any irregularities or flaws in the parts? We can send replacements!

Prep Time!
Please review the assembly instructions and all diagrams prior to assembling.

PRE ASSEMBLY INTRODUCTION

We understand building ready-to-assemble furniture can be a challenging experience for some. To help avoid confusion, we have provided some helpful tips that may speed up the process.



Teamwork

ALWAYS have at least two people to help with transporting and assembling the product to avoid potential injury and/or damage.



Suitable Location

Assembling near the area of the intended location is highly recommended.



Sufficient Space

Make sure you have enough space to move around during the assembly.



Avoid Scratches

Use cardboard, blankets or a carpeted area while assembling furniture to prevent to prevent scratches and damages.



Flat Surface

Make sure the furniture rests on a flat and level surface with each leg evenly touching the floor.

ASSEMBLY AND CARE ADVICE



FAILURE TO FOLLOW THE GUIDELINES BELOW MAY RESULT IN INJURY AND/OR PROPERTY DAMAGE.



Position each part correctly and insert screws or bolts into their respective holes.



Turn clockwise to tighten and only tighten when step is completed or when instructed to do so.



Use the appropriate hand tools or power tools for assembly. Select steps, such as tightening screws and/or bolts, may require hand tools to avoid causing damage during assembly.



Save the instructions and store any supplied tools for later maintenance.

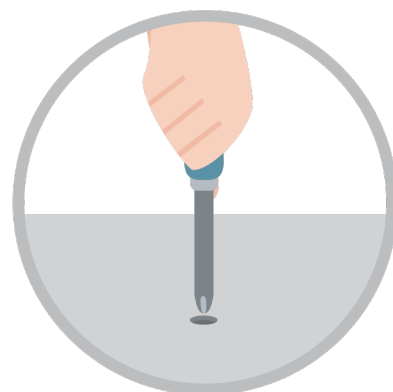

After two weeks, check and tighten any loose hardware and repeat again every six months thereafter.

IT IS THE USER'S RESPONSIBILITY TO MAINTAIN THE FURNITURE. THE HARDWARE MAY LOOSEN OVER TIME AND MAY CAUSE THE FURNITURE TO BE WOBBLY AND UNABLE TO SUPPORT ITS INTENDED WEIGHT CAPACITY. THIS MAY LEAD TO COLLAPSE AND MAY CAUSE SERIOUS INJURY.

Metal Twin size workstation loft bunkbed

CM-BK657

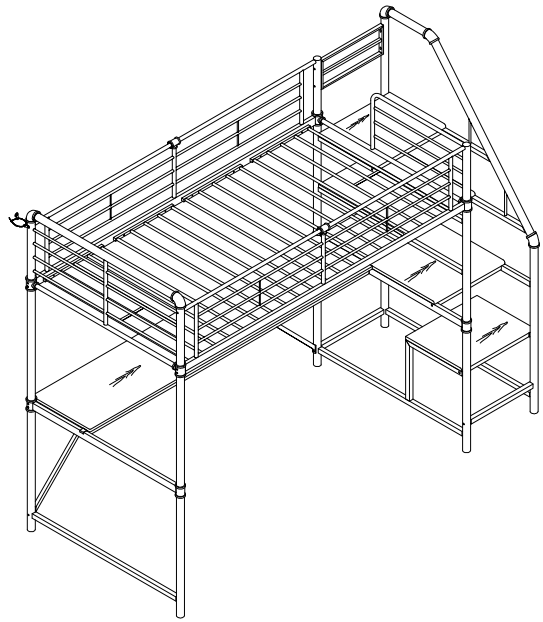
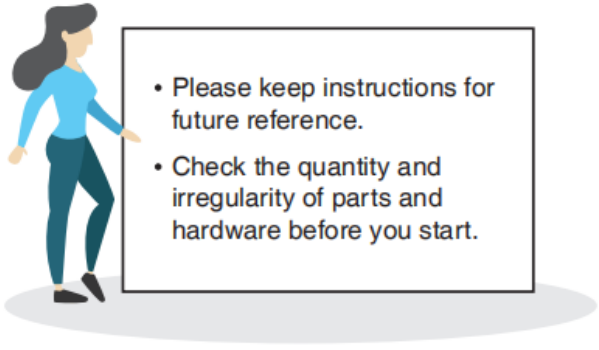

PARTS

#1 1pc

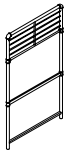

Left HB

#2 1pc



Middle HB

#3 1pc



Right HB

#4 2pcs

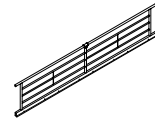

Guardrail

#5 2pcs

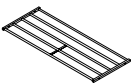

Side Bedboard

#6 2pcs



Middle Bedboard

#7 1pc

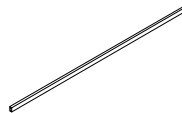

Back Tube

#8 2pcs



Connection Tube

#9 1pc



Frame

#10 3pcs



Tube 10#

#11 1pc



Tube 11#

#12 2pcs



Bottom Tube

#13 1pc

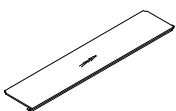

Desktop

#14 2pcs



Steps 14#

#15 1pc



Steps 15#

#16 1pc

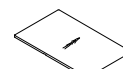

Steps 16#

Metal Twin size workstation loft bunkbed

CM-BK657



• Please keep instructions for future reference.
 • Check the quantity and irregularity of parts and hardware before you start.

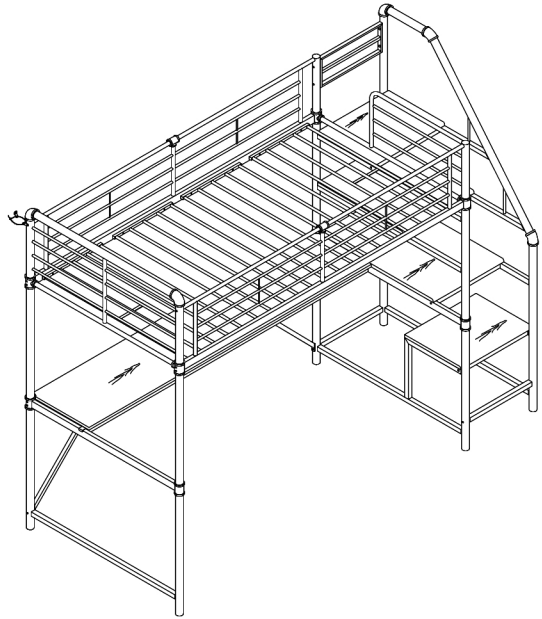

HARDWARE

#A 5pcs



Bolt 1/4" x 5/8"

#B 17pcs



Bolt 1/4" x 1"

#C 16pcs



Bolt 1/4" x 1-3/8"

#D 2pcs



Bolt 1/4" x 1-5/8"

#E 10pcs



Bolt 1/4" x 2"

#F 4pcs



Bolt 1/4" x 2-3/8"

#G 4pcs



Bolt 1/4" x 3"

#H 12pcs



Bolt 1/4" x 3"

#I 5pcs



Nut M6x27

#J 2pcs



Allen Wrench M4

#K 1pc



Screw M4

#L 2pcs



Metal Plate

#M 1pc













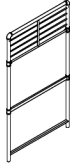











Anchor

#N 1pc



Girding

CM-BK657 Points 2 cartons

Carton	Designation	Part	Hardware
CM-BK657-1	Left HB	#1 	 #A x 5pcs  #B x 17pcs  #C x 16pcs
	Middle HB	#2 	 #D x 2pcs  #E x 10pcs
	Right HB	#3 	 #F x 4pcs  #G x 4pcs  #H x 12pcs
	Connection Tube	#8  x2	 #I x 5pcs  #J x 2pcs
	Frame	#9 	 #K x 1pc  #L x 2pcs  #M x 1pc
	Tube 10#	#10  x3	 #N x 1pc
	Tube 11#	#11 	
	Bottom Tube	#12  x2	
	Steps 14#	#14  x2	

CM-BK657 Points 2 cartons

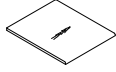
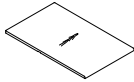
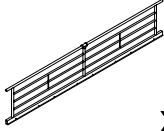
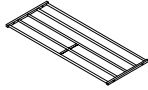
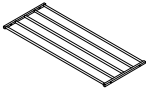
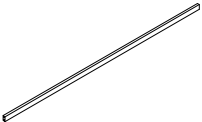
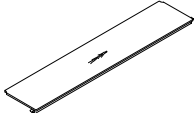
Carton	Designation		Part	Hardware
<p style="text-align: center;">CM-BK657-1</p>	Steps 15#	#15		
	Steps 16#	#16		
<p style="text-align: center;">CM-BK657-2</p>	Guardrail	#4	 <p style="text-align: right;">x2</p>	
	Side Bedboard	#5	 <p style="text-align: right;">x2</p>	
	Middle Bedboard	#6	 <p style="text-align: right;">x2</p>	
	Back Tube	#7		
	Desktop	#13		

ASSEMBLY INSTRUCTIONS

1

Exploded View

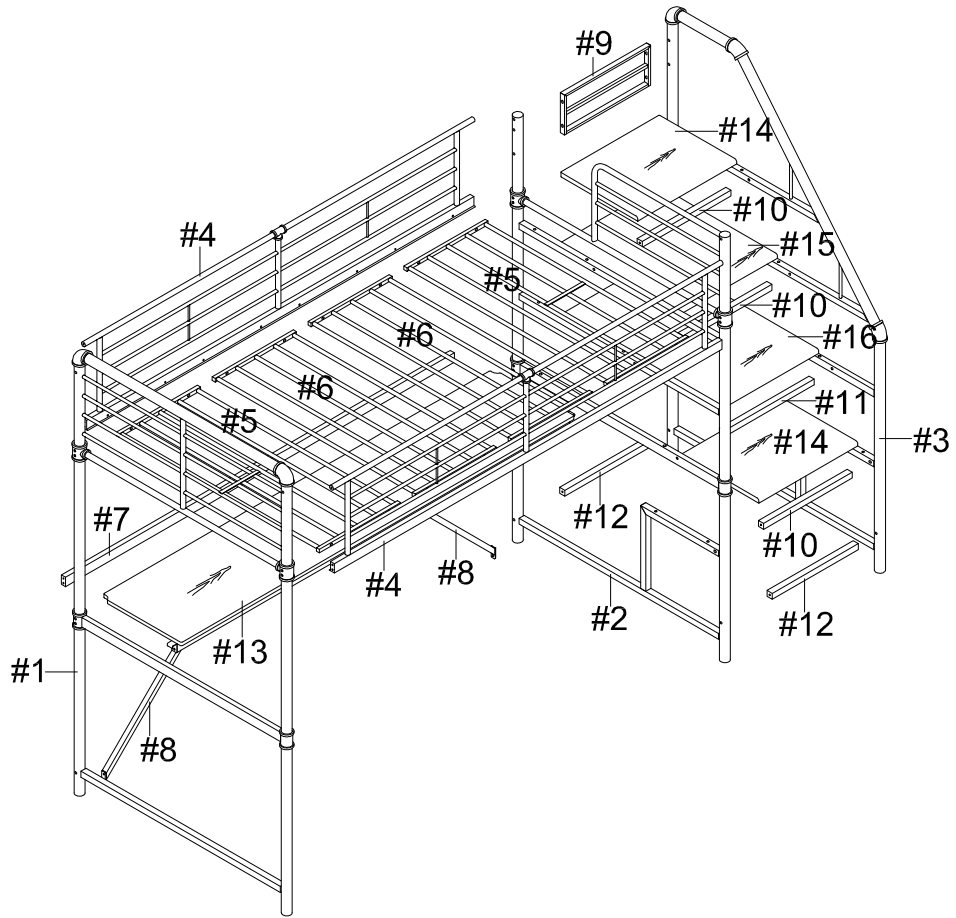

2

- Part #1 x 1pc
- Part #2 x 1pc
- Part #4 x 2pcs
- Part #7 x 1pc
- Hardware #G x 4pcs
- Hardware #H x 12pcs
- Hardware #J x 1pc
- Hardware #L x 1pc

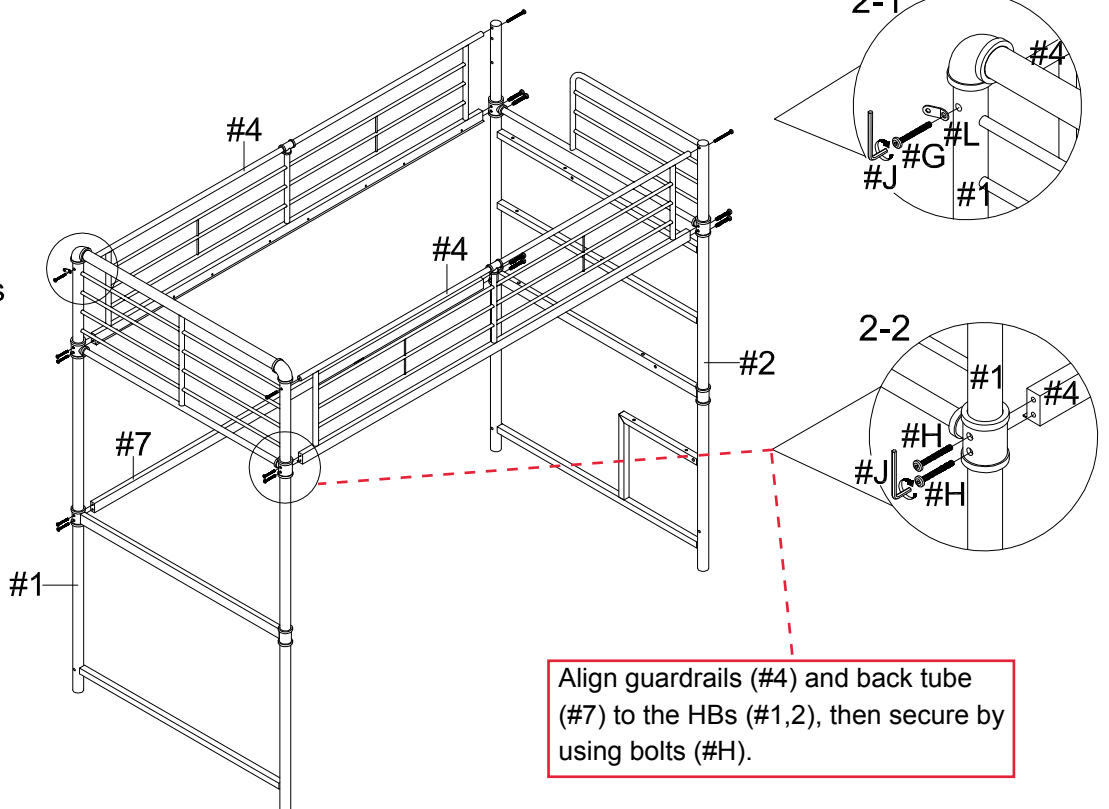

Align guardrails (#4) and back tube (#7) to the HBs (#1,2), then secure by using bolts (#H).

ASSEMBLY INSTRUCTIONS

3

- Part #5 x 2pcs
- Part #6 x 2pcs
- Hardware #B x 16pcs
- Hardware #J x 1pc

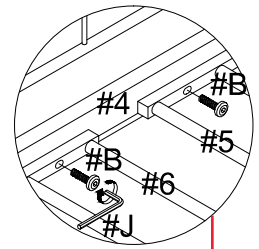
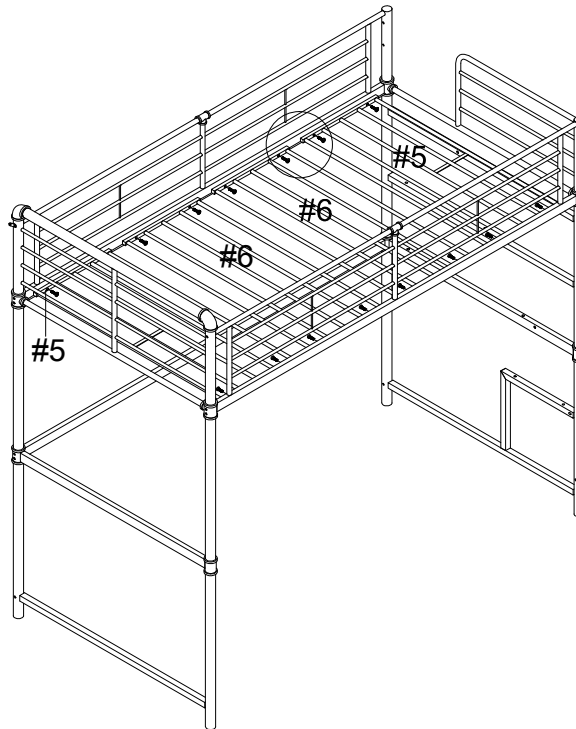

Align bedboards (#5,6) to the bunk bed, then secure by using bolts (#B).

4

- Part #3 x 1pc
- Part #8 x 1pc
- Part #10 x 3pcs
- Part #11 x 1pc
- Part #12 x 2pcs
- Hardware #A x 1pc
- Hardware #E x 8pcs
- Hardware #F x 4pcs
- Hardware #J x 1pc

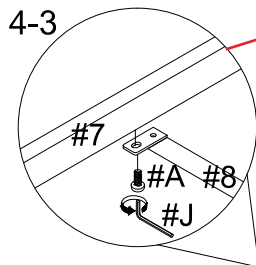

3) Align connection tube (#8) to the back tube (#7), then secure by using bolts (#A).

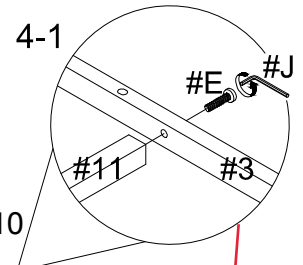
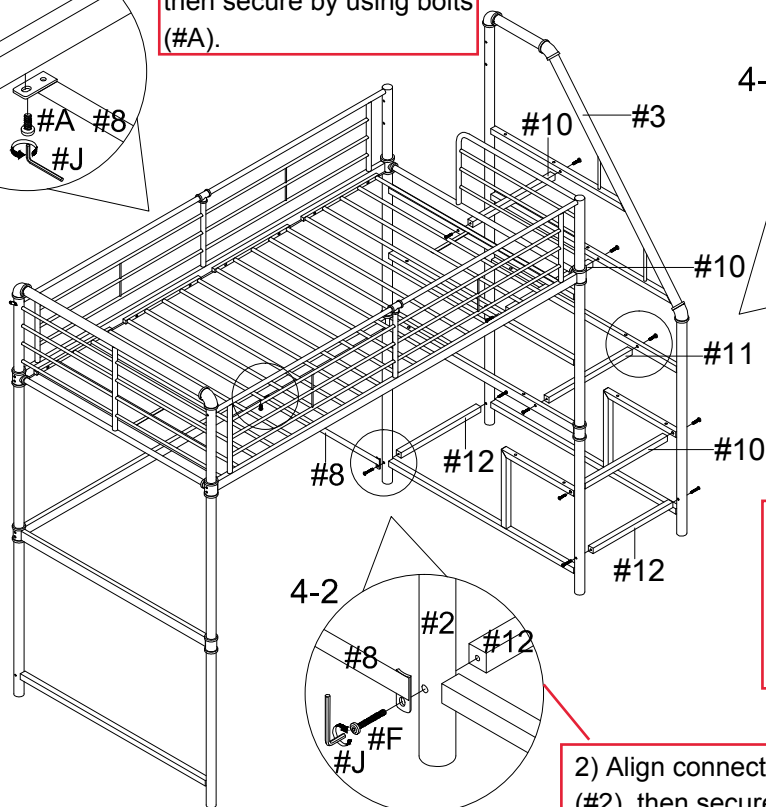

1) Align tubes (#10,11,12) to the HB (#2) and HB (#3), then secure by using bolts (#E).

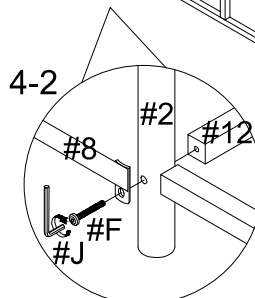

2) Align connection tube (#8) to the HB (#2), then secure by using bolts (#F).

ASSEMBLY INSTRUCTIONS

5

- Part #8 x 1pc
- Part #9 x 1pc
- Hardware #A x 1pc
- Hardware #B x 1pc
- Hardware #C x 4pcs
- Hardware #I x 5pcs
- Hardware #J x 2pcs

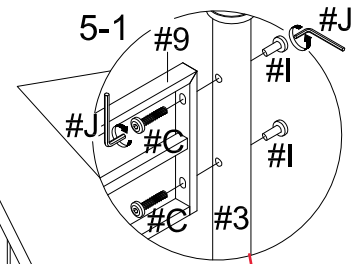
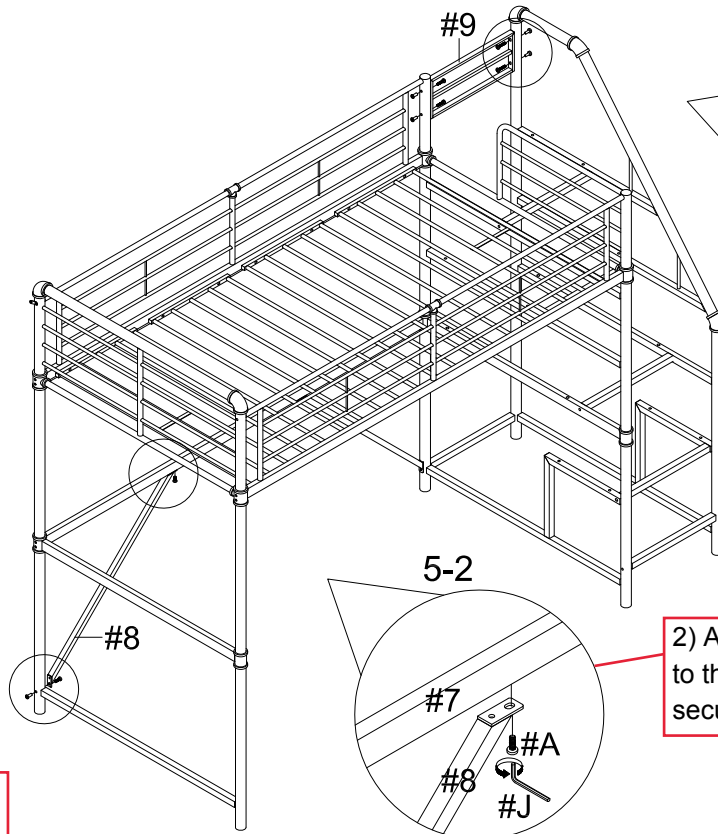

1) Align frame (#9) to the HBs (#2,3), then secure by using bolts (#C) onto nuts (#I).

5-3

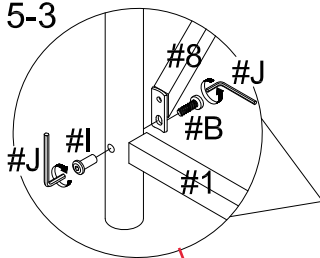

3) Align connection tube (#8) to the HB (#1), then secure by using bolts (#B) onto nut (#I).

5-2

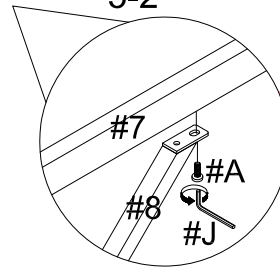

2) Align connection tub (#8) to the back tube (#7), then secure by using bolts (#A).

6

- Part #13 x 1pc
- Hardware #A x 3pcs
- Hardware #J x 1pc

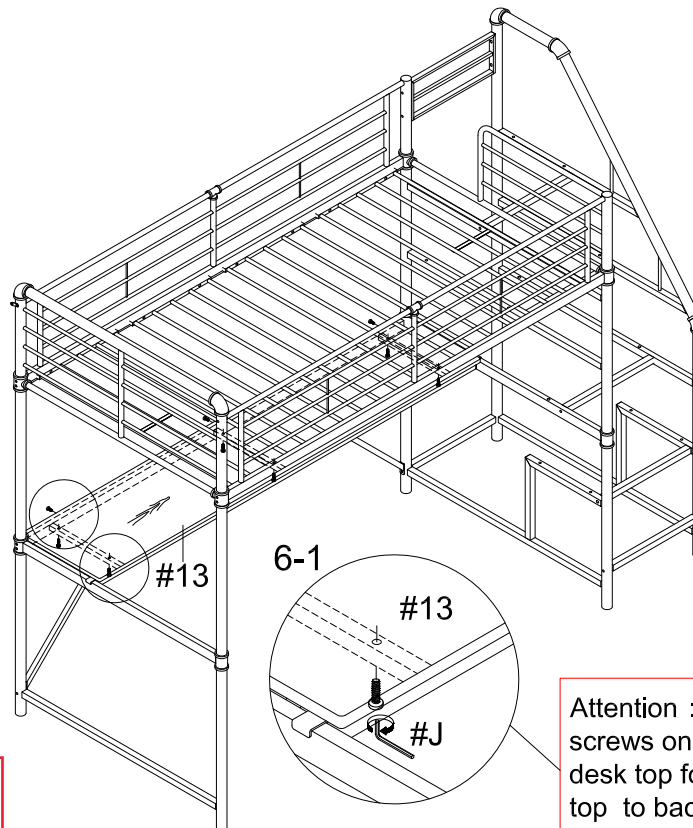

6-2

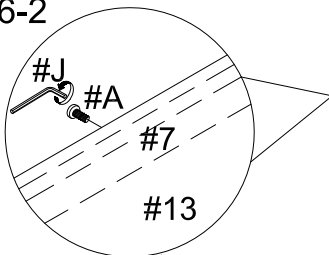

Align desk top (#13) to back tube (#7), then secure by using bolts (#A).

6-1

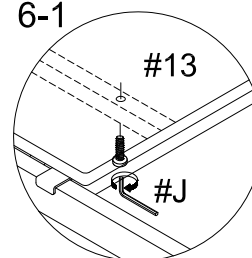

Attention : Loosen the assembled screws on the underneath of the desk top for easy assembly the desk top to back tube, then tighten after full assembly.

ASSEMBLY INSTRUCTIONS

7

- Part #14 x 2pcs
- Part #15 x 1pc
- Part #16 x 1pc
- Hardware #C x 12pcs
- Hardware #D x 2pcs
- Hardware #E x 2pcs
- Hardware #J x 1pc

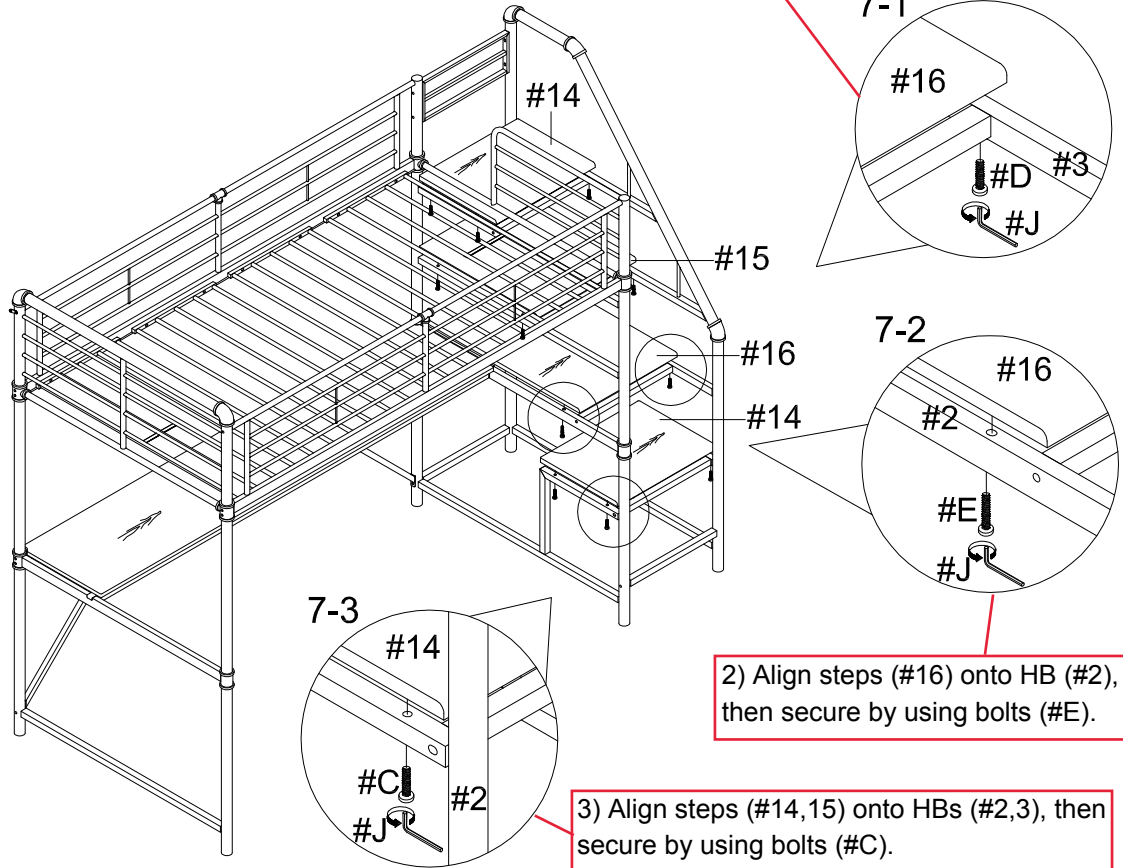

8

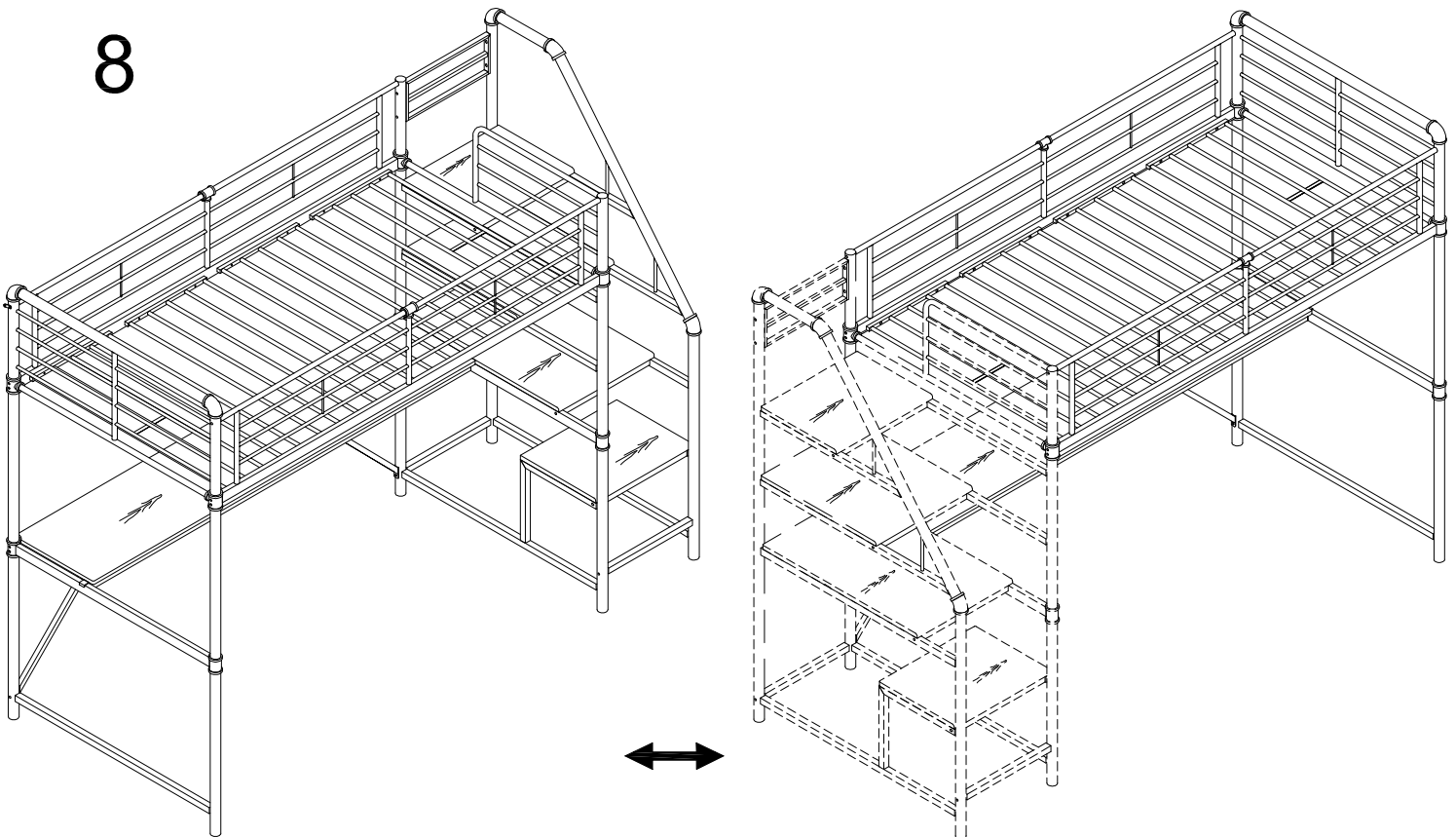

NOTE: STAIRS CAN BE INSTALLED ON EITHER SIDE

ASSEMBLY INSTRUCTIONS

9

- Hardware #K x 1pc
- Hardware #L x 1pc
- Hardware #M x 1pc

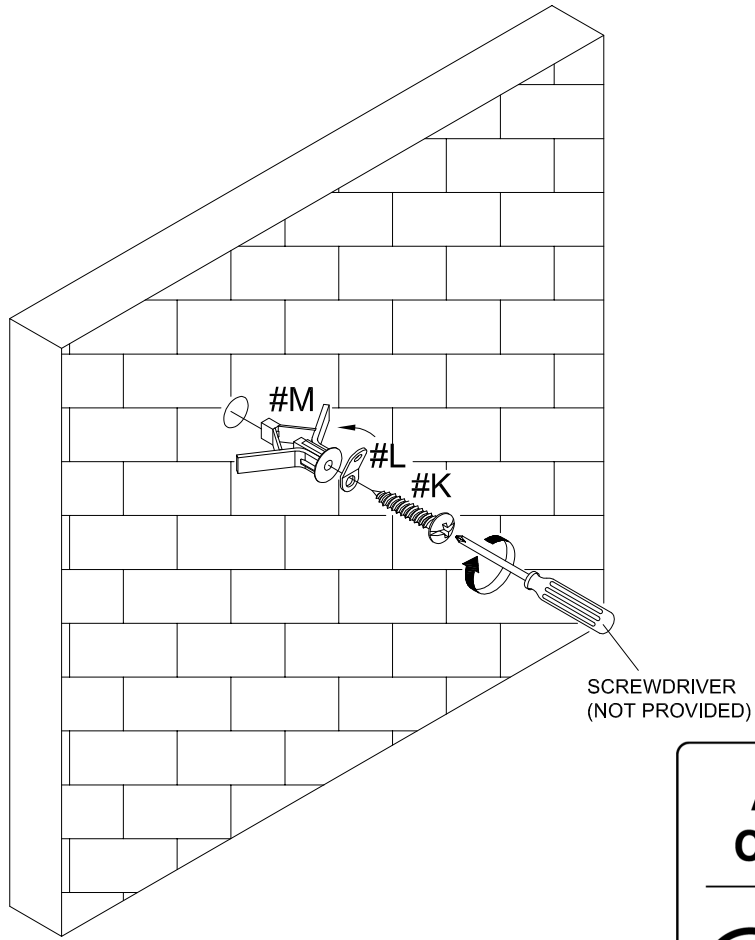

ASSEMBLY COMPLETED



Please ensure the furniture rests on an even and flat surface. If the product wobbles or feels loose, double-check all bolts and/or screws are properly tightened and secured.

10

- Hardware #N x 1pc

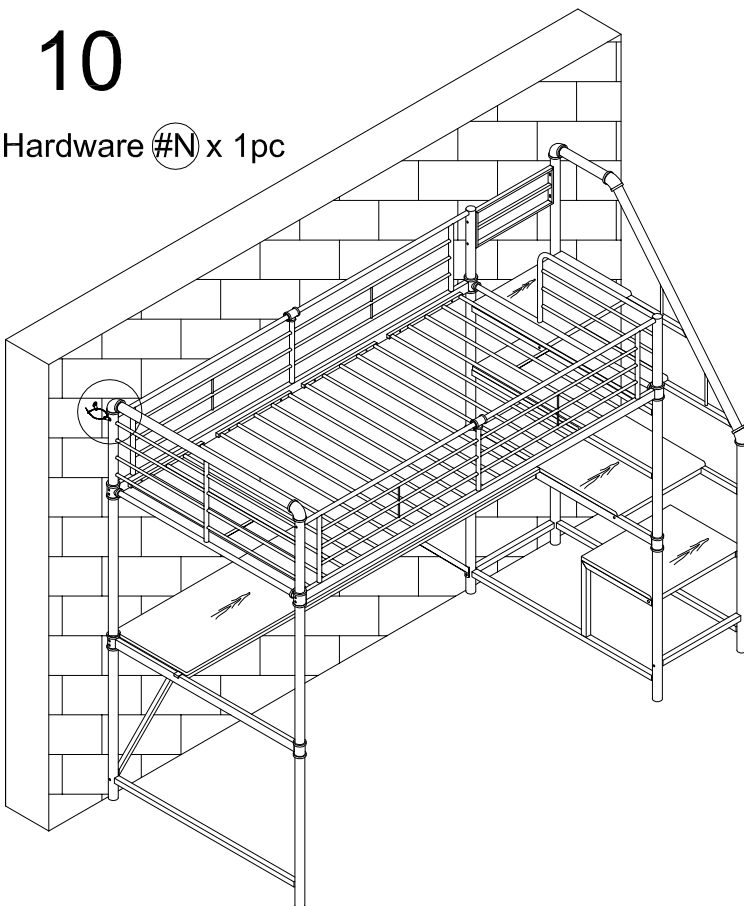

To Prevent Tip over
Product Must Be
Attached To Wall

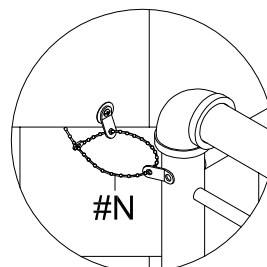

✓ Keep this handy!

Please retain this instruction manual and any order-related information for future reference.

✓ Lift, don't drag!

To avoid damage to product please always LIFT the product when transporting or adjusting the placement.

ASSEMBLY INSTRUCTIONS

Wall Mounting and Fixing



EXPANSION WALL ANCHOR

Our provided expansion wall anchors are only suitable for masonry walls, such as drywall, plaster or concrete, and are best for holding lightweight items or for anti-tip prevention. If you are unsure of the correct wall anchor to use with the product, please request professional guidance. Liability for product damage or failure due to using the incorrect anchors will fall on the installer.

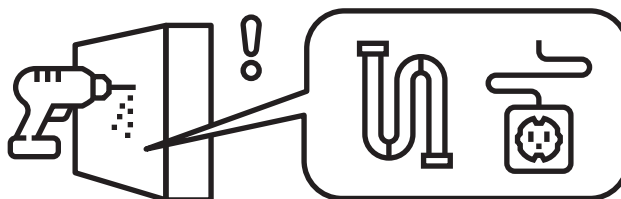

CHECK BEFORE PROCEEDING

Prior to drilling or hammering, please check for wires or pipes. We recommend using a stud finder to locate a stud, which will offer more appropriate resistance and hold more weight.

QUICK TIPS

1. If unsure of the proper size, always choose a larger screw and wall anchor.

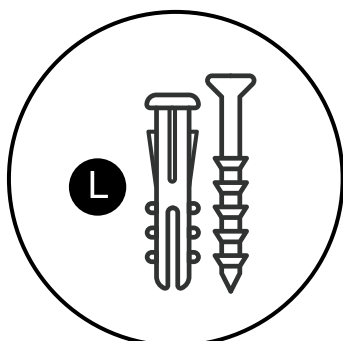

2. Match the drill bit to the wall anchor and hole size.

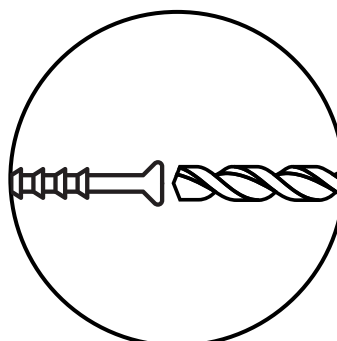

3. Only drill horizontally. Do not force the drill or enlarge the hole for the wall anchor.

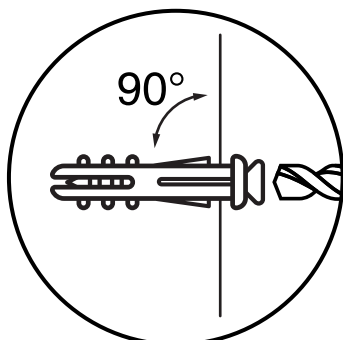

4. Take extra care when drilling into high walls or ceramic tiles. Wall anchors should be a tight fit for the hole. Never use wall anchors in ceilings.

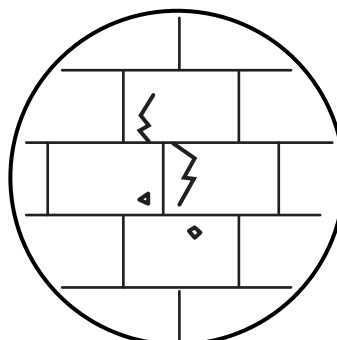

MAINTENANCE



We recommend a yearly check to see if the wall anchor or screw has loosened. If so, please remove the existing wall anchor and screw, and use a new anchor.

Safety Warnings

1. Follow the information on the warnings appearing on the upper bunk end structure and on the carton . Do not remove warning label from bed.
2. Always use the recommended size mattress or/and mattress support to help prevent the likelihood of entrapment or falls.
3. Surface of mattress must be at least 5 in. below the upper edge of guardrails .
4. Do not allow children less than 6 years of age to use the upper bunk.
5. Periodically check and ensure that the guardrail, ladder ,and other components are in their proper position ,free from damage ,and that all connectors are tight .
6. Prohibit horseplay on/or under the bed and prohibit jumping on the bed.
7. Always use the ladder for entering and leaving the upper bunk.
8. Do not use substitute parts ,Contact manufacturer or dealer for replacement parts.
9. Use of a night light may provide added safety precaution for a child using the upper bunk.
10. Always use guardrails on both long sides of the upper bunk.
11. If the bunk bed will be placed next to a wall, the guardrail that runs the full length of the bed should be placed against the wall to prevent entrapment between the bed and the wall.
12. The use of water or sleep flotation mattress is prohibited .
13. Keep these instructions for future reference.
14. Use only mattress which is 74 3/4"x39" x6" on upper bunk.
15. Prohibit more than one person on upper bunk.

STRANGULATION HAZARD:

16. Never attach or hang items to any part of the bunk bed that are not designed for use with the bed for example, but not limited to hooks, belts, and jump ropes.