

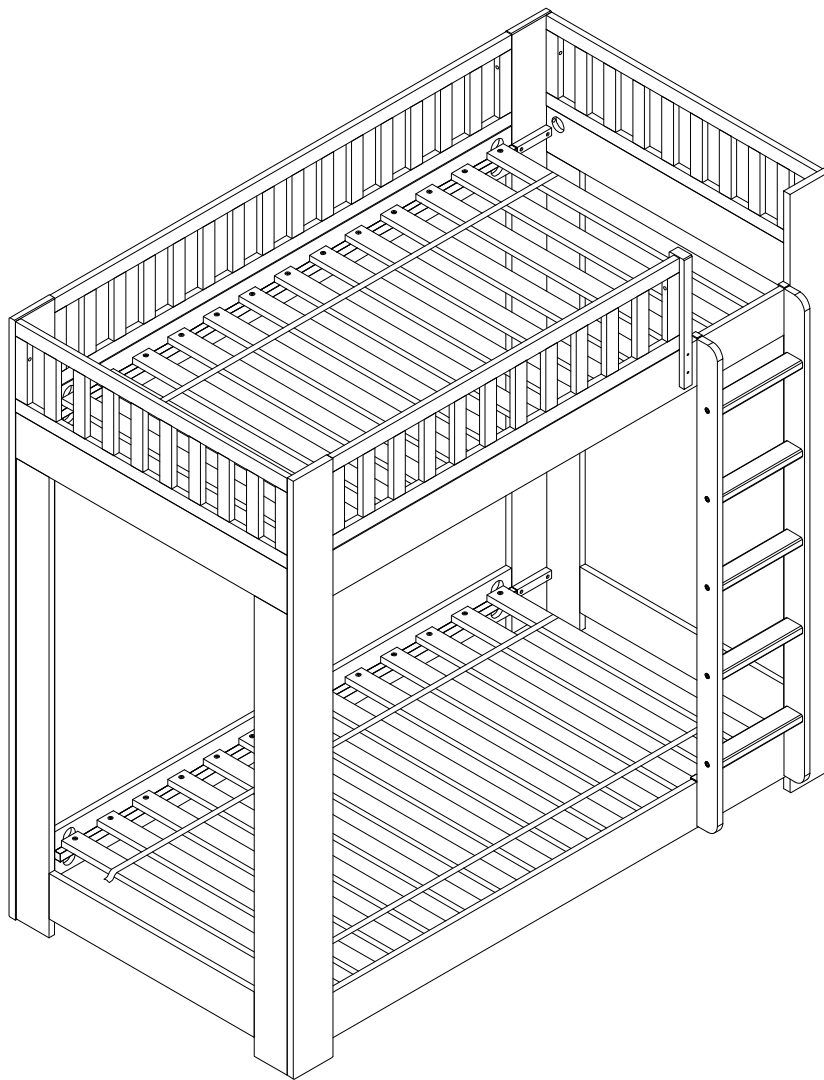











*** Thank you for purchasing this quality product. Be sure to check all packing materials carefully for small parts which may have come loose inside the carton during shipment. Identify and count all parts and compare with parts list below.

*** Assemble product on a flat, soft surface such as a carpet or cloth to prevent scratching the finish. Read all instruction and study the drawings carefully before starting the assembly process.











IMPORTANT: Do not tighten bolts completely until all bolts are completely lined up and inserted into holes

PARTS LIST

NO.	DIAGRAM	PART NAME	Q'Ty
1		Upper Connect Headboard	2 pcs
2		Post of the Bed (Left)	2 pcs
3		Post of the Bed (Right)	2 pcs
4		Upper Front Side Rail	1 pc
5		Upper Back Side Rail	1 pc
6		Lower Side Rail	2 pcs
7		Lower Connect Headboard	2 pcs
8		Ladder Rail (Right Side)	1 pc
9		Ladder Rail (Left Side)	1 pc
10		Ladder Step	5 pcs
11		Guardrail Support	1 pc
12		Twin Slats Kit (14pcs/1set)	2 Set

HARDWARE LIST







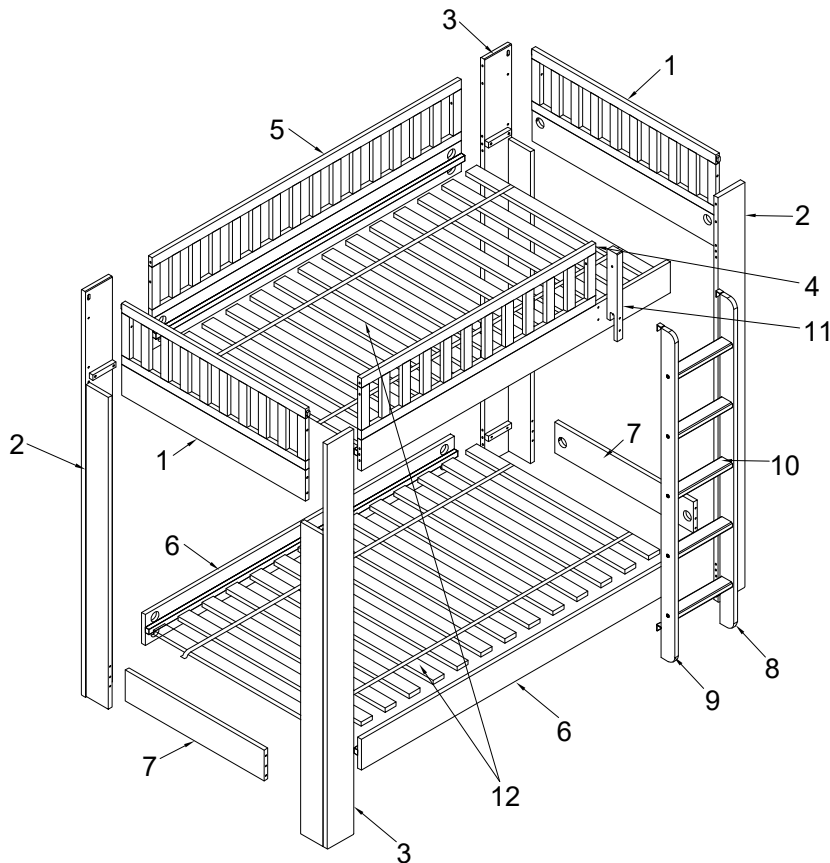



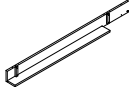







NO.	DIAGRAM	PART NAME	Q'Ty
A		Threaded Pin 7.8 x 80mm Half Round Nut / Hex Nut	16 sets
B		Threaded Pin 7.8 x 60mm Half Round Nut / Hex Nut	8 sets
C		Bolt 6.3 x 55 (mm)	10 pcs
D		Bolt 7 x 50 (mm)	10 pcs
E		Wood Dowel 10 x 40 (mm)	23 pcs
F		Screw 4 x 30 (mm)	52 pcs
G		Screw 4 x 15 (mm)	4 pcs
H		Allen Key (M4)	1 pc
I		Wrench (M11)	1 pc

TOOL REQUIRED:

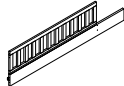
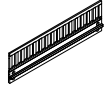
 Cross-head Screwdriver (Not provided)

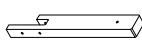
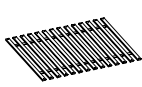

#BD00612 is packed in 2 cases

Carton	Disignation	Part	Hardware	
Item: BD00612-1	Post of the Bed (Left) x 2pcs	#2 		
	Post of the Bed (Right) x 2pcs	#3 		
Item: #BD00612-2	Upper Connect Headboard x 2pcs	#1 	<p>A   Threaded Pin 7.8 x 80mm Half Round Nut / Hex Nut</p> <p>B   Threaded Pin 7.8 x 60mm Half Round Nut / Hex Nut</p> <p>C  Bolt 6.3 x 55 (mm)</p> <p>D  Bolt 7 x 50 (mm)</p> <p>E  Wood Dowel 10 x 40 (mm)</p> <p>F  Screw 4 x 30 (mm)</p> <p>G  Screw 4 x 15 (mm)</p> <p>H  Allen Key (M4)</p> <p>I  Wrench (M11)</p>	
	Short Guardrail x 1pc	#4 		
	Long Guardrail x 1pc	#5 		
	Lower Side Rail x 2pcs	#6 		
	Lower Connect Headboard x 2pcs	#7 		
	Ladder Rail (Right Side) x 1pc	#8 		
	Ladder Rail (Left Side) x 1pc	#9 		
	Ladder Step x 5pcs	#10 		
	Guardrail Support x 1pc	#11 		
	Twin Slats Kit (14pcs/1set) x 2 sets	#12 		

STEP 1: UPPER / LOWER SIDE RAIL HEADBOARDS ASSEMBLY

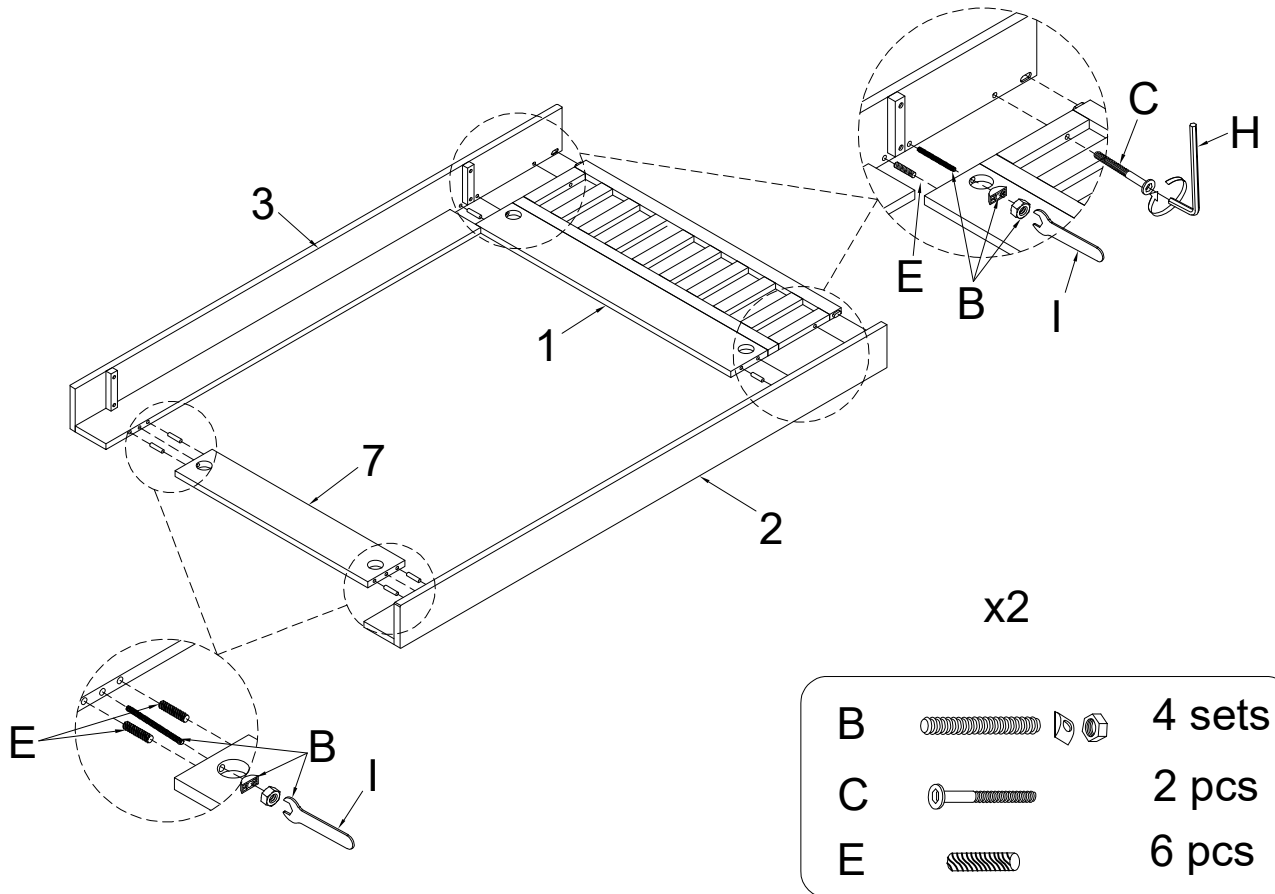

STEP 2: GUARDRAILS ASSEMBLY

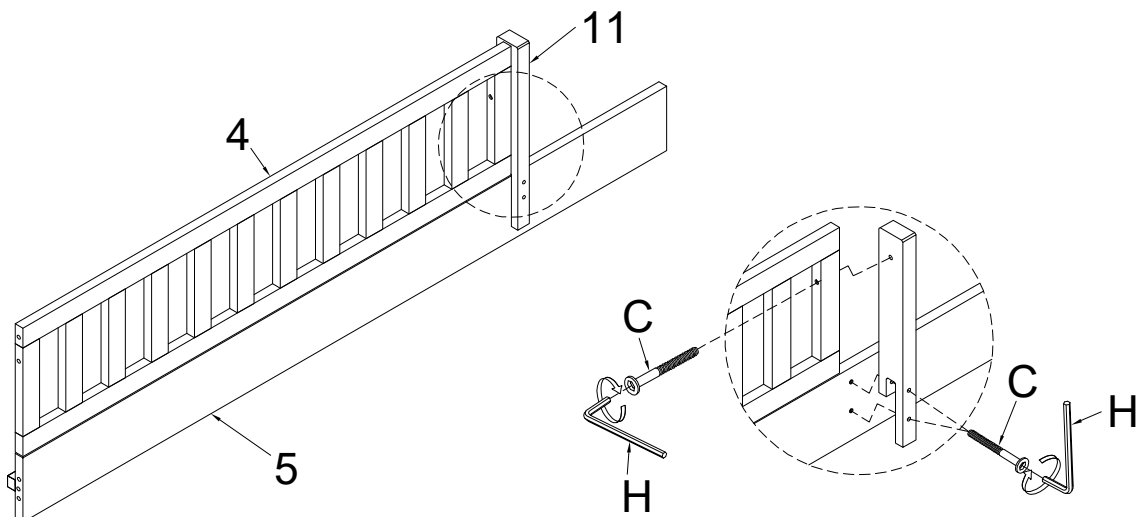

C		3 pcs
---	---	-------

STEP 3: GUARDRAIL SUPPORTS / RAIL ASSEMBLY

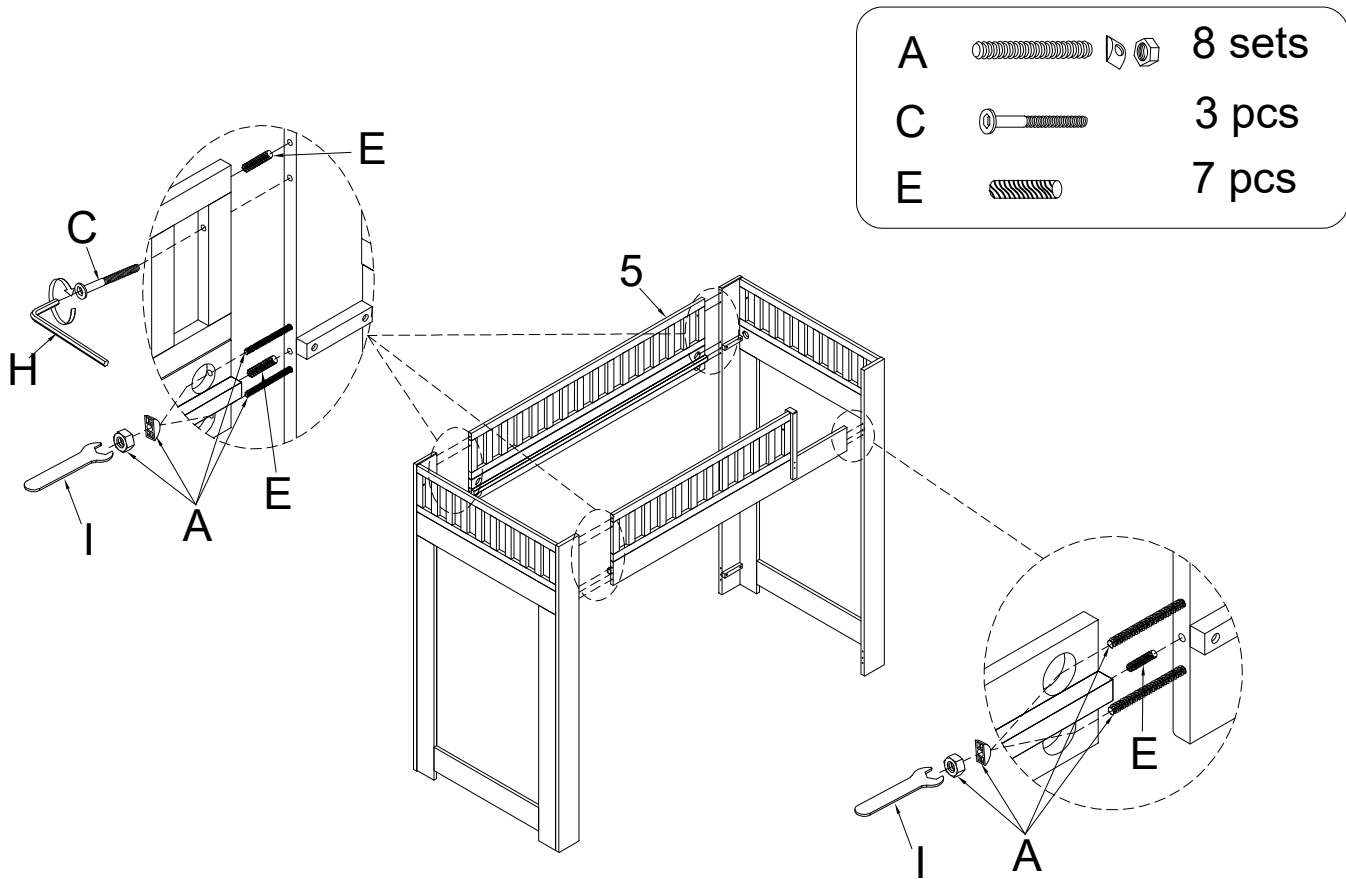

STEP 4: LOWER SIDE RAIL ASSEMBLY

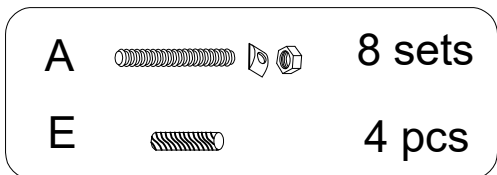
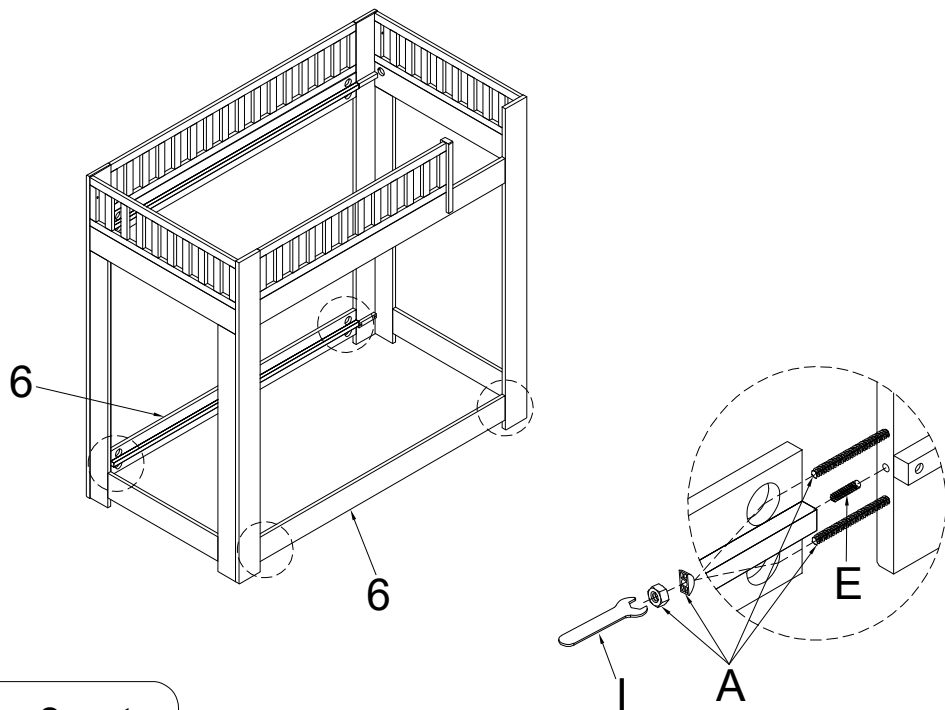

STEP 5: LADDER ASSEMBLY

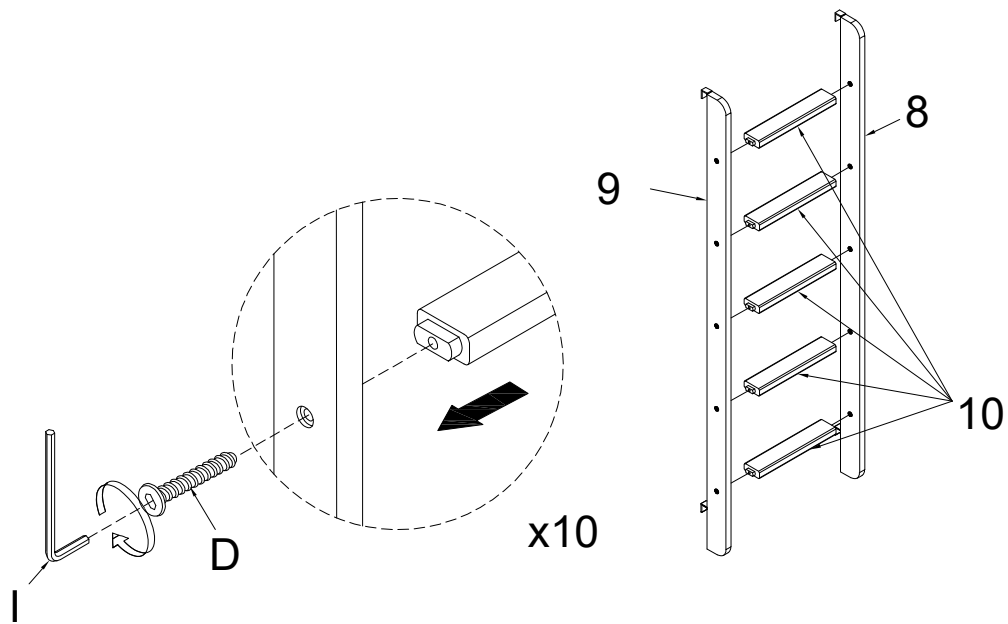

D



10 pcs

STEP 6: COMPLETED TWIN SLATS ASSEMBLY

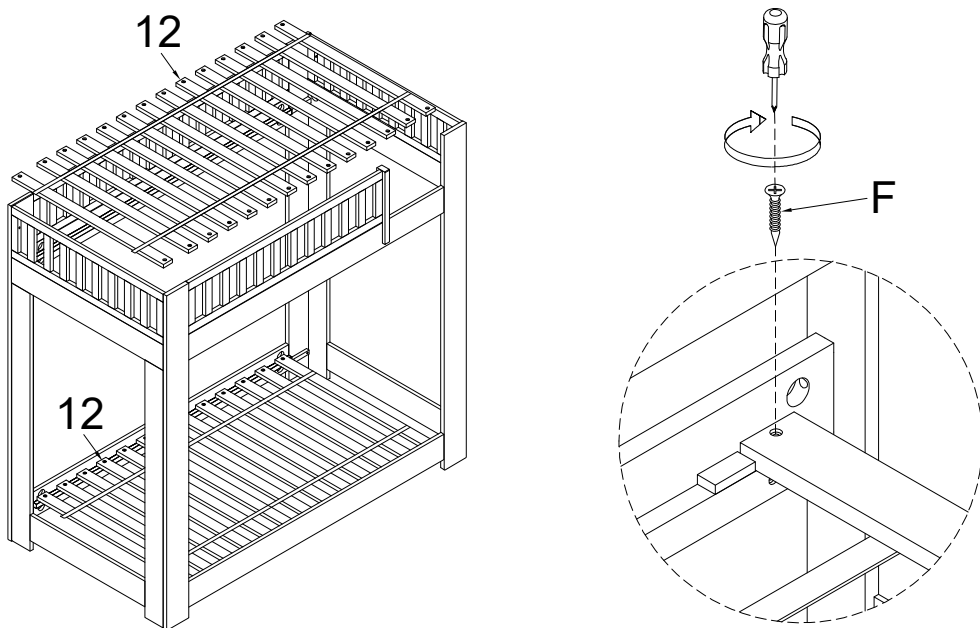

F



52 pcs

STEP 7: PUT LADDER ON BED ASSEMBLY

G



4 pcs

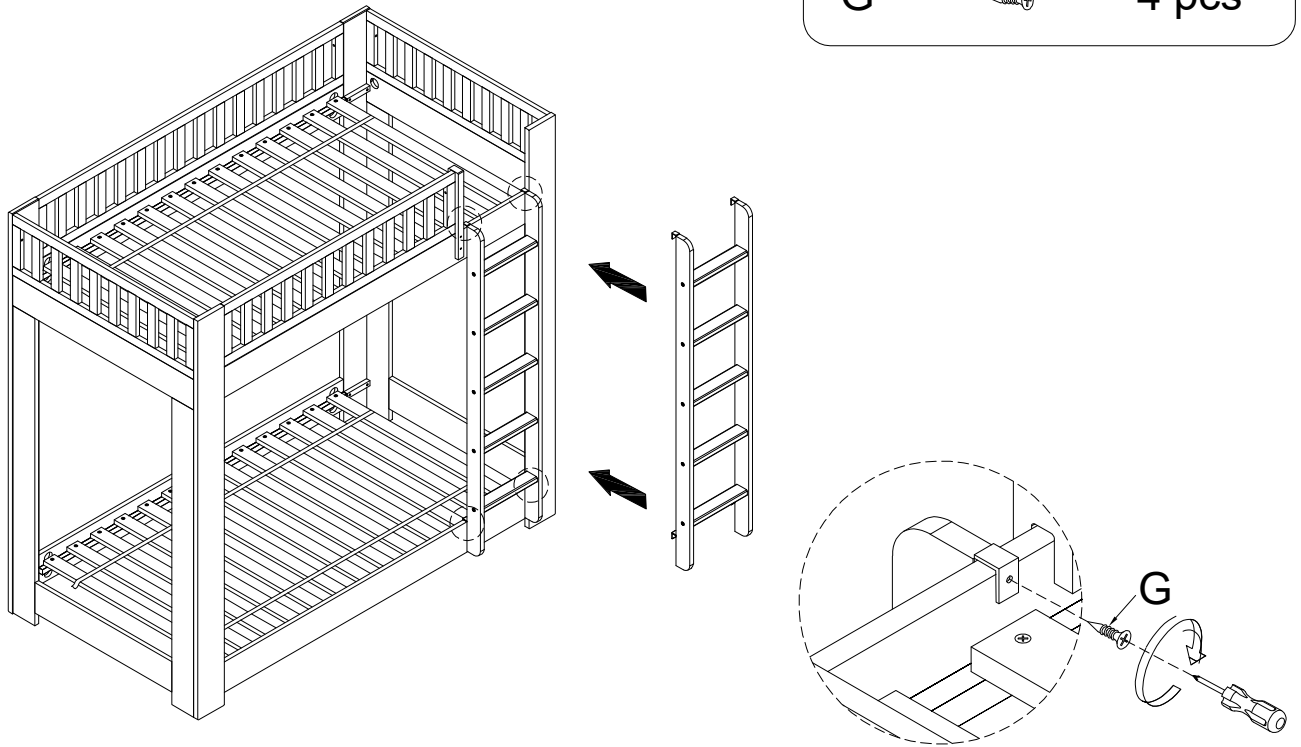

STEP 8:

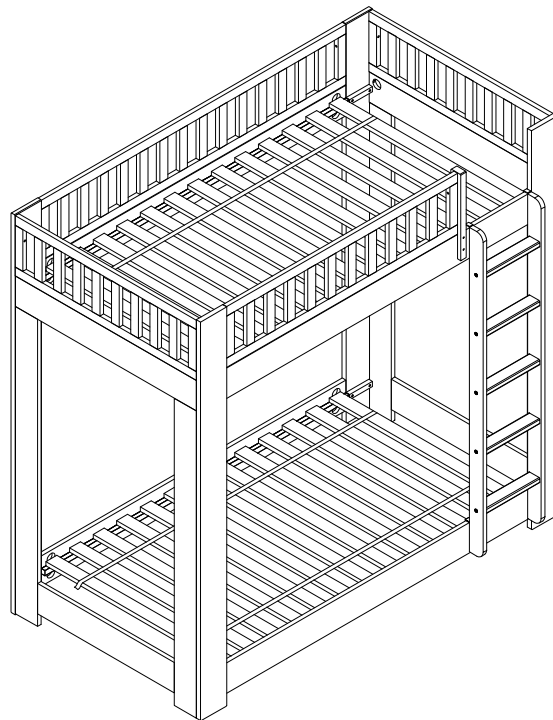

ASSEMBLY IS COMPLETED

WARNING !!!

To help prevent serious or fatal injuries from entrapment or falls:

1. Follow the information on the warning label appearing on the upper bunk end structure and on the carton. Do not remove warning label from bed.
2. Use only mattress which is 39" WIDE AND 75" LONG ON UPPER BUNK.
3. Ensure thickness of upper mattress does not exceed 6" and top surface of mattress is at least 5" below the upper edge of guardrails.
4. Do not allow children under 6 years to use the upper bunk.
5. Periodically check and ensure that the guardrail, ladder, and other components are in their proper position, free from damage, and that all connectors are tight.
6. Do not allow horseplay on or under the bed and prohibit jumping on the bed.
7. Always use ladder for entering and leaving upper bunk.
8. Do not use substitute parts. Contact the manufacturer or dealer for replacement parts.
9. Use of a night-light may provide added safety precaution for a child using the upper bunk.
10. Always use guardrails on both long sides of the upper bunk. If the bunk bed will be placed next to a-wall, the guardrail that runs the full length of the bed should be placed against the wall to prevent entrapment between the bed and the wall.
11. The use of water or sleep flotation mattresses is prohibited.

STRANGULATION HAZARD:

12. Never attach or hang items to any part of the bunk bed that are not designed for use with the bed, for example, but not limited to, hooks, belts and jump ropes.
13. Prohibit more than one person on upper bunk.
14. Maximum total weight not to exceed-150 lbs on the upper bunk, and maximum 200 lbs on lower bunk.
15. Keep these instructions for future reference.