

21cm

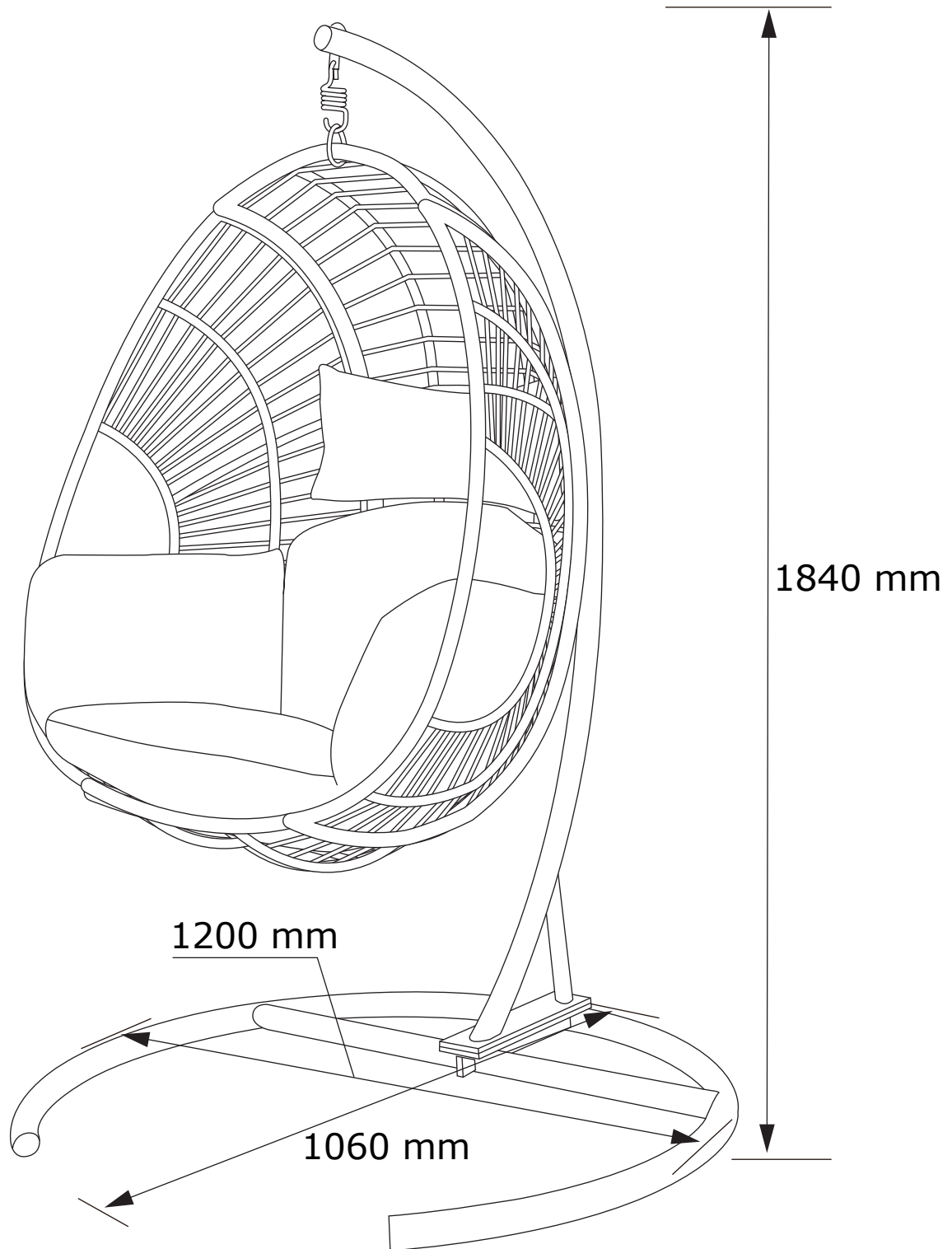

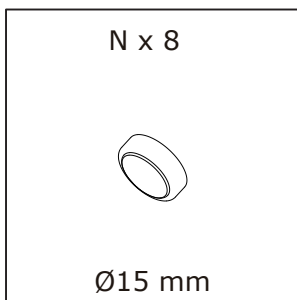

29cm

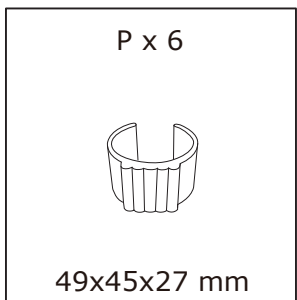
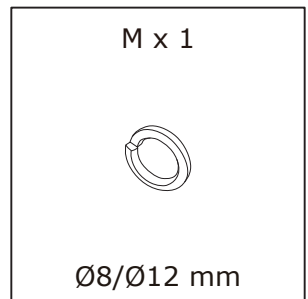
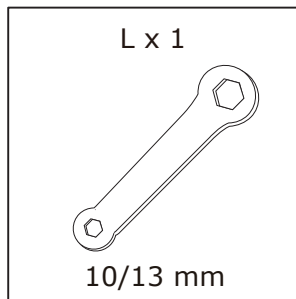
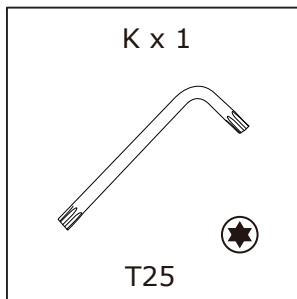
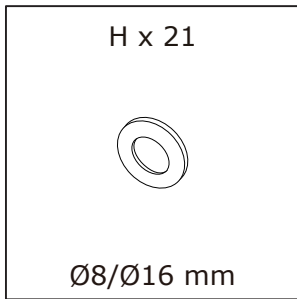
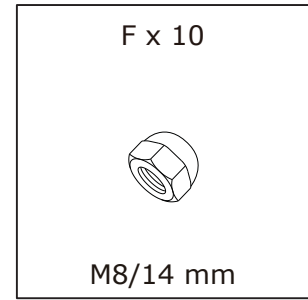
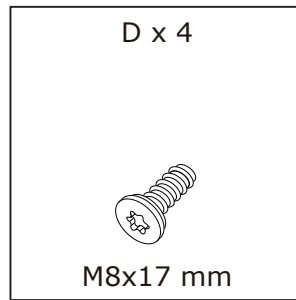
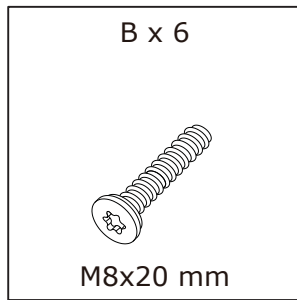
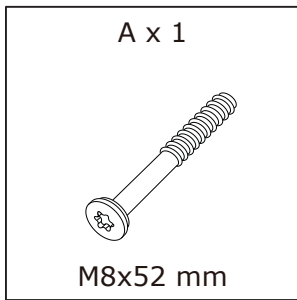
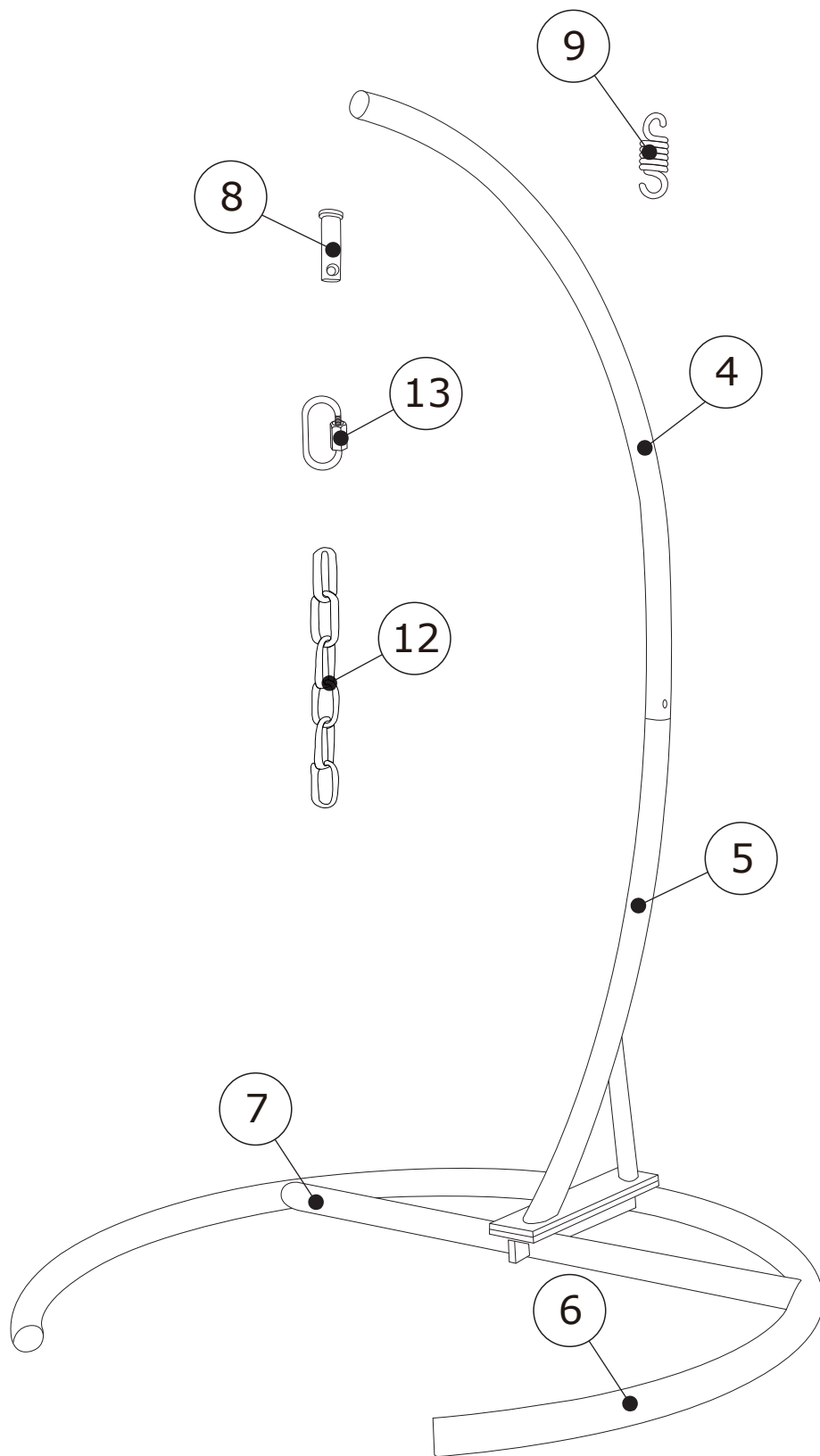









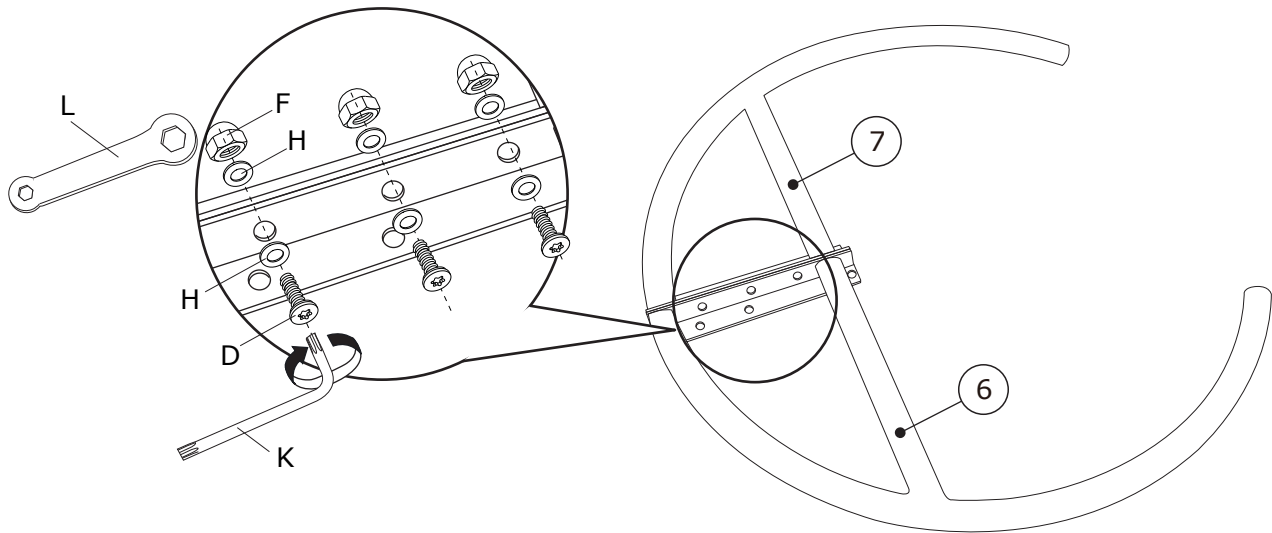
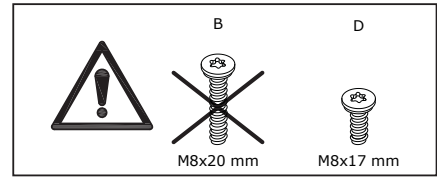

1

|  |  |   |  |  |  |
|--|--|---|--|--|--|
| D x 3<br><br>M8x17 mm | F x 3<br><br>M8/14 mm | H x 6<br><br>Ø8/Ø16 mm | K x 1<br><br>T25 | L x 1<br><br>10/13 mm |  |
|--|--|---|--|--|--|







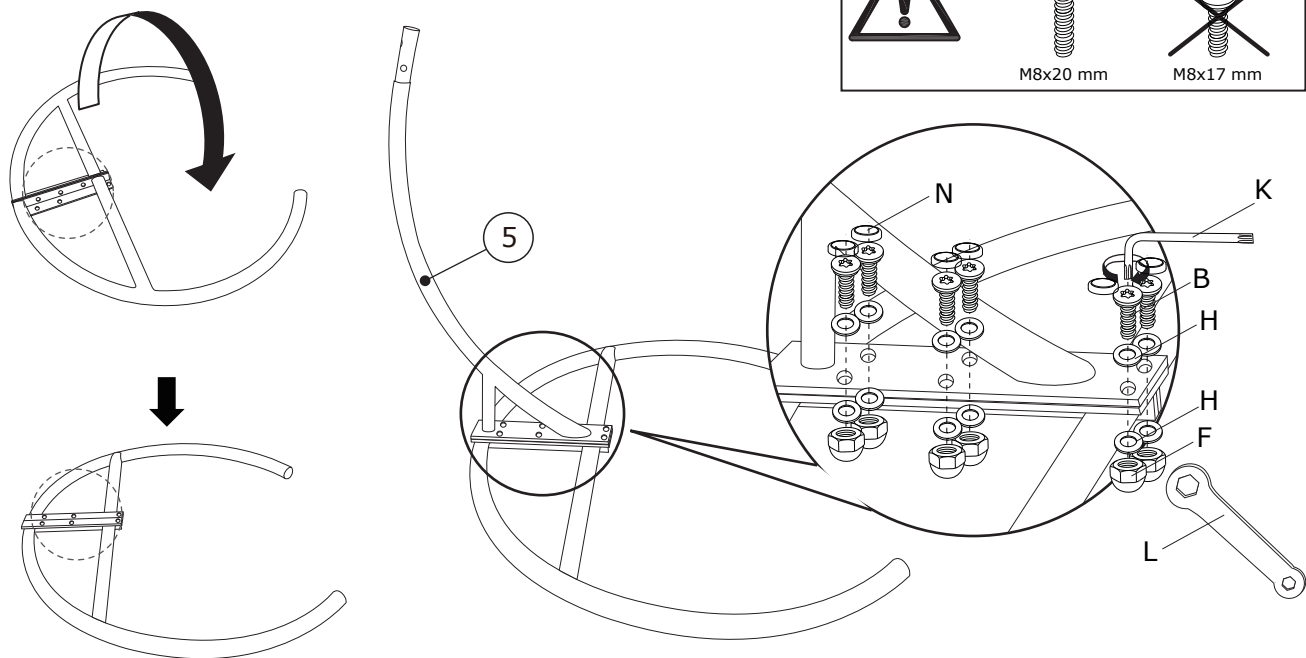
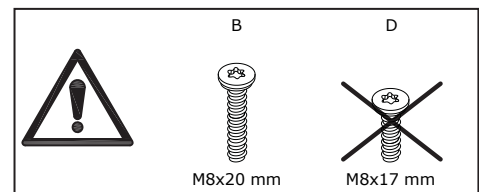

2

|  |  |  |  |  |  |  |
|--|--|--|--|--|--|--|
| B x 6<br><br>M8x20 mm | F x 6<br><br>M8/14 mm | H x 12<br><br>Ø8/Ø16 mm | K x 1<br><br>T25/T30 | L x 1<br><br>10/13 mm | N x 6<br><br>Ø15 mm |  |
|--|--|--|--|--|--|--|





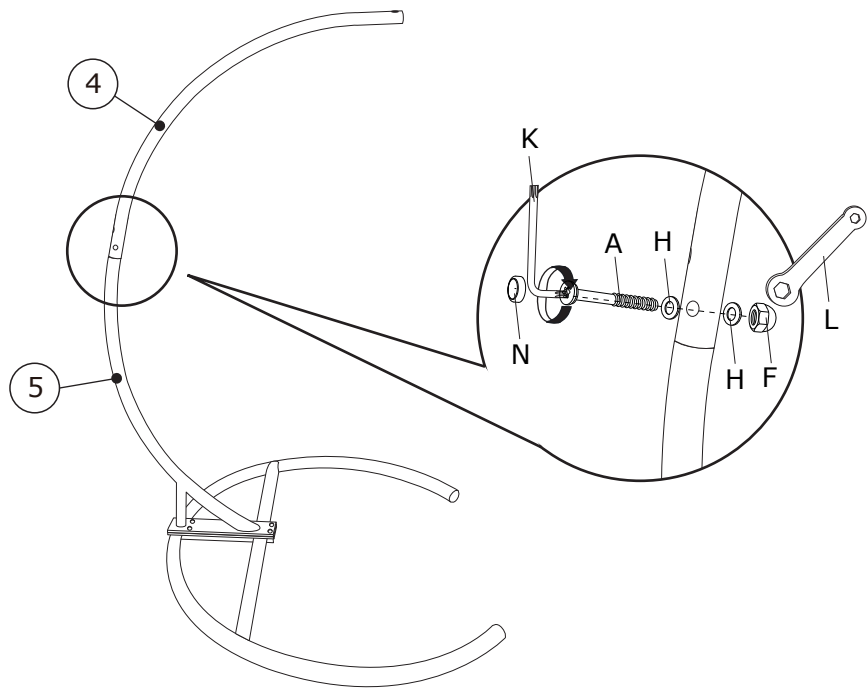

3

|  |  |   |  |  |  |  |
|--|--|---|--|--|--|--|
| A x 1<br><br>M8x52 mm | F x 1<br><br>M8/14 mm | H x 2<br><br>Ø8/Ø16 mm | K x 1<br><br>T25 | L x 1<br><br>10/13 mm | N x 1<br><br>Ø15 mm |  |
|--|--|---|--|--|--|--|



4

|   |   |   |  |   |  |
|---|---|---|--|---|--|
| Dx 1<br><br>M8x17 mm | M x 1<br><br>Ø8/Ø12 mm | K x 1<br><br>T25 | N x 1<br><br>Ø15 mm | H x 1<br><br>Ø8/Ø16 mm |  |
|---|---|---|--|---|--|

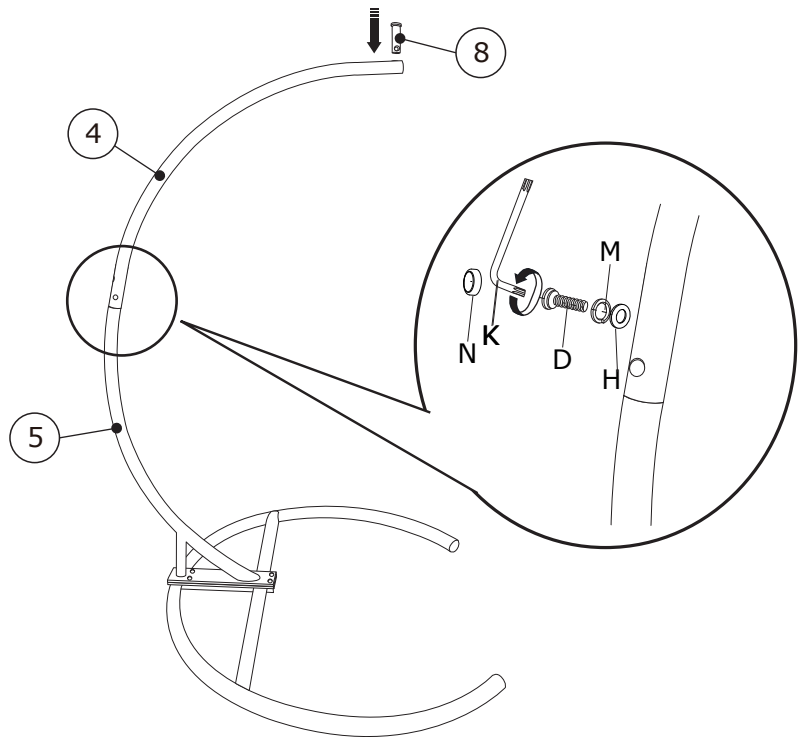

5

