







ASSEMBLY INSTRUCTION

DDP-2291L

- (A)  3.5x40=28+1x
- (B)  3.5x35=4+1x
- (C)  3.5x25=2+1x
- (D)  3.0x16=24+1x
- (E)  =4x
- (F)  =2x

PARTS

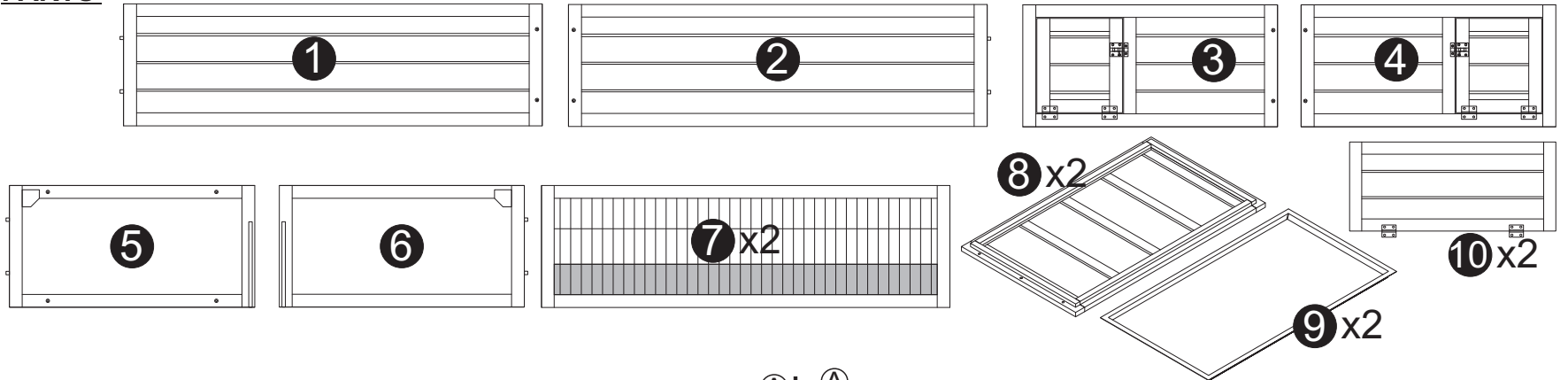

ASSEMBLY

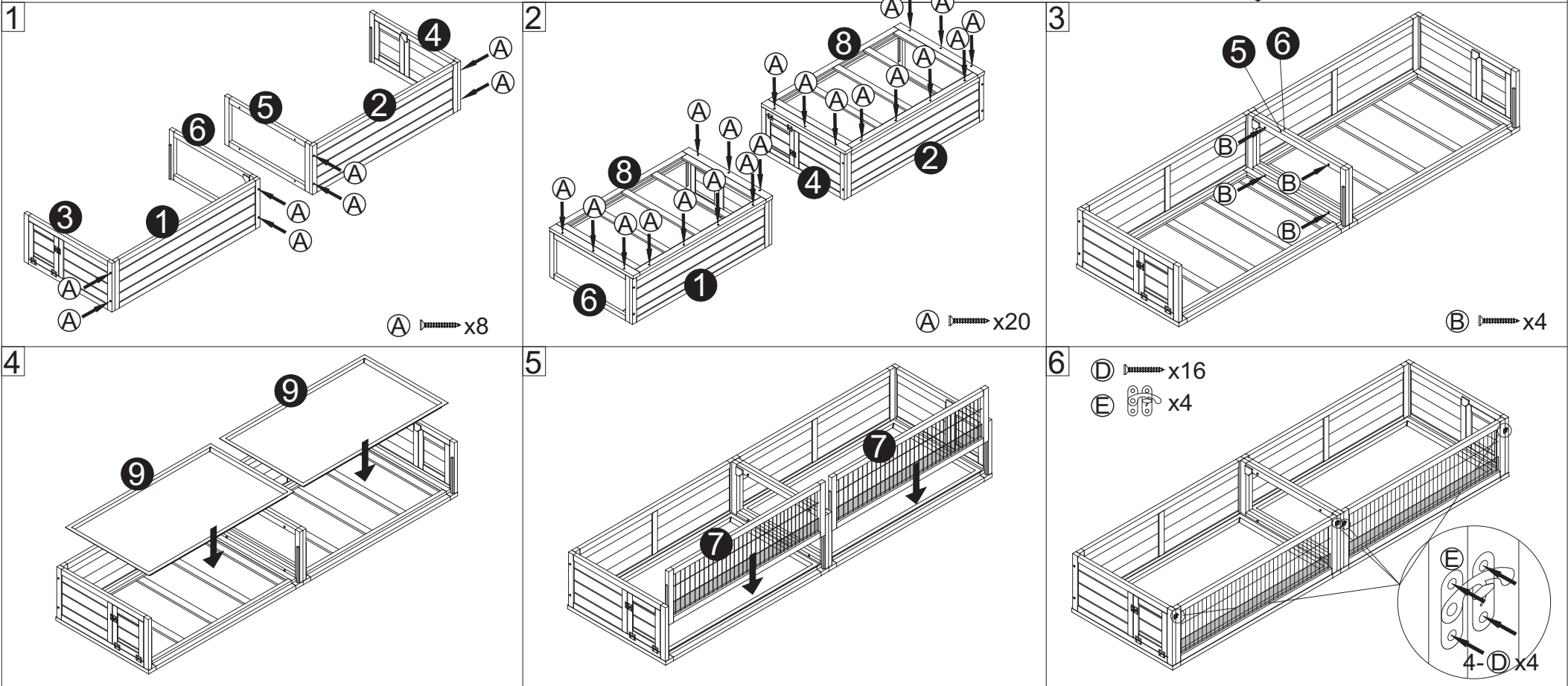

ASSEMBLY:TWO SPLIT CAGES

STEP1

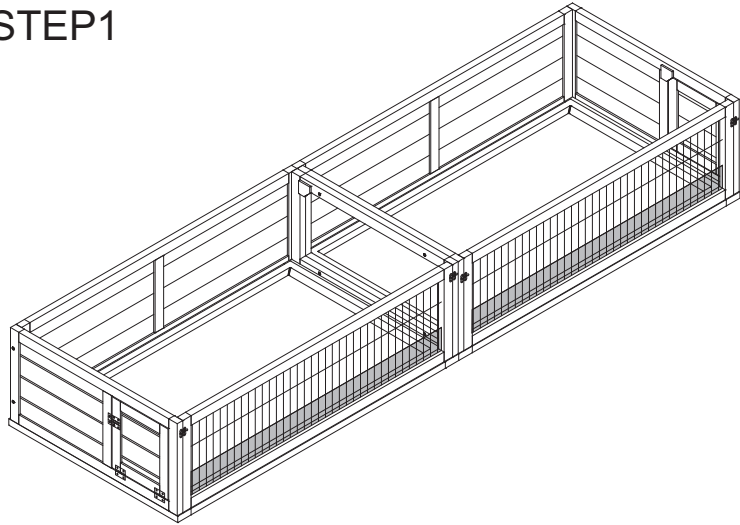

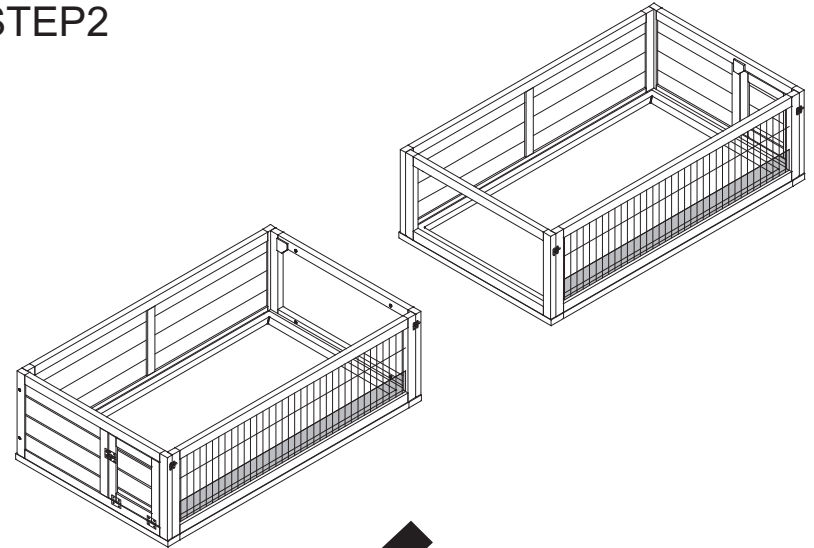

STEP2

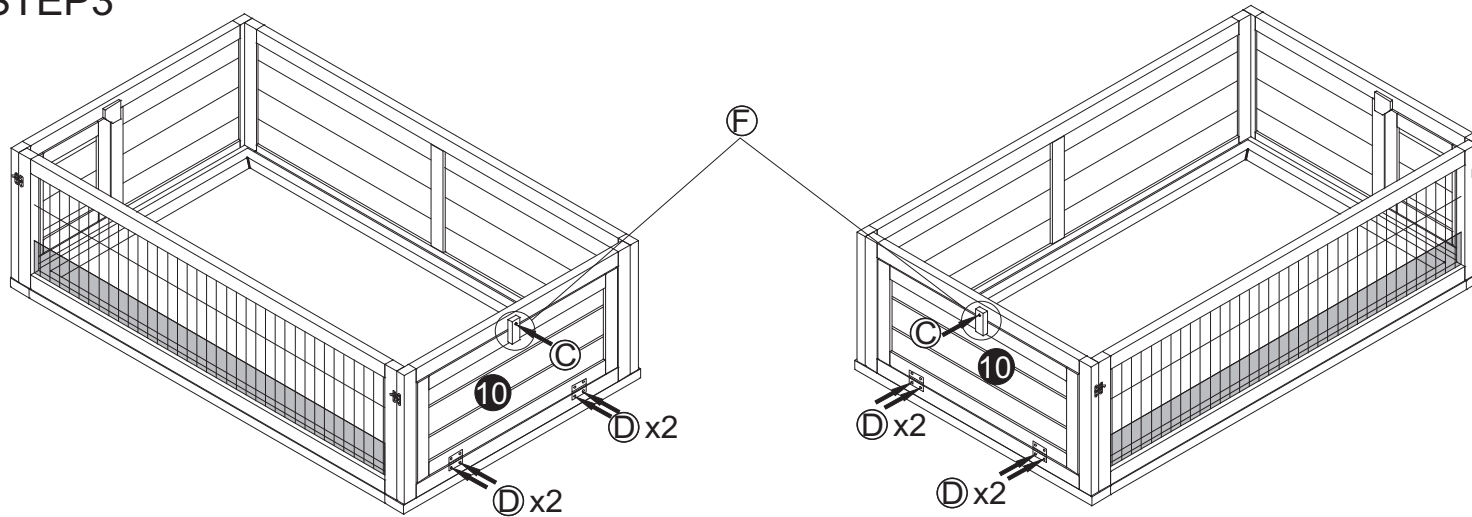

STEP3



- Ⓒ  x2
- Ⓓ  x8
- Ⓕ  x2